

Agilent HLMP-4100/4101

T-1³/₄ (5 mm)

Double Heterojunction AlGaAs

Very High Intensity Red LED Lamps

Data Sheet

Description

These solid state LED lamps utilize newly developed double heterojunction (DH) AlGaAs/GaAs material technology. This LED material has outstanding light output efficiency over a wide range of drive currents. The lamp package has a tapered lens designed to

concentrate the luminous flux into a narrow radiation pattern to achieve a very high intensity. The LED color is deep red at the dominant wavelength of 637 nanometers. These lamps may be DC or pulse driven to achieve desired light output.

Features

- 1000 mcd at 20 mA
- Very high intensity at low drive currents
- Narrow viewing angle
- Outstanding material efficiency
- Low forward voltage
- CMOS/MOS compatible
- TTL compatible
- Deep red color

Applications

- Bright ambient lighting conditions
- Emitter/detector and signaling applications
- General use

Package Dimensions

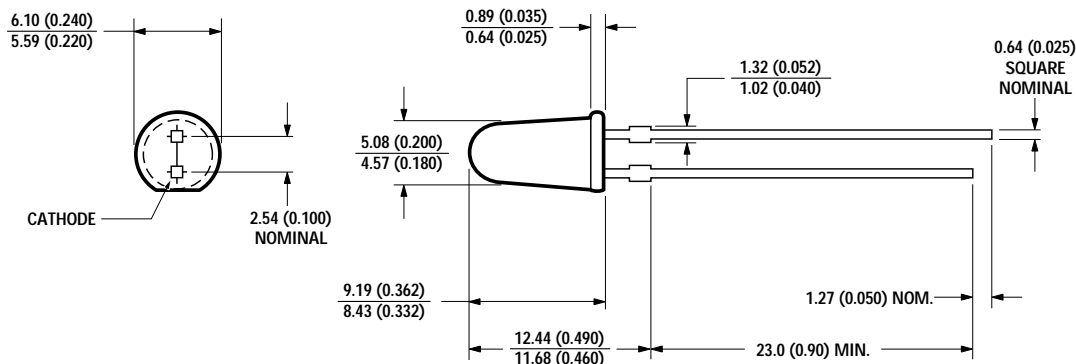

Selection Guide

Device HLMP-	Luminous Intensity Iv (mcd) at 20 mA			2θ _{1/2} ^[1] Degree
	Min.	Typ.	Max.	
4100	500.0	750.0	–	8
4101	700.0	1000.0	–	8
4101-ST0xx	1400.0	2700.0	4000.0	8

Note:

1. θ^{1/2} is the angle from optical centerline where the luminous intensity is 1/2 the optical centerline value.

Part Numbering System

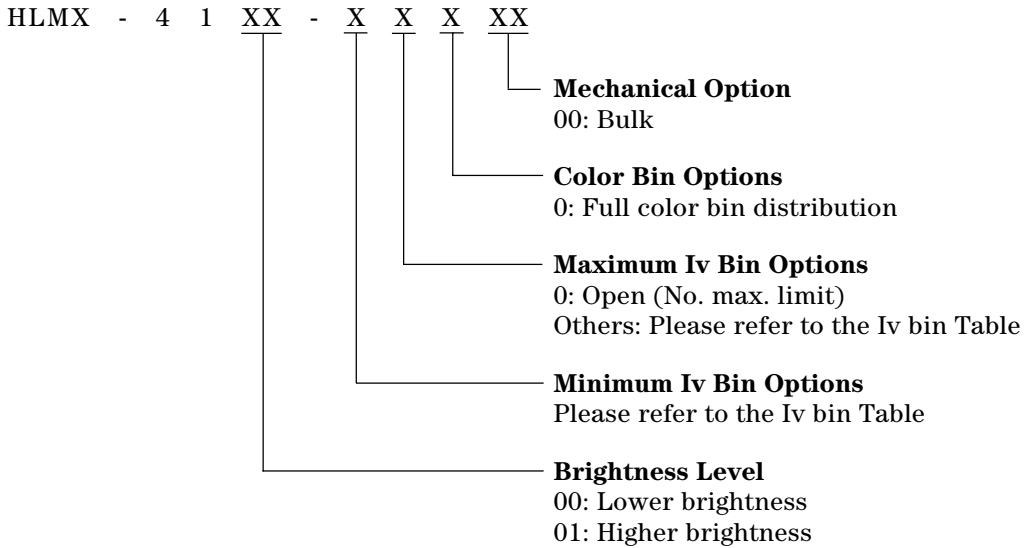

Notes:

1. '0' indicates no maximum intensity limit.
2. '0' indicates full color distribution.

Absolute Maximum Ratings at $T_A = 25^\circ\text{C}$

Parameter	Maximum Rating	Units
Peak Forward Current ^[1, 2]	300	mA
Average Forward Current ^[2]	20	mA
DC Current ^[3]	30	mA
Power Dissipation	87	mW
Reverse Voltage ($I_R = 100 \mu\text{A}$)	5	V
Transient Forward Current (10 μs Pulse) ^[4]	500	mA
Operating Temperature Range	-20 to +100	$^\circ\text{C}$
Storage Temperature Range	-55 to +100	$^\circ\text{C}$
Wave Soldering Temperature [1.59 mm (0.063 in.) from body]	250 $^\circ\text{C}$ for 3 seconds	
Lead Solder Dipping Temperature [1.59 mm (0.063 in.) from body]	260 $^\circ\text{C}$ for 5 seconds	

Notes:

1. Maximum I_{PEAK} at $f = 1 \text{ kHz}$, $\text{DF} = 6.7\%$.
2. Refer to Figure 6 to establish pulsed operating conditions.
3. Derate linearly as shown in Figure 5.
4. The transient peak current is the maximum non-recurring peak current the device can withstand without damaging the LED die and wire bonds. It is not recommended that the device be operated at peak currents beyond the Absolute Maximum Peak Forward Current.

Electrical/Optical Characteristics at $T_A = 25^\circ\text{C}$

Symbol	Description	Min.	Typ.	Max.	Unit	Test Condition
V_F	Forward Voltage		1.8	2.2	V	20 mA
V_R	Reverse Breakdown Voltage	5.0	15.0		V	$I_R = 100 \mu\text{A}$
λ_{PEAK}	Peak Wavelength		650		nm	Measurement at peak
λ_d	Dominant Wavelength		642		nm	Note 1
$\Delta\lambda_{1/2}$	Spectral Line Halfwidth		20		nm	
τ_S	Speed of Response		30		ns	Exponential Time Constant, $e^{-1/2}$
C	Capacitance		30		pF	$V_F = 0$, $f = 1 \text{ MHz}$
θ_{JC}	Thermal Resistance		220		$^\circ\text{C}/\text{W}$	Junction to Cathode Lead
η_V	Luminous Efficacy		80		1 m/W	Note 2

Notes:

1. The dominant wavelength, λ_d , is derived from the CIE chromaticity diagram and represents the color of the device.
2. The radiant intensity, I_e , in watts per steradian, may be found from the equation $I_e = I_V/\eta_V$, where I_V is the luminous intensity in candelas and η_V is luminous efficacy in lumens/watt.
3. The approximate total luminous flux output within a cone angle of 2θ about the optical axis, $\phi_V(2\theta)$, may be obtained from the following formula:
 $\phi_V(2\theta) = [\phi_V(\theta)/I_V(0)]I_V$; Where: $\phi_V(\theta)/I_V(0)$ is obtained from Figure 7.

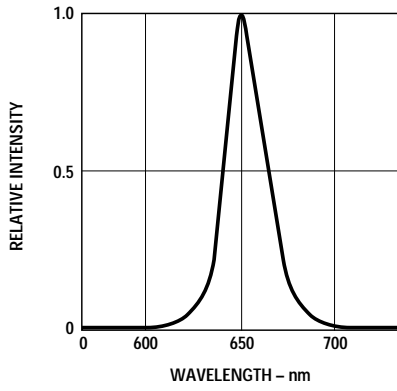

Figure 1. Relative intensity vs. wavelength.

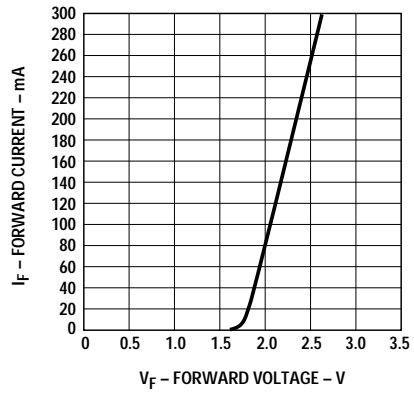

Figure 2. Forward current vs. forward voltage.

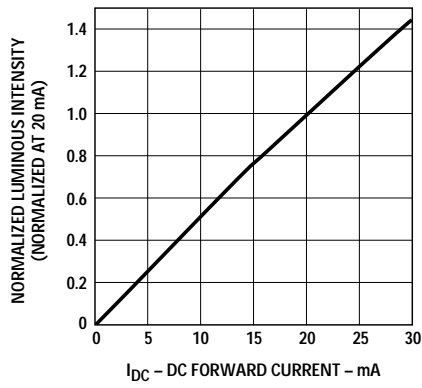

Figure 3. Relative luminous intensity vs. dc forward current.

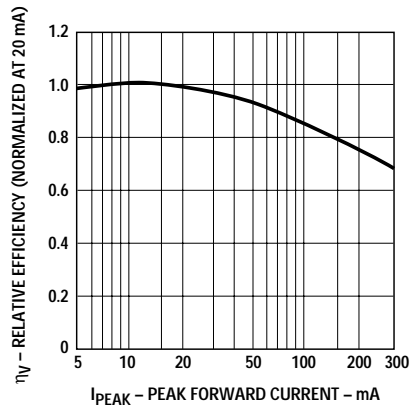

Figure 4. Relative efficiency vs. peak forward current.

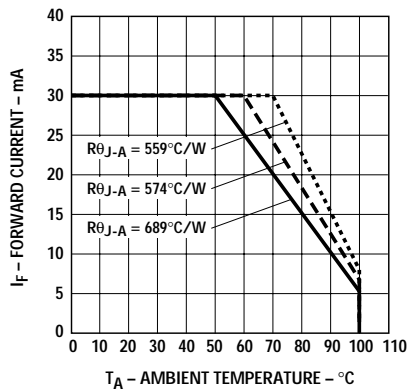

Figure 5. Maximum forward dc current vs. ambient temperature derating based on $T_J \text{ MAX.} = 110^\circ\text{C}$.

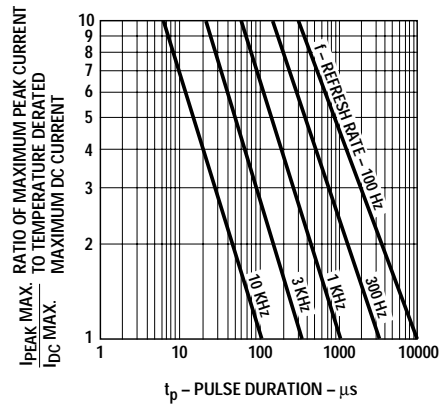

Figure 6. Maximum tolerable peak current vs. peak duration ($I_{\text{PEAK MAX.}}$ determined from temperature derated $I_{\text{DC MAX.}}$).

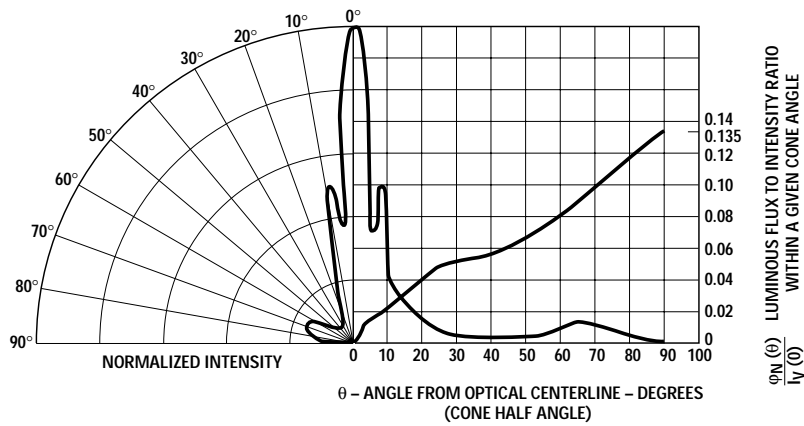

Figure 7. Relative luminous intensity vs. angular displacement.

Intensity Bin Limits

Color	Bin	Intensity Range (mcd)	
		Min.	Max.
Red	P	540.0	850.0
	Q	850.0	1200.0
	R	1200.0	1700.0
	S	1700.0	2400.0
	T	2400.0	3400.0
	U	3400.0	4900.0
	V	4900.0	7100.0
	W	7100.0	10200.0
	X	10200.0	14800.0
	Y	14800.0	21400.0
Z	21400.0	30900.0	

Tolerance for each bin limit is $\pm 18\%$.

Mechanical Option Matrix

Mechanical Option Code	Definition
00	Bulk Packaging, minimum increment 500 pcs/bag

Note:

All categories are established for classification of products. Products may not be available in all categories. Please contact your local Agilent representative for further clarification/information.

www.agilent.com/semiconductors

For product information and a complete list of distributors, please go to our web site.

For technical assistance call:

Americas/Canada: +1 (800) 235-0312 or (916) 788-6763

Europe: +49 (0) 6441 92460

China: 10800 650 0017

Hong Kong: (+65) 6756 2394

India, Australia, New Zealand: (+65) 6755 1939

Japan: (+81 3) 3335-8152 (Domestic/International), or 0120-61-1280 (Domestic Only)

Korea: (+65) 6755 1989

Singapore, Malaysia, Vietnam, Thailand, Philippines, Indonesia: (+65) 6755 2044

Taiwan: (+65) 6755 1843

Data subject to change.

Copyright © 2004 Agilent Technologies, Inc.

Obsoletes 5966-0969E

November 11, 2004

5988-2228EN



Agilent Technologies