

Agilent HSMx-C280 Miniature ChipLED

Data Sheet

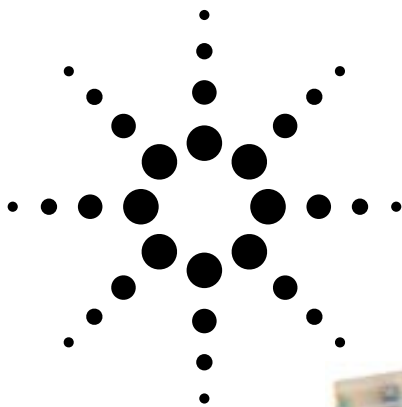

Description

The HSMx-C280 ChipLEDs are designed to 0402 (1.0 x 0.5 mm) industry standard footprint. They are extremely small in size and the low 0.4 mm height makes them very suitable for application in small portable hand held devices where real estate is a premium.

Six different colors are available: green, red, yellow, orange, amber, and deep red. All parts are color and intensity binned except red color. They come in 8 mm paper tape on a 7 inch diameter reel with 4000 units per reel which makes them compatible for automatic placement.

Features

- Extremely small size (1.0 x 0.5 x 0.4 mm)
- 0402 industry standard footprint
- Diffused optics
- Operating temperature range of -30°C to $+85^{\circ}\text{C}$
- Compatible with IR soldering
- Available in 6 colors
- Available in 8 mm paper tape on 7" diameter reel
- Reel sealed in zip locked moisture barrier bags

Applications

- LCD backlighting
- Push button backlighting
- Front panel indicator
- Symbol backlighting
- Keypad backlighting

Device Selection Guide

AS AlInGaP

Product Number	Color	Package Description
HSMA-C280	Amber	Untinted, Diffused
HSMC-C280	Red	Untinted, Diffused
HSML-C280	Orange	Untinted, Diffused
HSMT-C280	Deep Red	Untinted, Diffused

GaP

Product Number	Color	Package Description
HSMG-C280	Green	Untinted, Diffused
HSMD-C280	Orange	Untinted, Diffused
HSMS-C280	HER	Untinted, Diffused
HSMY-C280	Yellow	Untinted, Diffused



Package Dimensions

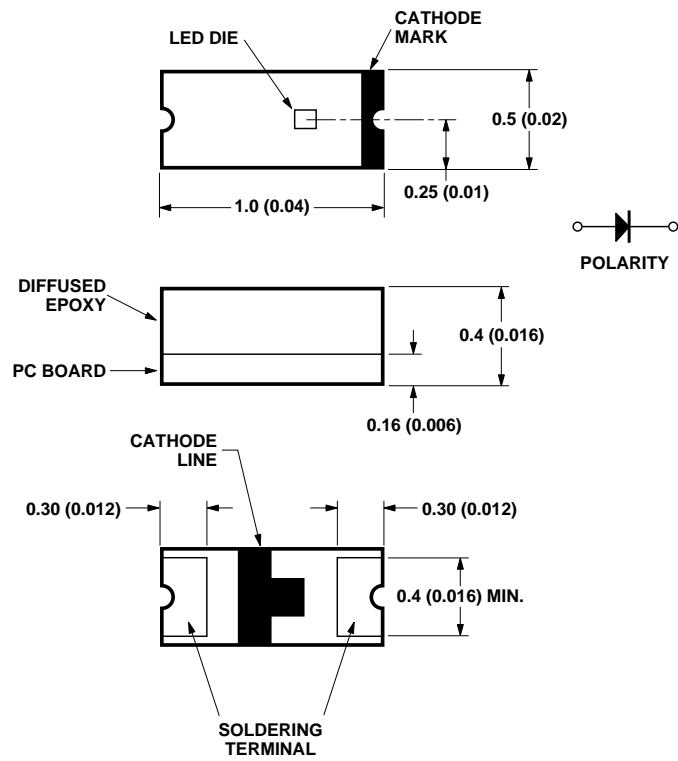

NOTES:

1. ALL DIMENSIONS IN MILLIMETERS (INCHES).
2. TOLERANCE IS ± 0.1 mm (± 0.004 IN.) UNLESS OTHERWISE SPECIFIED.

Absolute Maximum Ratings at T_A = 25°C

Parameter	HSMA/C/L/T-C280	HSMG/D/S/Y-C280	Units
DC Forward Current ^[1]	25	20	mA
Peak Pulsing Current ^[2]	100	100	mA
Power Dissipation	75	52	mW
Reverse Voltage (I _R = 100 μA)	5	5	V
LED Junction Temperature	95	95	°C
Operating Temperature Range	-30 to +85	-30 to +85	°C
Storage Temperature Range	-40 to +85	-40 to +85	°C
Soldering Temperature	See IR soldering profile (Figure 7)		

Notes:

1. Derate linearly as shown in Figure 4.
2. Pulse condition of 1/10 duty and 0.1 ms width.

Electrical Characteristics at T_A = 25°C

Part Number	Forward Voltage V _F (Volts) @ I _F = 20 mA		Reverse Breakdown V _R (Volts) @ I _R = 100 μA	Capacitance C (pF), V _F = 0, f = 1 MHz	Thermal Resistance R _{θJ-PIN} (°C/W)
	Typ.	Max.	Min.	Typ.	Typ.
HSMA-C280	1.9	2.4	5	11	300
HSMC-C280	1.9	2.4	5	15	300
HSML-C280	1.9	2.4	5	20	300
HSMT-C280	1.9	2.4	5	15	300
HSMG-C280	2.2	2.6	5	9	250
HSMD-C280	2.2	2.6	5	7	250
HSMS-C280	2.1	2.6	5	5	250
HSMY-C280	2.1	2.6	5	6	250

Optical Characteristics at T_A = 25°C

Part Number	Color	Luminous Intensity I _V (mcd) @ 20 mA ^[1]		Peak Wavelength λ _{peak} (nm)	Color, Dominant Wavelength λ _d ^[2] (nm)	Viewing Angle 2 θ _{1/2} Degrees ^[3]	Luminous Efficacy η _v (lm/w)
		Min.	Typ.	Typ.	Typ.	Typ.	Typ.
HSMA-C280	AS Amber	25	90	595	592	130	480
HSMC-C280	AS Red	25	90	637	626	130	155
HSML-C280	AS Orange	25	90	609	605	130	370
HSMT-C280	AS Deep Red	10	30	660	639	130	70
HSMG-C280	GaP Green	4.0	15	570	572	130	595
HSMD-C280	GaP Orange	2.5	8	605	604	130	380
HSMS-C280	HER	2.5	10	630	626	130	145
HSMY-C280	GaP Yellow	2.5	8	589	586	130	500

Notes:

1. The luminous intensity, I_v, is measured at the peak of the spatial radiation pattern which may not be aligned with the mechanical axis of the lamp package.
2. The dominant wavelength, λ_d, is derived from the CIE Chromatically Diagram and represents the perceived color of the device.
3. θ_{1/2} is the off-axis angle where the luminous intensity is 1/2 the peak intensity.

Color Bin Limits^[1]

Green Color Bins^[1]		
Dom. Wavelength (nm)		
Bin ID	Min.	Max.
A	561.5	564.5
B	564.5	567.5
C	567.5	570.5
D	570.5	573.5
E	573.5	576.5

Tolerance: ±0.5 nm.

Orange Color Bins^[1]		
Dom. Wavelength (nm)		
Bin ID	Min.	Max.
A	597.0	600.0
B	600.0	603.0
C	603.0	606.0
D	606.0	609.0
E	609.0	612.0
F	612.0	615.0

Tolerance: ±1 nm.

Yellow/Amber Color Bins^[1]		
Dom. Wavelength (nm)		
Bin ID	Min.	Max.
A	582.0	584.5
B	584.5	587.0
C	587.0	589.5
D	589.5	592.0
E	592.0	594.5
F	594.5	597.0

Tolerance: ±0.5 nm.

Note:

1. Bin categories are established for classification of products. Products may not be available in all categories. Please contact your Agilent representative for information on currently available bins.

Light Intensity (Iv) Bin Limits^[1]

Intensity (mcd)		
Bin ID	Min.	Max.
A	0.11	0.18
B	0.18	0.29
C	0.29	0.45
D	0.45	0.72
E	0.72	1.10
F	1.10	1.80
G	1.80	2.80
H	2.80	4.50
J	4.50	7.20
K	7.20	11.20
L	11.20	18.00
M	18.00	28.50
N	28.50	45.00
P	45.00	71.50
Q	71.50	112.50
R	112.50	180.00
S	180.00	285.00
T	285.00	450.00
U	450.00	715.00
V	715.00	1125.00
W	1125.00	1800.00
X	1800.00	2850.00
Y	2850.00	4500.00

Tolerance: ±15%

Note:

1. Bin categories are established for classification of products. Products may not be available in all categories. Please contact your Agilent representative for information on currently available bins.

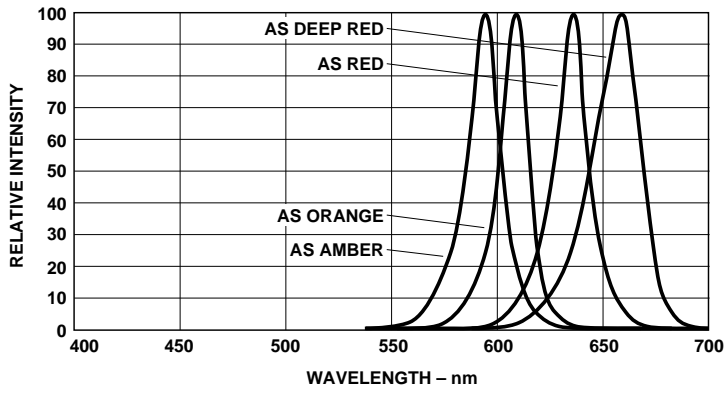

Figure 1a. Relative intensity vs. wavelength.

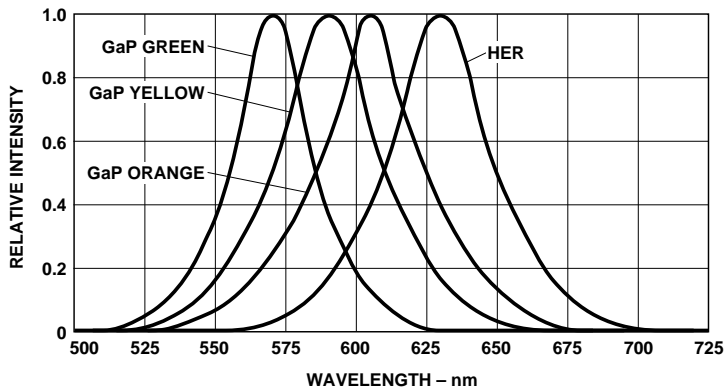

Figure 1b. Relative intensity vs. wavelength.

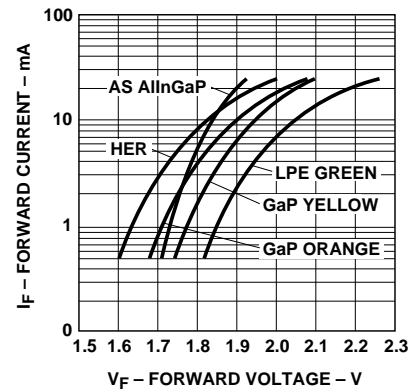

Figure 2. Forward current vs. forward voltage.

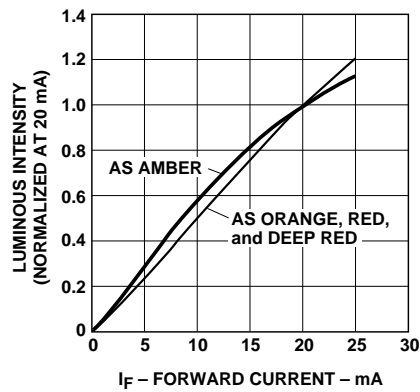
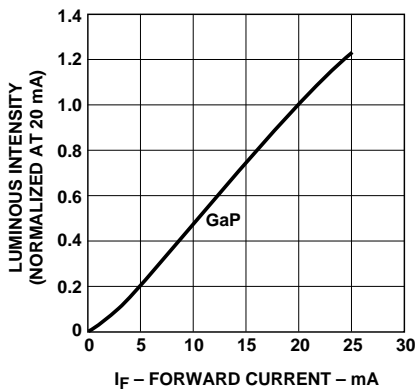

Figure 3. Luminous intensity vs. forward current.

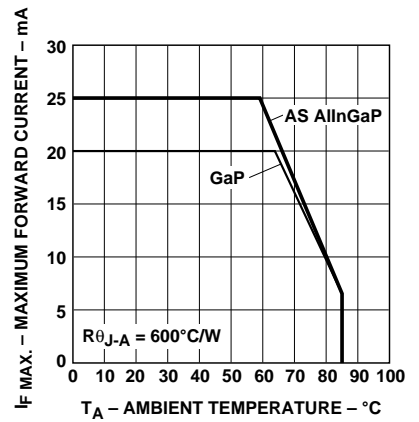

Figure 4. Maximum forward current vs. ambient temperature.

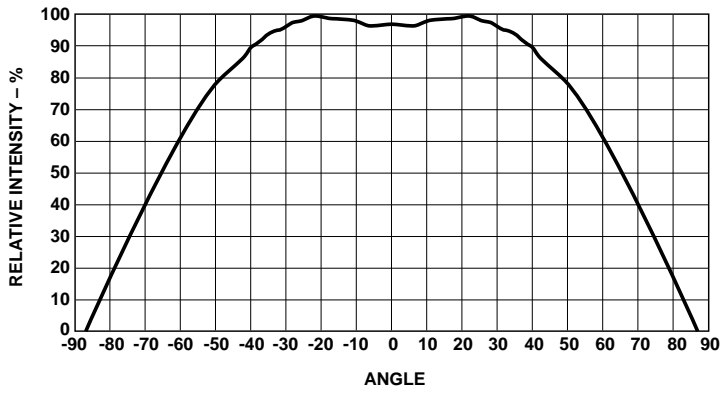

Figure 5. Relative intensity vs. angle.

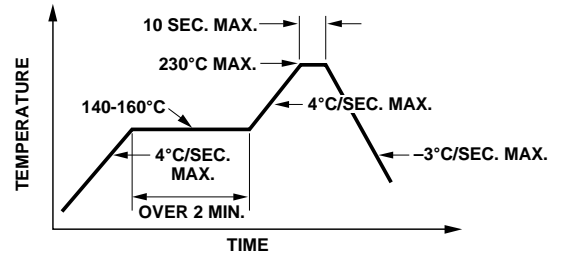

Figure 6. Recommended reflow soldering profile.

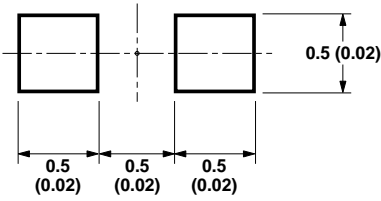

Figure 7. Recommended soldering pattern for HSMx-C280.

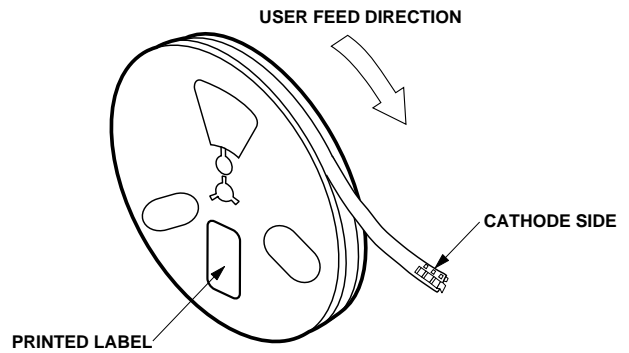

Figure 8. Reeling orientation.

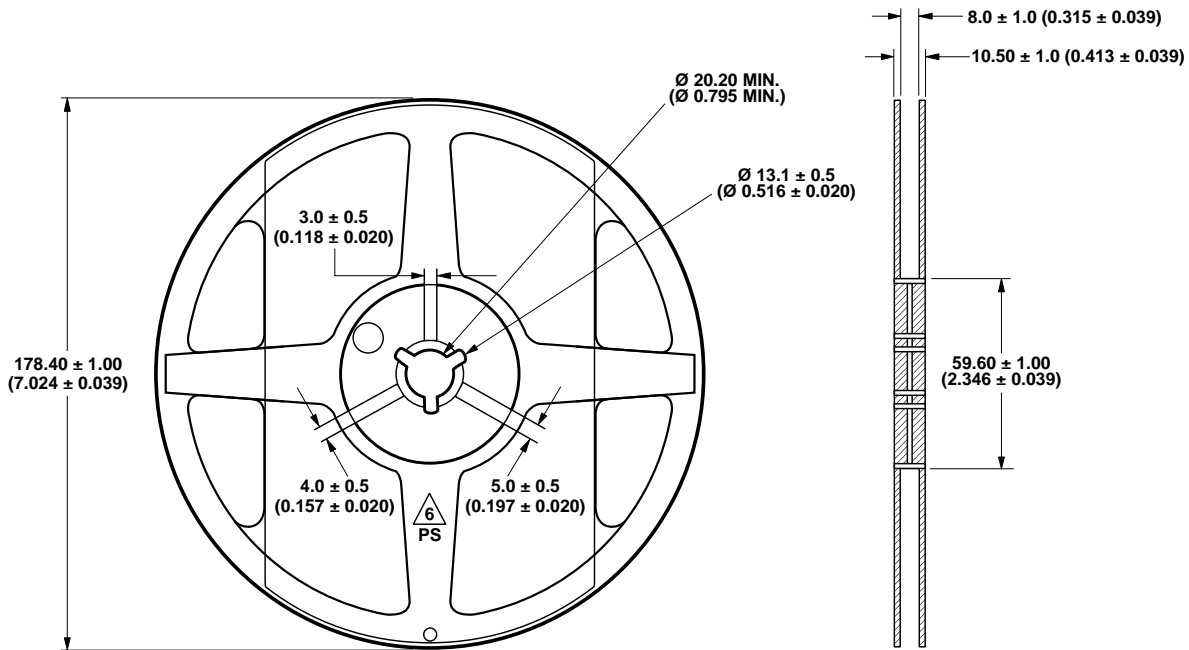

Figure 9. Reel dimensions.

NOTE:

1. ALL DIMENSIONS IN MILLIMETERS (INCHES).

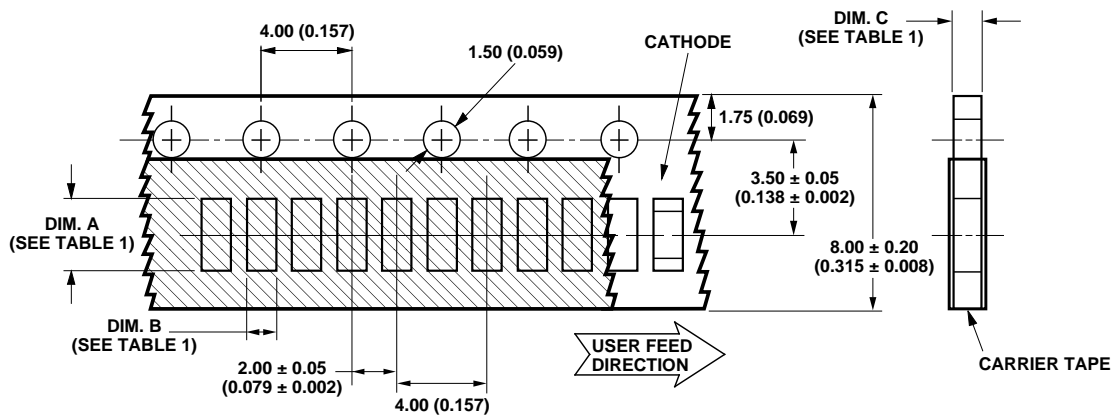

TABLE 1
DIMENSIONS IN MILLIMETERS (INCHES)

PART NUMBER	DIM. A ± 0.1 (± 0.004)	DIM. B ± 0.1 (± 0.004)	DIM. C ± 0.10 (± 0.004)
HSMx-C280 SERIES	1.15 (0.045)	0.65 (0.026)	0.60 (0.024)

Figure 10. Tape dimensions.

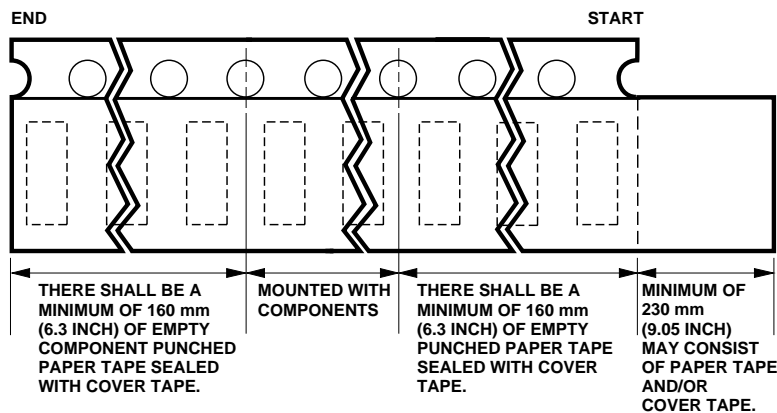

Figure 11. Tape leader and trailer dimensions.

NOTES:

- ALL DIMENSIONS IN MILLIMETERS (INCHES).
- TOLERANCE IS ± 0.1 mm (± 0.004 IN.) UNLESS OTHERWISE SPECIFIED.

Convective IR Reflow Soldering

For more information on IR reflow soldering, refer to Application Note 1060, *Surface Mounting SMT LED Indicator Components*.

Storage Condition:

5 to 30°C @ 60% RH max.

Baking is required under the condition:

- the blue silica gel indicator becoming white/transparent color
- the pack has been open for more than 1 week

Baking recommended condition:
60 ± 5°C for 20 hours.

www.agilent.com/semiconductors

For product information and a complete list of distributors, please go to our web site.

For technical assistance call:

Americas/Canada: +1 (800) 235-0312 or
(408) 654-8675

Europe: +49 (0) 6441 92460

China: 10800 650 0017

Hong Kong: (+65) 271 2451

India, Australia, New Zealand: (+65) 271 2394

Japan: (+81 3) 3335-8152(Domestic/International), or 0120-61-1280(Domestic Only)

Korea: (+65) 271 2194

Malaysia, Singapore: (+65) 271 2054

Taiwan: (+65) 271 2654

Data subject to change.

Copyright © 2002 Agilent Technologies, Inc.

Obsoletes 5988-3184EN

March 7, 2002

5988-5890EN



Agilent Technologies