



16K x 4 SRAM
SRAM MEMORY ARRAY

AVAILABLE AS MILITARY SPECIFICATIONS

- SMD 5962-86859
- SMD 5962-89692
- MIL-STD-883

FEATURES

- Speeds: 12, 15, 20, 25, 35, 45, 55, and 70ns
- Battery Backup: 2V data retention
- High-performance, low-power CMOS double-metal process
- Single +5V ($\pm 10\%$) Power Supply
- Easy memory expansion with CE\
- All inputs and outputs are TTL compatible

OPTIONS

• **Timing**

12ns access	-12
15ns access	-15
20ns access	-20
25ns access	-25
35ns access	-35
45ns access	-45*
55ns access	-55*
70ns access	-70*

• **Package(s)**

Ceramic DIP (300 mil)	C	No. 105
-----------------------	---	---------

• **Operating Temperature Ranges**

Industrial (-40°C to +85°C)	IT
Military (-55°C to +125°C)	XT

- 2V data retention/low power L

*Electrical characteristics identical to those provided for the 35ns access devices.

PIN ASSIGNMENT
(Top View)

22-Pin DIP (C)
(300 MIL)

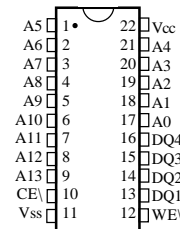

GENERAL DESCRIPTION

The Austin Semiconductor SRAM family employs high-speed, low-power CMOS designs using a four-transistor memory cell. Austin Semiconductor SRAMs are fabricated using double-layer metal, double-layer polysilicon technology.

For flexibility in high-speed memory applications, Austin Semiconductor offers chip enable (CE\) on all organizations. This enhancement can place the outputs in High-Z for additional flexibility in system design.

Writing to these devices is accomplished when write enable (WE\) and CE\ inputs are both LOW. Reading is accomplished when WE\ remains HIGH and CE\ goes LOW. The device offers a reduced power standby mode when disabled. This allows system designs to achieve low standby power requirements.

All devices operate from a single +5V power supply and all inputs and outputs are fully TTL compatible.

**For more products and information
please visit our web site at
www.austinsemiconductor.com**



FUNCTIONAL BLOCK DIAGRAM

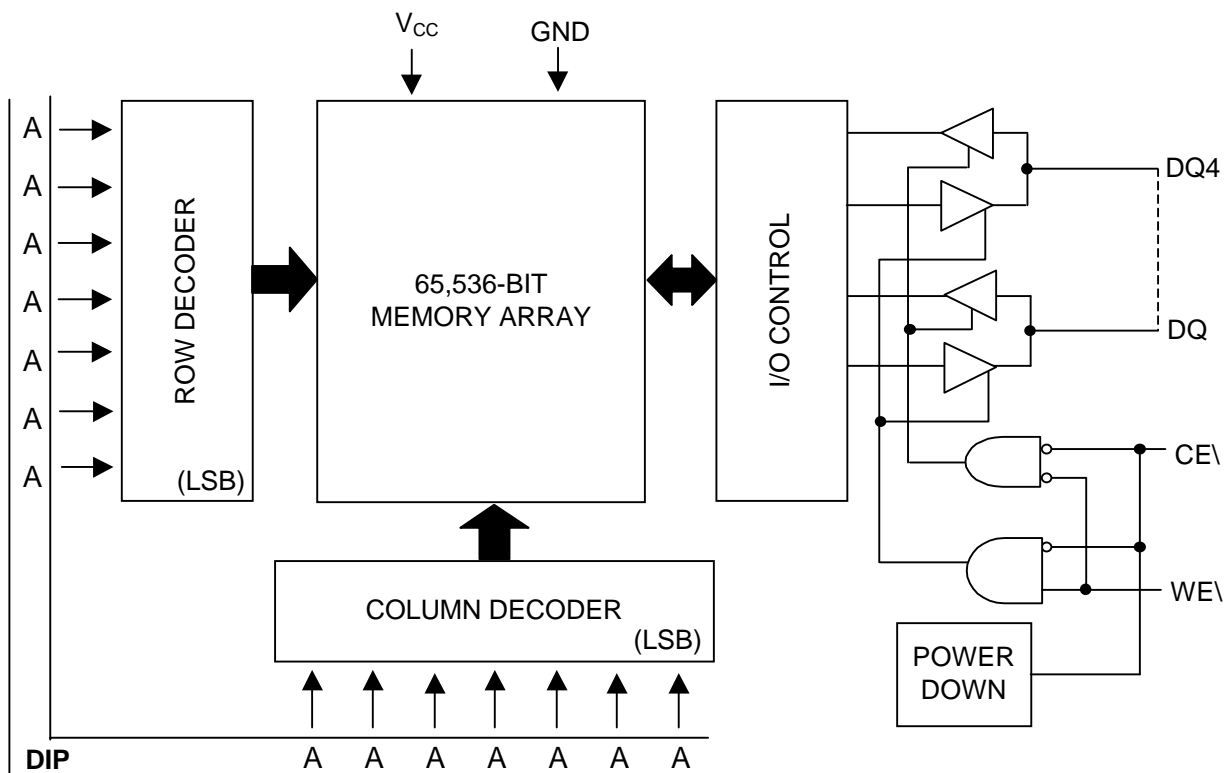

TRUTHTABLE

MODE	CE\	WE\	DQ	POWER
STANDBY	H	X	HIGH-Z	STANDBY
READ	L	H	Q	ACTIVE
WRITE	L	L	D	ACTIVE



ABSOLUTE MAXIMUM RATINGS*

Voltage on any Input or DQ Relative to Vss...-2.0V to +7.0V
 Voltage on Vcc Supply Relative to Vss.....-1.0V to +7.0V
 Storage Temperature.....-65°C to +150°C
 Power Dissipation.....1W
 Max Junction Temperature.....+175°C
 Lead Temperature (soldering 10 seconds).....+260°C
 Short Circuit Output Current.....50mA

*Stresses greater than those listed under "Absolute Maximum Ratings" may cause permanent damage to the device. This is a stress rating only and functional operation of the device at these or any other conditions above those indicated in the operation section of this specification is not implied. Exposure to absolute maximum rating conditions for extended periods may affect reliability.

ELECTRICAL CHARACTERISTICS AND RECOMMENDED DC OPERATING CONDITIONS

(-55°C ≤ T_c ≤ 125°C; V_{cc} = 5V ±10%)

DESCRIPTION	CONDITIONS	SYM	MIN	MAX	UNITS	NOTES
Input High (Logic 1) Voltage		V _{IH}	2.2	V _{cc} +1.0V	V	1
Input Low (Logic 0) Voltage		V _{IL}	-0.5	0.8	V	1, 2
Input Leakage Current	0V ≤ V _{IN} ≤ V _{CC}	I _{LI}	-10	10	µA	
Output Leakage Current	Outputs Disabled 0V ≤ V _{OUT} ≤ V _{CC}	I _{LO}	-10	10	µA	
Output High Voltage	I _{OH} = -4.0mA	V _{OH}	2.4	---	V	1
Output Low Voltage	I _{OL} = 8.0mA	V _{OL}	---	0.4	V	1

PARAMETER	CONDITIONS	SYM	MAX					UNITS	NOTES
			-12	-15	-20	-25	-35		
Power Supply Current: Operating	CE \ ≤ V _{IL} ; V _{CC} = MAX Output Open	I _{CC}	140	125	110	100	90	mA	3
Power Supply Current: Standby	CE \ ≥ V _{IH} ; V _{CC} = MAX f = 1/t _{RC} (MIN) Hz	I _{SBT1}	45	41	36	33	30	mA	
	CE \ ≥ V _{IH} ; All Other Inputs ≤ V _{IL} or ≥ V _{IH} ; V _{CC} = MAX f = 0 Hz	I _{SBT2}	25	25	25	25	25	mA	
	CE \ ≥ (V _{CC} - 0.2); V _{CC} = MAX All Other Inputs ≤ 0.2V or ≥ (V _{CC} - 0.2V), f = 0 Hz	I _{SBC2}	5	5	5	5	5	mA	

CAPACITANCE

DESCRIPTION	CONDITIONS	SYM	MAX	UNITS	NOTES
Input Capacitance	T _A = 25°C, f = 1MHz V _{cc} = 5V	C _I	6	pF	4
Output Capacitance		C _O	7	pF	4



ELECTRICAL CHARACTERISTICS AND RECOMMENDED AC OPERATING CONDITIONS

(Note 5) ($-55^{\circ}\text{C} \leq T_c \leq 125^{\circ}\text{C}$; $V_{cc} = 5V \pm 10\%$)

DESCRIPTION	SYMBOL	-12		-15		-20		-25		-35		UNITS	NOTES
		MIN	MAX	MIN	MAX	MIN	MAX	MIN	MAX	MIN	MAX		
READ CYCLE													
READ cycle time	t_{RC}	12		15		20		25		35		ns	
Address access time	t_{AA}		12		15		20		25		35	ns	
Chip Enable access time	t_{ACE}		10		13		15		20		25	ns	
Output hold from address change	t_{OH}	2		2		2		2		2		ns	
Chip Enable to output in Low-Z	t_{LZCE}	2		2		2		2		2		ns	7
Chip disable to output in High-Z	t_{HZCE}		7		8		10		12		15	ns	6, 7
Chip Enable to power-up time	t_{PU}	0		0		0		0		0		ns	
Chip disable to power-down time	t_{PD}		12		15		20		25		35	ns	
WRITE CYCLE													
WRITE cycle time	t_{WC}	12		15		20		25		35		ns	
Chip Enable to end of write	t_{CW}	10		12		15		20		25		ns	
Address valid to end of write	t_{AW}	10		12		15		20		25		ns	
Address setup time	t_{AS}	0		0		0		0		0		ns	
Address hold from end of write	t_{AH}	0		0		0		0		0		ns	
WRITE pulse width	t_{WP}	10		12		15		20		25		ns	
Data setup time	t_{DS}	7		8		10		12		15		ns	
Data hold time	t_{DH}	0		0		0		0		0		ns	
Write disable to output in Low-Z	t_{LZWE}	2		2		2		2		2		ns	7
Write Enable to output in High-Z	t_{HZWE}	0	6	0	7	0	8	0	10	0	15	ns	6, 7



ACTEST CONDITIONS

Input pulse levels	V _{ss} to 3.0V
Input rise and fall times	5ns
Input timing reference levels	1.5V
Output reference levels	1.5V
Output load	See Figures 1 and 2

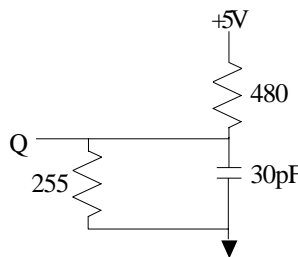

Fig. 1 Output Load Equivalent

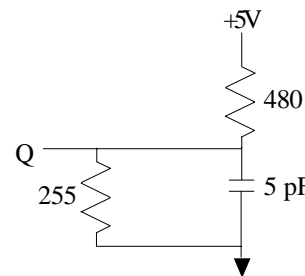

Fig. 2 Output Load Equivalent

NOTES

- All voltages referenced to V_{ss} (GND).
- 3V for pulse width < 20ns
- I_{CC} is dependent on output loading and cycle rates. The specified value applies with the outputs unloaded, and $f = \frac{1}{RC}$ Hz.
- This parameter is sampled.
- Test conditions as specified with the output loading as shown in Fig. 1 unless otherwise noted.
- t_{HZCE} and t_{HZWE} are specified with CL = 5pF as in Fig. 2. Transition is measured ±500mV typical from steady state voltage, allowing for actual tester RC time constant.

- At any given temperature and voltage condition, t_{HZCE} is less than t_{LZCE}, and t_{HZWE} is less than t_{LZWE}.
- WE\ is HIGH for READ cycle.
- Device is continuously selected. Chip enable is held in its active state.
- Address valid prior to, or coincident with, latest occurring chip enable.
- RC = READ Cycle Time.
- Chip enable (CE\) and write enable (WE\) can initiate and terminate a WRITE cycle.

DATA RETENTION ELECTRICAL CHARACTERISTICS (L Version Only)

DESCRIPTION	CONDITIONS	SYM	MIN	MAX	UNITS	NOTES
V _{CC} for Retention Data		V _{DR}	2	---	V	
Data Retention Current	CE\ ≥ (V _{CC} - 0.2V) V _{IN} ≥ (V _{CC} - 0.2V) or ≤ 0.2V	V _{CC} = 2V I _{CCDR}	---	300	μA	
		V _{CC} = 3V I _{CCDR}	---	500	μA	
Chip Deselect to Data Retention Time		t _{CDR}	0	---	ns	4
Operation Recovery Time		t _R	t _{RC}	---	ns	4, 11

LOW V_{CC} DATA RETENTION WAVEFORM

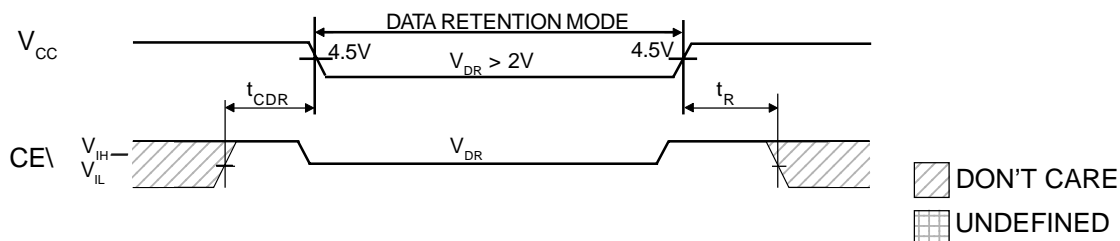



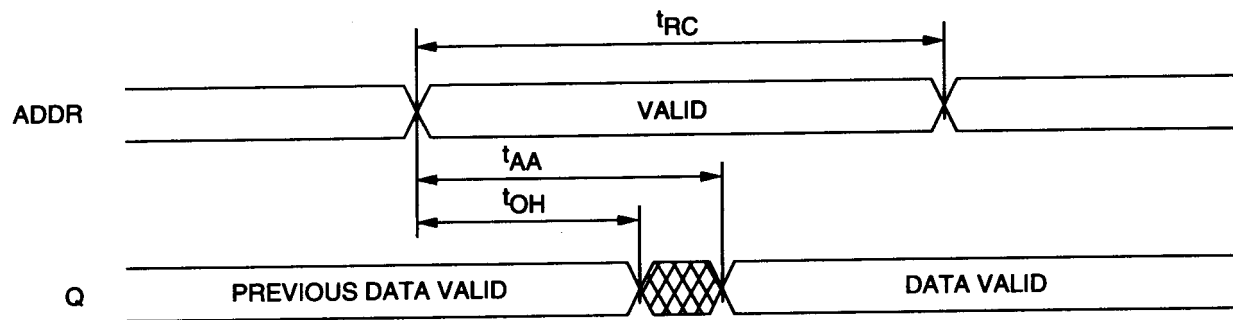

READ CYCLE NO. 1 ^{8,9}

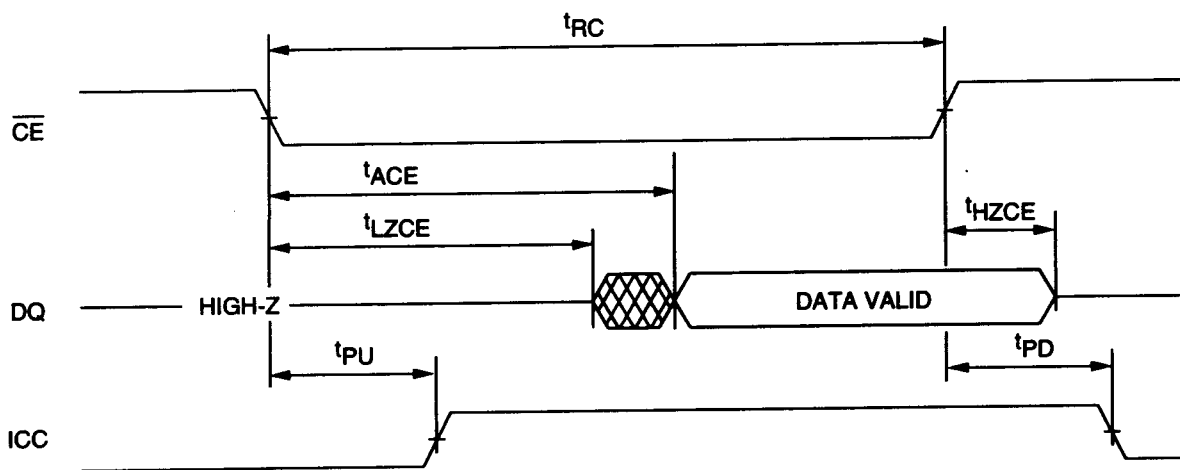

READ CYCLE NO. 2 ^{7,8,10}



 DON'T CARE
 UNDEFINED



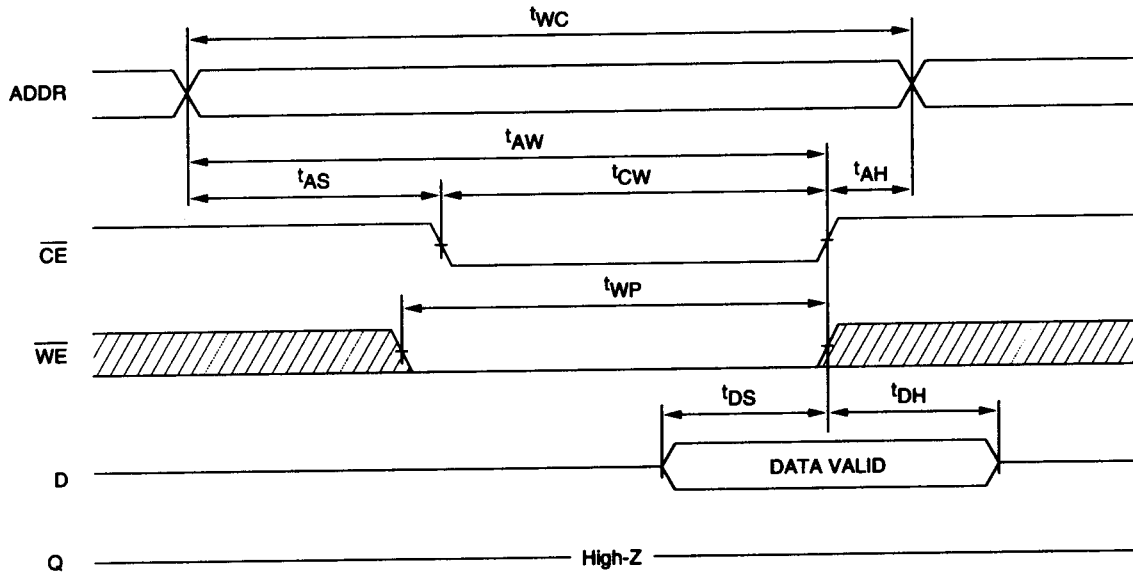

WRITE CYCLE NO. 1 ¹²
(Chip Enabled Controlled)

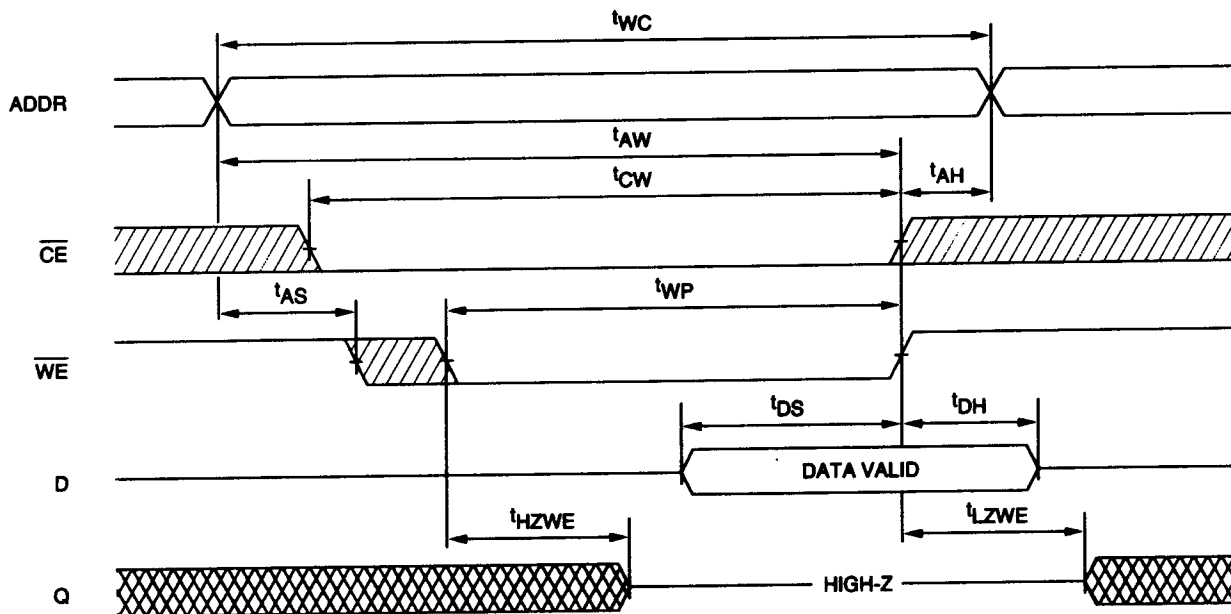

WRITE CYCLE NO. 2 ^{7, 12, 13}
(Write Enabled Controlled)



 DON'T CARE
 UNDEFINED



MECHANICAL DEFINITIONS*

ASI Case #105 (Package Designator C)
SMD 5962-86859, Case Outline T
SMD 5962-89692, Case Outline X

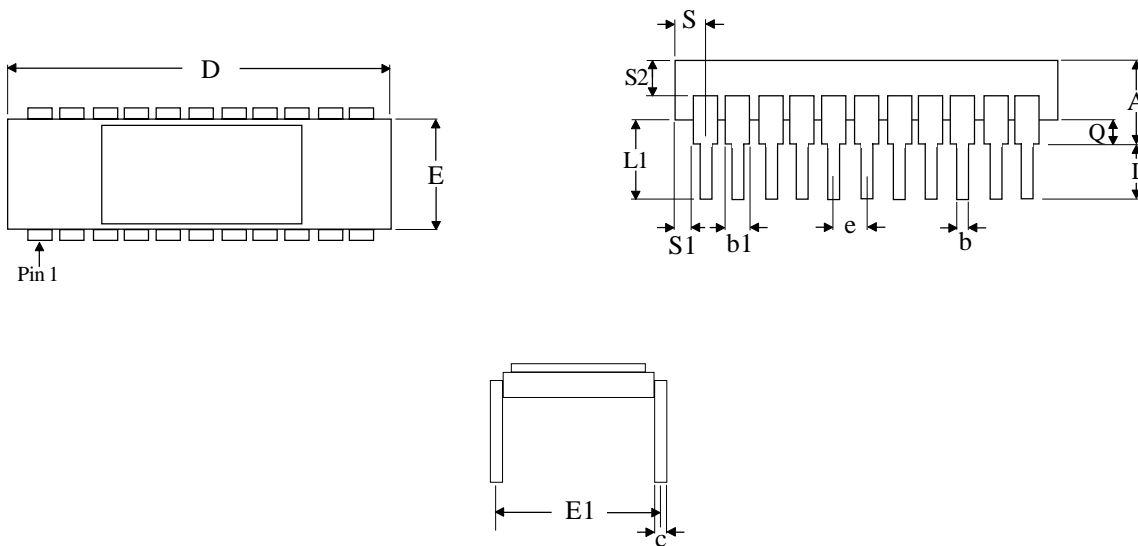

SYMBOL	SMD SPECIFICATIONS	
	MIN	MAX
A	0.100	0.200
b	0.014	0.023
b1	0.030	0.060
c	0.008	0.015
D	1.050	1.260
E	0.260	0.310
E1	0.280	0.320
e	0.100 BSC	
L	0.125	0.200
L1	0.150	---
Q	0.015	0.060
S	0.030	0.065
S1	0.005	---
S2	0.005	---

NOTE: These dimensions are per the SMD. ASI's package dimensional limits may differ, but they will be within the SMD limits.

* All measurements are in inches.



ORDERING INFORMATION

EXAMPLE: MT5C6404C-25L/XT

Device Number	Package Type	Speed ns	Options**	Process
MT5C6404	C	-12	L	/*
MT5C6404	C	-15	L	/*
MT5C6404	C	-20	L	/*
MT5C6404	C	-25	L	/*
MT5C6404	C	-35	L	/*
MT5C6404	C	-45	L	/*
MT5C6404	C	-55	L	/*
MT5C6404	C	-70	L	/*

*AVAILABLE PROCESSES

IT = Industrial Temperature Range

-40°C to +85°C

XT = Extended Temperature Range

-55°C to +125°C

883C = Full Military Processing

-55°C to +125°C

** OPTIONS

L = 2V Data Retention/Low Power



**ASI TO DSCC PART NUMBER
CROSS REFERENCE***

ASI Package Designator C

SMD 5962-86859

ASI Part #	SMD Part #
MT5C6804C-35/883C	5962-8685924TA
MT5C6804C-35L/883C	5962-8685923TA
MT5C6804C-45/883C	5962-8685922TA
MT5C6804C-45L/883C	5962-8685921TA
MT5C6804C-55/883C	5962-8685920TA
MT5C6804C-55L/883C	5962-8685919TA

SMD 5962-89692

ASI Part #	SMD Part #
MT5C6804C-15/883C	5962-8969202XA
MT5C6804C-20/883C	5962-8969204XA
MT5C6804C-25/883C	5962-8969206XA

* ASI part number is for reference only. Orders received referencing the SMD part number will be processed per the SMD.