

# Energy Management Multifunction indicator Type WM12-96

CARLO GAVAZZI



- Accuracy  $\pm 0.5$  F.S. (current/voltage)
- Multifunction indicator
- Display of instantaneous variables: 3x3 digit
- Variable system and phase measurements: W,  $W_{dmd}$ , var, VA,  $VA_{dmd}$ , PF, V, A, An, Hz
- $A_{max}$ ,  $W_{dmd\ max}$  indication
- TRMS meas. of distorted sine waves (voltages/currents)
- Power supply: 24V, 48V, 115V, 230V, 50-60Hz; 18 to 60VDC
- Protection degree (front): IP65
- Front dimensions: 96x96mm
- Optional RS422/485 serial output
- Alarms (visual only)  $V_{LN}$ , An

## Product Description

3-phase multifunction power indicator with built-in programming key-pad. Particularly recommended for displaying the main electrical variables.

Housing for panel mounting, (front) protection degree IP65 as standard, and optional RS485 serial output.

## How to order

**WM12-96 AV5 3 D X**

Model \_\_\_\_\_  
 Range code \_\_\_\_\_  
 System \_\_\_\_\_  
 Power supply \_\_\_\_\_  
 Option \_\_\_\_\_

## Type Selection

Range codes	System	Power supply	Options
<b>AV5:</b> 380/660V <sub>L-L</sub> /5(6)AAC VL-N: 185 V to 460 V VL-L: 320 V to 800 V <b>AV6:</b> 120/208V <sub>L-L</sub> /5(6)AAC VL-N: 45 V to 145 V VL-L: 78 V to 250 V Phase current: 0.03A to 6A Neutral current: 0.09 to 6A	<b>3 :</b> 1-2-3-phase, unbalanced load, with or without neutral	<b>A:</b> 24VAC -15+10%, 50-60Hz <b>B:</b> 48VAC -15+10%, 50-60Hz <b>C:</b> 115VAC -15+10%, 50-60Hz <b>D:</b> 230VAC -15+10%, 50-60Hz <b>3:</b> 18 to 60VDC	<b>X:</b> None <b>S:</b> RS485 output

## Input specifications

<b>Rated inputs</b> Current Voltage	3 (shunt) 4	<b>Sampling rate</b> 1400 samples/s @ 50Hz 1700 samples/s @ 60Hz
<b>Accuracy</b> (display, RS485) (@25°C $\pm 5^\circ\text{C}$ , R.H. $\leq 60\%$ )	with CT=1 and VT=1 AV5: 1150W-VA-var, FS:230VLN, 400VLL; AV6: 285W-VA-var, FS:57VLN, 100VLL	<b>Display refresh time</b> 700ms
Current Neutral current Phase-phase voltage Phase-neutral voltage Active and Apparent power, Power factor Reactive power Frequency	0.25 to 6A: $\pm(0.5\% \text{ FS} + 1\text{DGT})$ 0.03A to 0.25A: $\pm 7\text{DGT}$ 0.25 to 6A: $\pm(1.5\% \text{ FS} + 1\text{DGT})$ 0.09A to 0.25A: $\pm 7\text{DGT}$ $\pm(1.5\% \text{ FS} + 1 \text{ DGT})$ $\pm(0.5\% \text{ FS} + 1 \text{ DGT})$ 0.25 to 6A: $\pm(1\% \text{ FS} + 1\text{DGT})$ ; 0.03A to 0.25A: $\pm(1\% \text{ FS} + 5\text{DGT})$ 0.25 to 6A: $\pm(2\% \text{ FS} + 1\text{DGT})$ ; 0.03A to 0.25A: $\pm(2\% \text{ FS} + 5\text{DGT})$ $\pm 0.1\% \text{ Hz}$ (48 to 62Hz)	<b>Display</b> Type Read-out for the instant. var. <b>Measurements</b> Current, voltage, power, power factor, frequency TRMS measurement of distorted waves. Coupling type Crest factor Direct $< 3$ , max 10A peak
<b>Additional errors</b> Humidity <b>Temperature drift</b>	$\leq 0.3\% \text{ FS}$ , 60% to 90% RH $\leq 200\text{ppm}/^\circ\text{C}$	<b>Input impedance</b> 380/660V <sub>L-L</sub> (AV5) 120/208V <sub>L-L</sub> (AV6) Current $1 \text{ M}\Omega \pm 5\%$ $453 \text{ K}\Omega \pm 5\%$ $\leq 0.02\Omega$ <b>Frequency</b> 48 to 62 Hz <b>Overload protection</b> Continuous voltage/current For 500ms: voltage/current 1.2 F.S. 2 Un/36A



## RS485 Serial Output Specifications

<b>RS422/RS485</b> (on request)		Data (bidirectional) Dynamic (reading only) Static (writing only)	System and phase variables All configuration parameters 1 bit di start , 8 data bit, no parity, 1 stop bit 9600 bit/s
Type	Multidrop bidirectional (static and dynamic variables)	Data format	
Connections	2 or 4 wires, max. distance 1200m, termination directly on the instrument	Baud-rate	
Addresses Protocol	1 to 255, key-pad selectable MODBUS/JBUS		

## Software functions

<b>Password</b>	Numeric code of max. 3 digits; 2 protection levels of the programming data	<b>Displaying</b>	Up to 3 variables per page Page 1: V L1, V L2, V L3 Page 2: V L12, V L23, V L31 Page 3: A L1, A L2, A L3 Page 4: An Page 5: W L1, W L2, W L3 Page 6: PF L1, PF L2, PF L3 Page 7: var L1, var L2, var L3 Page 8: VA L1, VA L2, VA L3 Page 9: VA $\Sigma$ , W $\Sigma$ , var $\Sigma$ Page 10: VA dmd, W dmd, Hz Page 11: Wdmd MAX Page 12: VL-L $\Sigma$ , PF $\Sigma$ Page 13: A MAX
1st level	Password "0", no protection	3-phase system with neutral	
2nd level	Password from 1 to 999, all data are protected		
<b>System selection</b>	3-phase with neutral 3-phase without neutral 3-phase ARON 2-phase Single phase		
<b>Transformer ratio</b>			
CT	1 to 999		
VT	1.0 to 99.9		
<b>Filter</b>		<b>Alarms</b>	
Operating range	0 to 99.9% of the input electrical scale	Programmable, for the VL $\Sigma$ and An (neutral current). Note: the alarm is only visual, by means of LED on the front of the instrument.	
Filtering coefficient	1 to 16		
Filter action	Measurements, alarms, serial output (fundamental variables: V, A, W and their derived ones).	<b>Reset</b>	
		Independent alarm (VL $\Sigma$ , An) max: A, Wdmd	

## Power Supply Specifications

<b>Auxiliary power supply</b>	230VAC -15 +10%, 50-60Hz 115VAC -15 +10%, 50-60Hz 48VAC -15 +10%, 50-60Hz	<b>Power consumption</b>	24VAC -15 +10%, 50-60Hz 18 to 60VDC AC: 4.5 VA DC: 4W
-------------------------------	--	--------------------------	---

## General Specifications

<b>Operating temperature</b>	0 to +50°C (32 to 122°F) (RH < 90% non condensing at 40°C)	RS485.	500VAC/DC between measuring inputs and
<b>Storage temperature</b>	-30 to +60°C (-22 to 140°F) (RH < 90% non condensing at 40°C)		4000VAC, 500VDC between power supply and RS485
<b>Installation category</b>	Cat. III (IEC 60664, EN60664)	<b>Dielectric strength</b>	4000 VAC (for 1 min)
<b>Insulation</b> (for 1 minute)	4000VAC, 500VDC between measuring inputs and power supply.	<b>EMC</b>	
		Emissions	EN50084-1 (class A) residential environment,

## General Specifications (cont.)

Immunity	commerce and light industry EN61000-6-2 (class A) industrial environment.	Dimensions (WxHxD)	96 x 96 x 63 mm
Pulse voltage (1.2/50µs)	EN61000-4-5	Material	ABS self-extinguishing: UL 94 V-0
Safety standards	IEC60664, EN60664	Mounting	Panel
Approvals	CE, UL, CSA	Protection degree	Front: IP65 (standard), NEMA4x, NEMA12 Connections: IP20
Connections 5(6) A Max cable cross sect. area	Screw-type 2.5 mm <sup>2</sup>	Weight	Approx. 400 g (pack. incl.)
Housing			

### Waveform of the signals that can be measured

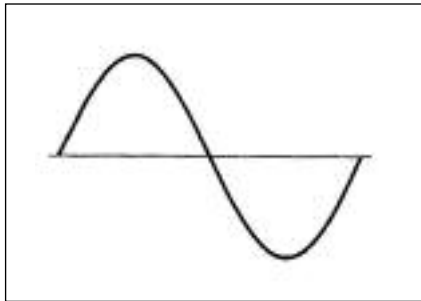

**Figure A**

**Sine wave, undistorted**

Fundamental content	100%
Harmonic content	0%
$A_{rms} =$	1.1107   A

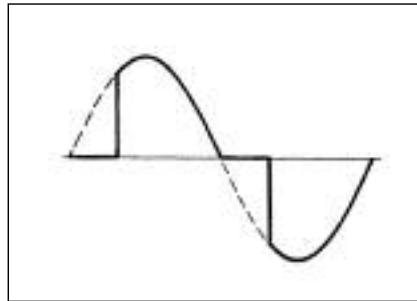

**Figure B**

**Sine wave, indented**

Fundamental content	10...100%
Harmonic content	0...90%
Frequency spectrum:	3rd to 16th harmonic
Additional error:	<1% FS

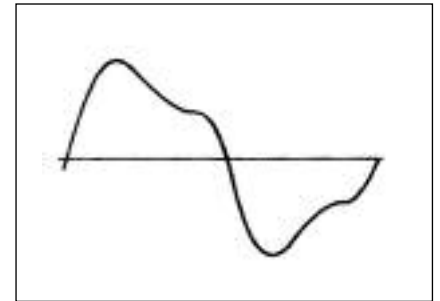

**Figure C**

**Sine wave, distorted**

Fundamental content	70...90%
Harmonic content	10...30%
Frequency spectrum:	3rd to 16th harmonic
Additional error:	<0.5% FS

## Display pages

### Display variables in 3-phase systems (in a 3-phase system with neutral)

No	1 <sup>st</sup> variable	2 <sup>nd</sup> variable	3 <sup>rd</sup> variable	Note
1	V L1	V L2	V L3	
2	V L12	V L23	V L31	Decimal point blinking on the right of the display
3	A L1	A L2	A L3	
4	An	AL.n		AL.n if neutral current alarm is active
5	W L1	W L2	W L3	Decimal point blinking on the right of the display if generated power
6	PF L1	PF L2	PF L3	
7	VAR L1	VAR L2	VAR L3	Decimal point blinking on the right of the display if generated power
8	VA L1	VA L2	VA L3	
9	VA system	W system	VAR system	
10	VA dmd (system)	W dmd (system)	Hz (system)	dmd = demand (integration time selectable from 1 to 30 minutes)
11		W dmd MAX		Maximum sys power demand
12	V LL system	AL.U	PF system	AL.U= is activated only if one of VLN is not within the set limits
13	A MAX			max. current among the three phases

## Used calculation formulas

### Phase variables

Instantaneous effective voltage

$$V_{IN} = \sqrt{\frac{1}{n} \cdot \sum_1^n (V_{INi})^2}$$

Instantaneous active power

$$W_1 = \frac{1}{n} \cdot \sum_1^n (V_{INi}) \cdot (A_1)_i$$

Instantaneous power factor

$$\cos\phi_1 = \frac{W_1}{VA_1}$$

Instantaneous effective current

$$A_1 = \sqrt{\frac{1}{n} \cdot \sum_1^n (A_1)_i^2}$$

Instantaneous apparent power

$$VA_1 = V_{IN} \cdot A_1$$

Instantaneous reactive power

$$VAR_1 = \sqrt{(VA_1)^2 - (W_1)^2}$$

### System variables

Equivalent 3-phase voltage

$$V_{\Sigma} = \frac{V_1 + V_2 + V_3}{3} \cdot \sqrt{3}$$

3-phase reactive power

$$VAR_{\Sigma} = (VAR_1 + VAR_2 + VAR_3)$$

3-phase active power

$$W_{\Sigma} = W_1 + W_2 + W_3$$

3-phase apparent power

$$VA_{\Sigma} = \sqrt{W_{\Sigma}^2 + VAR_{\Sigma}^2}$$

3-phase power factor

$$\cos\phi_{\Sigma} = \frac{W_{\Sigma}}{VA_{\Sigma}}$$

Neutral current

$$An = \bar{A}_{L1} + \bar{A}_{L2} + \bar{A}_{L3}$$

## Wiring diagrams

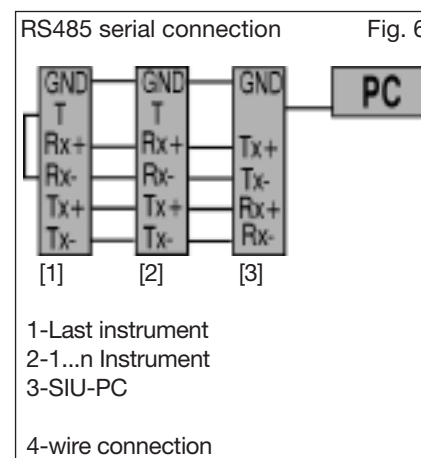
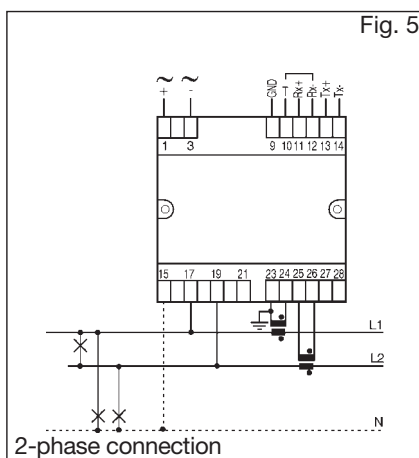
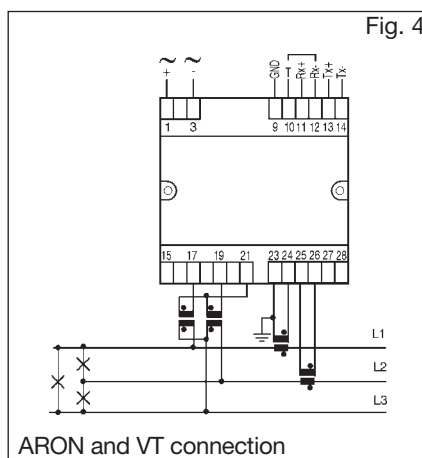
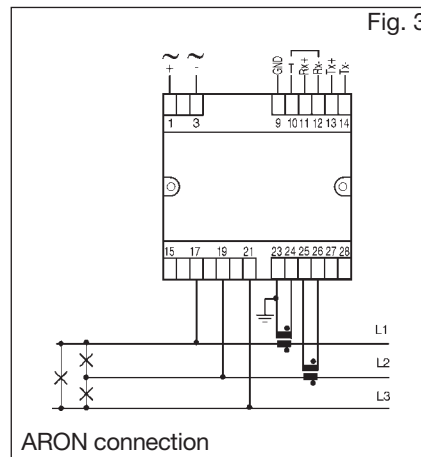
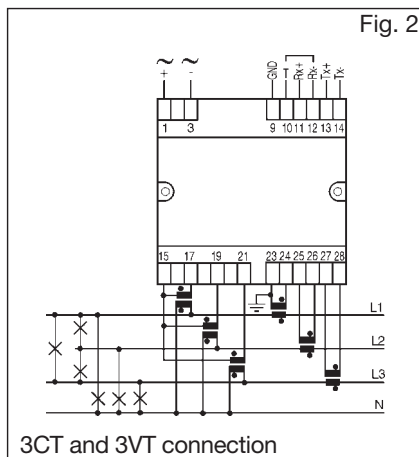
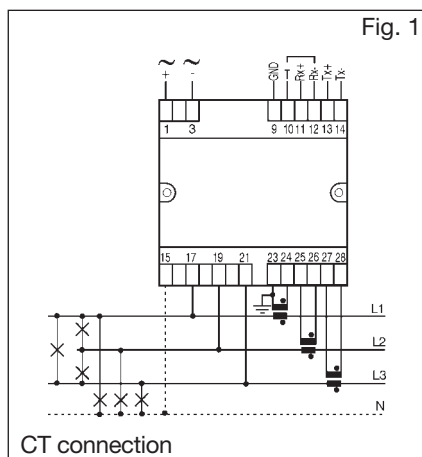

**NOTE:** the current inputs can be connected to the lines **ONLY** by means of current transformers. The direct connection is not allowed.

**ATTENTION:** Only one ammeter input can be connected to earth, as shown in the electrical diagrams.

## Front Panel Description

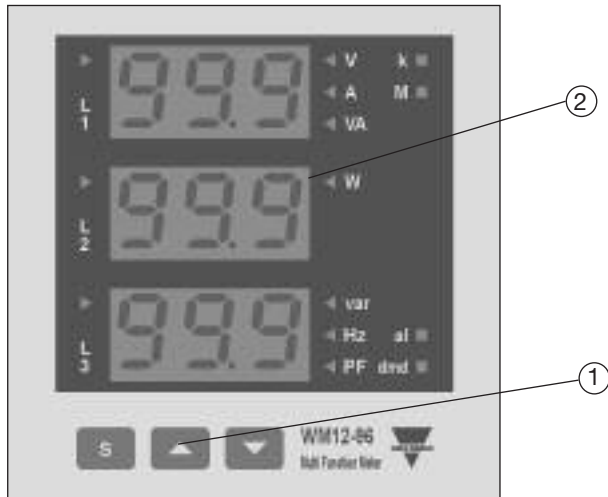

### 1. Key-pad

To program the configuration parameters and the display of the variables.



Key to enter programming and confirm selections;



Keys to:

- programme values;
- select functions;
- display measuring pages.

### 2. Display

LED-type with alphanumeric indications to:

- display configuration parameters;
- display all the measured variables.

## Dimensions and Panel Cut-out

