

Series F18

25-90 Amp • SCR/DIODE Modules

- **Industry Standard Package and Circuits**
- **Power Control Building Blocks**

Modules come in an industry standard package, offering nine circuits that can be used singly or as power control building blocks. All models feature highly efficient thermal management for greatly extended cycle life and are UL recognized (file no. E72445). Manufactured in Crydom's ISO 9001 Certified facility for optimum product performance and reliability.

CRYDOM

Control over power

PART NUMBER IDENTIFICATION

Series Type	Current	Circuit Type	Voltage	Contact Factory
F18-Case style	27 - 25 Amps 42 - 40 Amps 57 - 55 Amps 92 - 90 Amps	(see schematic diagrams) Example: SD	400 - 120 Vac 600 - 240 Vac 1000 - 380 Vac 1200 - 480 Vac 1400 - 530 Vac	For Higher Voltages

Example: F18925D1200

ELECTRICAL SPECIFICATIONS

SYMBOL SPECIFICATION

		27	42	57	92
I_D	Maximum DC Output Current ($T_c = 85^\circ\text{C}$)	25A	40A	55A	90A
V_F	Maximum Voltage Drop @ Amps Peak	1.55V @ 75A	1.4V @ 42A	1.4V @ 165A	1.4V @ 270A
T_J	Operating Junction Temperature Range	-40 $^\circ\text{C}$ to +125 $^\circ\text{C}$			
di/dt	Critical Rate of Rise of On-State Current @ $T_J=125^\circ\text{C}$	100A/ μs	100A/ μs	100A/ μs	100A/ μs
dv/dt	Critical Rate of Rise of Off-State Voltage [V/ μs]	500V/ μs	500V/ μs	500V/ μs	500V/ μs
V_{RRM}	Repetitive Peak Reverse Voltage (AC Line)		400 (120 Vac) 600 (240 Vac) 1000 (380 Vac) 1200 (480 Vac) 1400 (530 Vac)		
I_{TSM}	Maximum Non-Repetitive Surge Current (1/2 Cycle, 60Hz)	400A	1000A	1500A	1950A
I^2T	Maximum I^2T for Fusing ($t=8.3\text{ms}$) [A ^2sec]	670	4150	9350	15800
I_{GT}	Maximum Required Gate Current to Trigger @ 25 $^\circ\text{C}$	150mA	150mA	150mA	150mA
V_{GT}	Maximum Required Gate Voltage to Trigger @ 25 $^\circ\text{C}$	3.0V	3.0V	3.0V	3.0V
$P_{G(AV)}$	Average Gate Power	0.5W	0.5W	0.5W	0.5W
V_{GM}	Maximum Peak Gate Voltage (Reverse)	5.0V	5.0V	5.0V	5.0V
$R_{\theta JC}$	Maximum Thermal Resistance Junction to Ceramic Base per Chip	0.4 $^\circ\text{C}/\text{W}$	0.28 $^\circ\text{C}/\text{W}$	0.25 $^\circ\text{C}/\text{W}$	0.14 $^\circ\text{C}/\text{W}$
V_{ISOL}	Isolation Voltage	2500 V_{RMS}	2500 V_{RMS}	2500 V_{RMS}	2500 V_{RMS}

MECHANICAL SPECIFICATIONS

Weight: (typical)

4.75 oz. (135g)

Torque Required

Terminal Stud Screw : 30 inch lb

Mounting Screw : 20 inch lb

© 2002 CRYDOM CORP Specifications subject to change without notice.

For recommended applications and more information contact:

USA: Sales Support (877) 502-5500 Tech Support (877) 702-7700 FAX (619) 710-8540

Crydom Corp, 2320 Paseo de las Americas, Ste. 201, San Diego, CA 92154

Email: sales@crydom.com WEB SITE: http://www.crydom.com

UK: +44 (0)1202 365070 • FAX +44 (0)1202 365090 Crydom International Ltd., 7 Cobham

Road, Ferndown Industrial Estate, Ferndown, Dorset BH21 7PE, Email: intsales@crydom.com.

GERMANY: +49 (0)180 3000 506



CRYDOM

Control over power

Series F18

25-90 Amp • SCR/DIODE Modules

- Industry Standard Package and Circuits
- Power Control Building Blocks

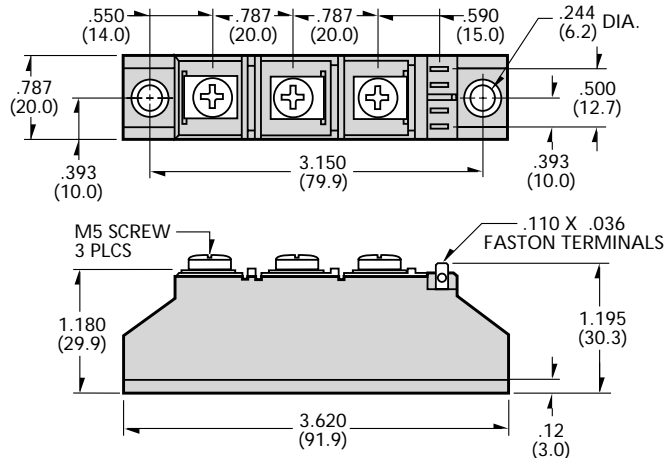

MECHANICAL DIMENSIONS

All dimensions are in inches (millimeters)

PART NUMBER IDENTIFICATION

Series Type
F18-Case style

Current
27 - 25 Amps
42 - 40 Amps
57 - 55 Amps
92 - 90 Amps

Circuit Type
(see schematic diagrams)
Example: SD

Voltage
400 - 120 Vac
600 - 240 Vac
1000 - 380 Vac
1200 - 480 Vac
1400 - 530 Vac

Contact Factory
For Higher Voltages

Example: F18925D1200

SERIES F18 CIRCUITS

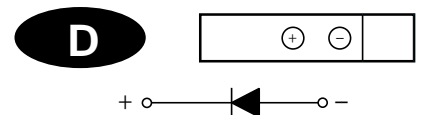
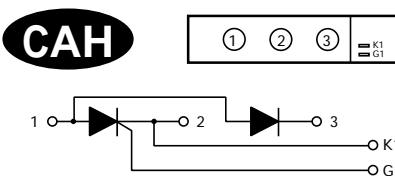
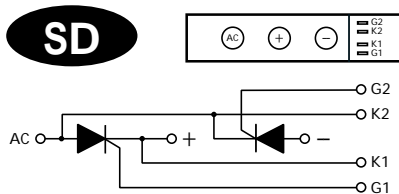
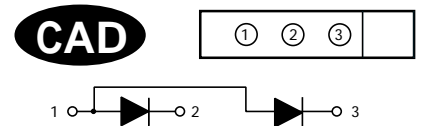
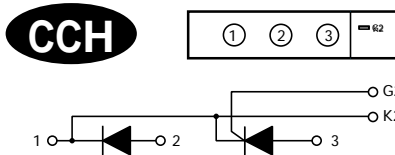
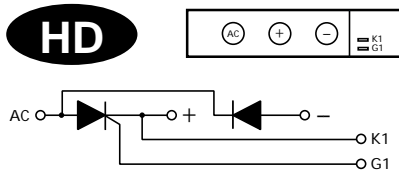
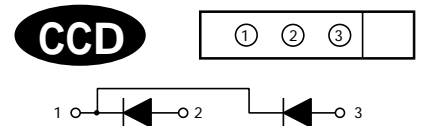
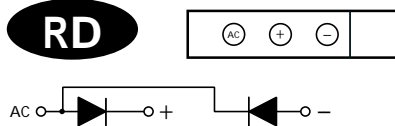
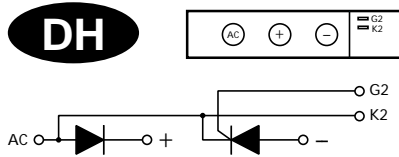

© 2002 CRYDOM CORP Specifications subject to change without notice.

