

N-channel Enhancement-mode Power MOSFET

Dynamic dv/dt rating
 Repetitive Avalanche Rated
 Fast Switching
 Simple Drive Requirement

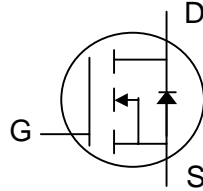

BV_{DSS} 675V
 $R_{DS(ON)}$ 1.2 Ω
 I_D 7A

DESCRIPTION

The SSM07N70C series is specially designed as a main switching device for universal 90~265VAC off-line AC/DC converter applications. Both TO-220 and TO-262 type provide high blocking voltage to overcome voltage surge and sag in the toughest power system with the best combination of fast switching, ruggedized design and cost-effectiveness.

The TO-220 and TO-262 packages are widely preferred for all commercial and industrial applications. The device is well suited for switch-mode power supplies, AC-DC converters and high-current high-speed switching circuits.

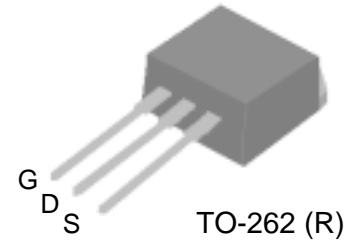
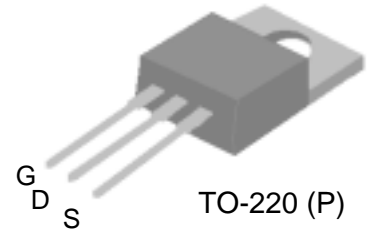

ABSOLUTE MAXIMUM RATINGS

Symbol	Parameter	Rating	Units
V_{DS}	Drain-Source Voltage	675	V
V_{GS}	Gate-Source Voltage	± 30	V
$I_D @ T_C=25^\circ\text{C}$	Continuous Drain Current, $V_{GS} @ 10\text{V}$	7	A
$I_D @ T_C=100^\circ\text{C}$	Continuous Drain Current, $V_{GS} @ 10\text{V}$	4.4	A
I_{DM}	Pulsed Drain Current ¹	18	A
$P_D @ T_C=25^\circ\text{C}$	Total Power Dissipation	89	W
	Linear Derating Factor	0.7	W/ $^\circ\text{C}$
E_{AS}	Single Pulse Avalanche Energy ²	140	mJ
I_{AR}	Avalanche Current	7	A
E_{AR}	Repetitive Avalanche Energy	7	mJ
T_{STG}	Storage Temperature Range	-55 to 150	$^\circ\text{C}$
T_J	Operating Junction Temperature Range	-55 to 150	$^\circ\text{C}$

THERMAL DATA

Symbol	Parameter	Value	Unit
Rthj-c	Thermal Resistance Junction-case	Max. 1.4	$^\circ\text{C}/\text{W}$
Rthj-a	Thermal Resistance Junction-ambient	Max. 62	$^\circ\text{C}/\text{W}$

Electrical Characteristics @T_j=25°C(unless otherwise specified)

Symbol	Parameter	Test Conditions	Min.	Typ.	Max.	Units
BV _{DSS}	Drain-Source Breakdown Voltage	V _{GS} =0V, I _D =1mA	675	-	-	V
ΔBV _{DSS} /ΔT _j	Breakdown Voltage Temperature Coefficient	Reference to 25°C, I _D =1mA	-	0.6	-	V/°C
R _{DS(ON)}	Static Drain-Source On-Resistance	V _{GS} =10V, I _D =3.5A	-	-	1.2	Ω
V _{GS(th)}	Gate Threshold Voltage	V _{DS} =V _{GS} , I _D =250uA	2	-	4	V
g _{fs}	Forward Transconductance	V _{DS} =10V, I _D =3.5A	-	4.5	-	S
I _{DSS}	Drain-Source Leakage Current (T _j =25°C)	V _{DS} =675V, V _{GS} =0V	-	-	10	uA
	Drain-Source Leakage Current (T _j =150°C)	V _{DS} =480V, V _{GS} =0V	-	-	100	uA
I _{GSS}	Gate-Source Leakage	V _{GS} = ± 30V	-	-	±100	nA
Q _g	Total Gate Charge ³	I _D =7A	-	32	-	nC
Q _{gs}	Gate-Source Charge	V _{DS} =480V	-	8.6	-	nC
Q _{gd}	Gate-Drain ("Miller") Charge	V _{GS} =10V	-	9	-	nC
t _{d(on)}	Turn-on Delay Time ³	V _{DD} =300V	-	17	-	ns
t _r	Rise Time	I _D =7A	-	15	-	ns
t _{d(off)}	Turn-off Delay Time	R _G =10Ω, V _{GS} =10V	-	35	-	ns
t _f	Fall Time	R _D =43Ω	-	18	-	ns
C _{iss}	Input Capacitance	V _{GS} =0V	-	2075	-	pF
C _{oss}	Output Capacitance	V _{DS} =25V	-	120	-	pF
C _{rss}	Reverse Transfer Capacitance	f=1.0MHz	-	8	-	pF

Source-Drain Diode

Symbol	Parameter	Test Conditions	Min.	Typ.	Max.	Units
I _S	Continuous Source Current (Body Diode)	V _D =V _G =0V , V _S =1.5V	-	-	7	A
I _{SM}	Pulsed Source Current (Body Diode) ¹		-	-	18	A
V _{SD}	Forward On Voltage ³	T _j =25°C, I _S =7A, V _{GS} =0V	-	-	1.5	V

Notes:

- 1.Pulse width limited by safe operating area.
- 2.Starting T_j=25°C , V_{DD}=50V , L=5mH , R_G=25Ω , I_{AS}=7A.
- 3.Pulse width ≤300us , duty cycle ≤2%.

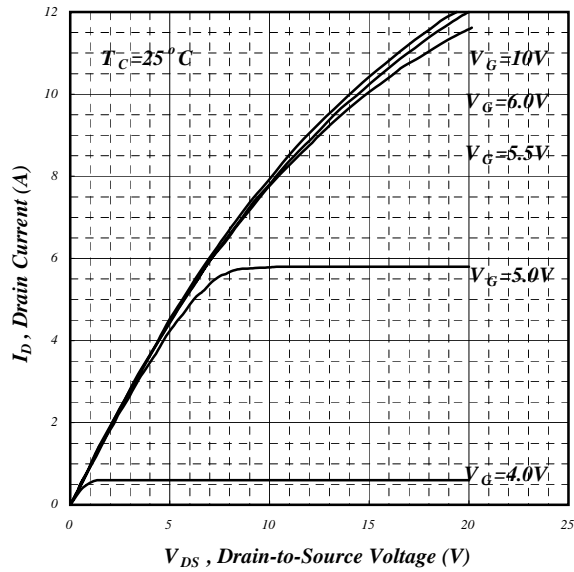

Fig 1. Typical Output Characteristics

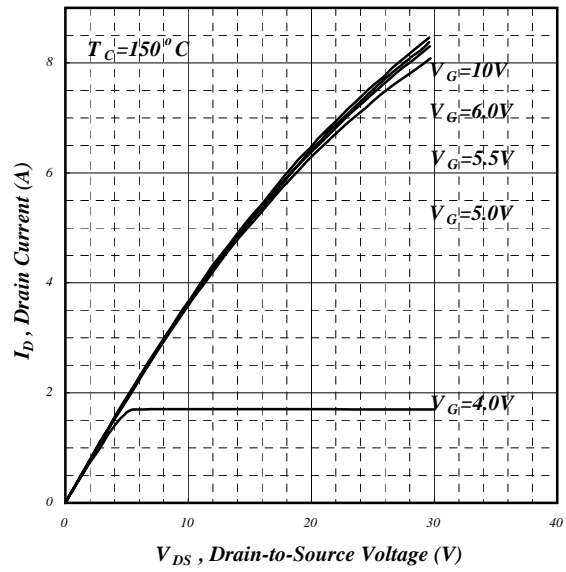

Fig 2. Typical Output Characteristics

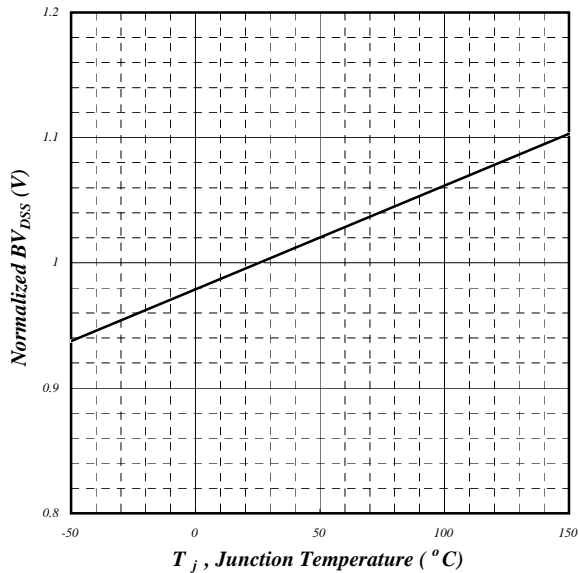

Fig 3. Normalized BV_{DSS} vs. Junction Temperature

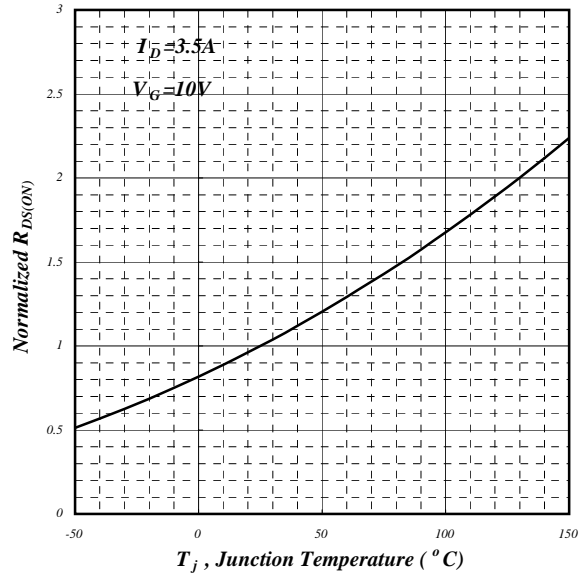

Fig 4. Normalized On-Resistance vs. Junction Temperature

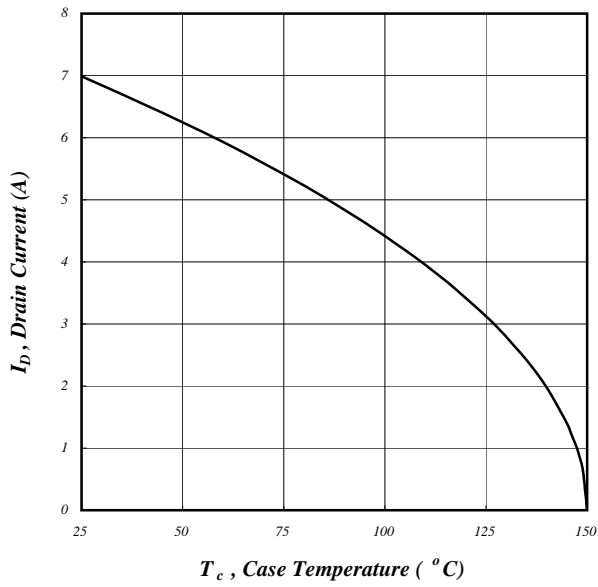

Fig 5. Maximum Drain Current vs. Case Temperature

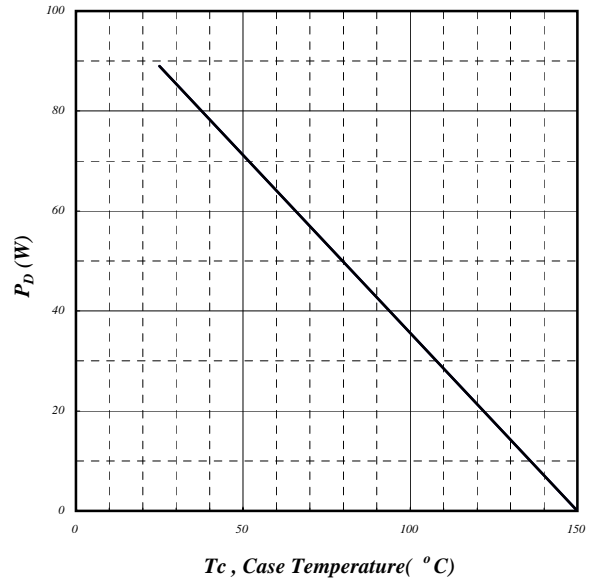

Fig 6. Typical Power Dissipation

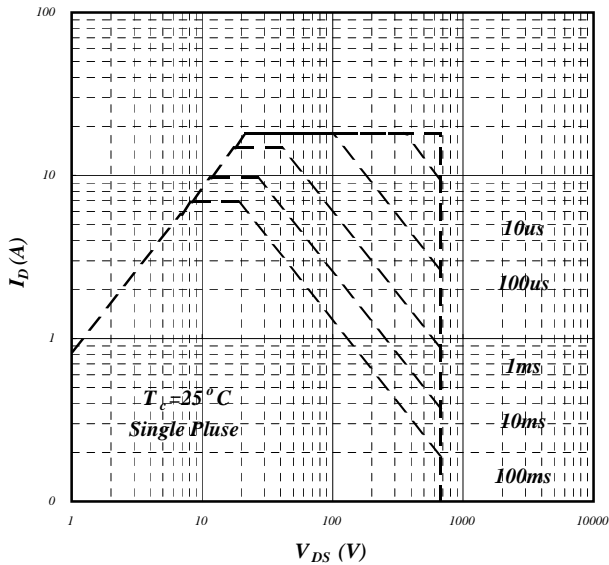

Fig 7. Maximum Safe Operating Area

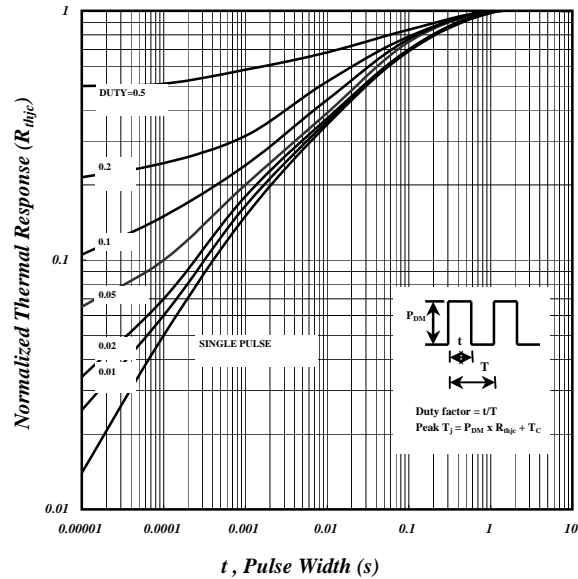

Fig 8. Effective Transient Thermal Impedance

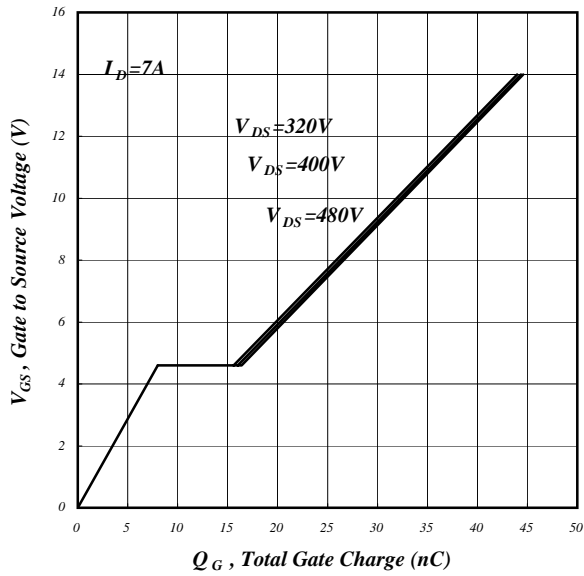

Fig 9. Gate Charge Characteristics

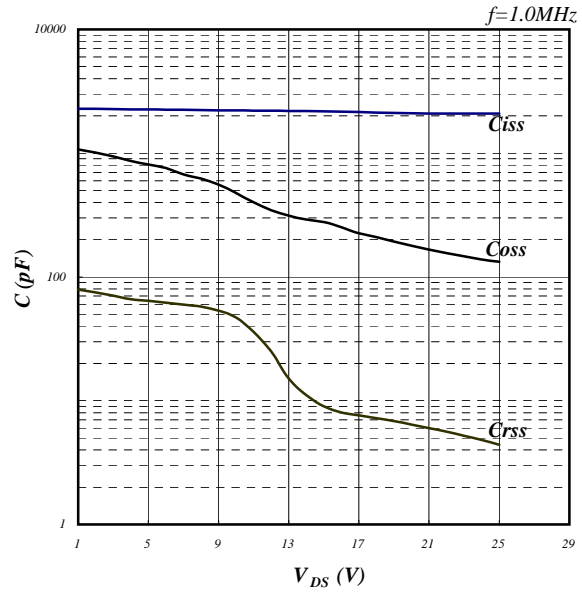

Fig 10. Typical Capacitance Characteristics

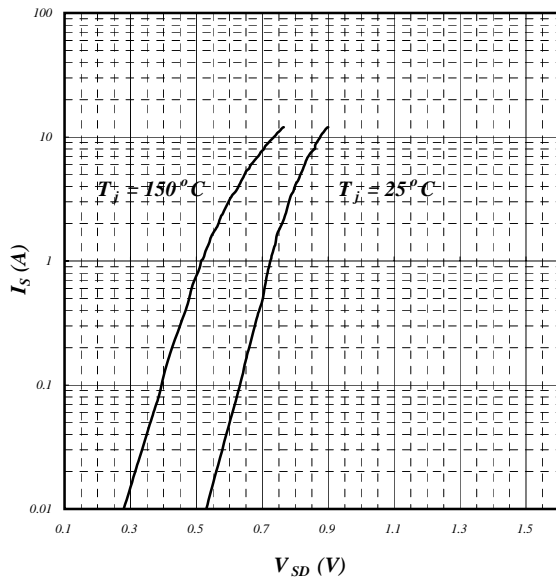

Fig 11. Forward Characteristic of Reverse Diode

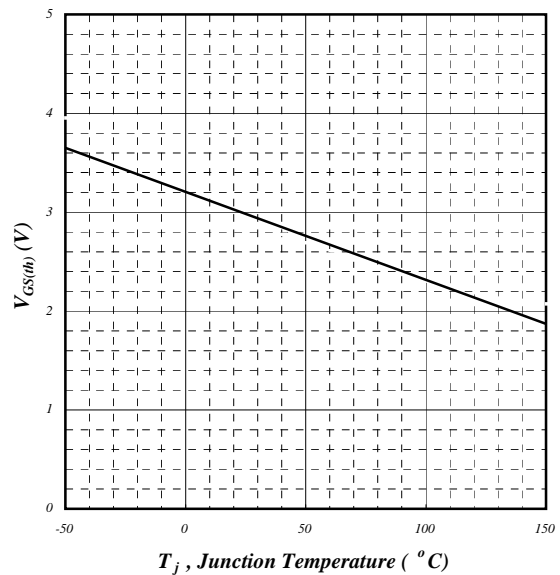

Fig 12. Gate Threshold Voltage vs. Junction Temperature

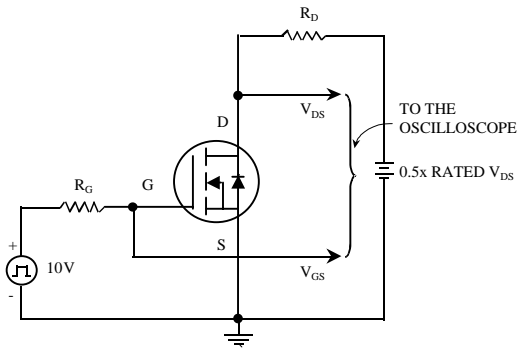

Fig 13. Switching Time Circuit

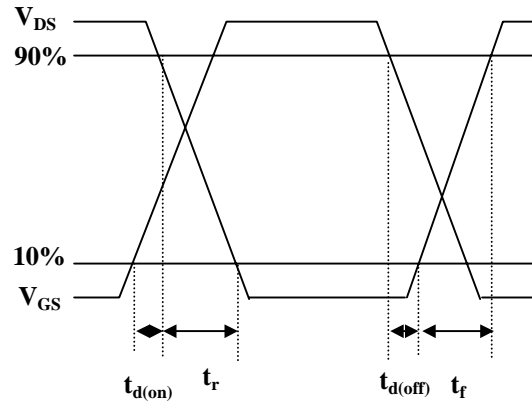

Fig 14. Switching Time Waveform

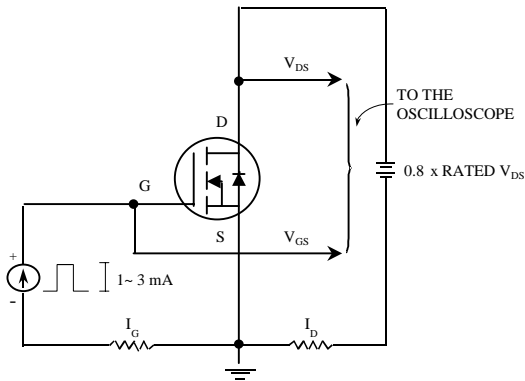

Fig 15. Gate Charge Circuit

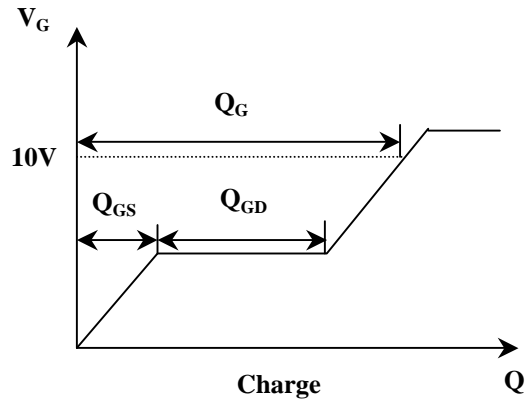

Fig 16. Gate Charge Waveform

Information furnished by Silicon Standard Corporation is believed to be accurate and reliable. However, Silicon Standard Corporation makes no guarantee or warranty, express or implied, as to the reliability, accuracy, timeliness or completeness of such information and assumes no responsibility for its use, or for infringement of any patent or other intellectual property rights of third parties that may result from its use. Silicon Standard reserves the right to make changes as it deems necessary to any products described herein for any reason, including without limitation enhancement in reliability, functionality or design. No license is granted, whether expressly or by implication, in relation to the use of any products described herein or to the use of any information provided herein, under any patent or other intellectual property rights of Silicon Standard Corporation or any third parties.