

LAN-PAC SERIES

DC/DC CONVERTERS—9V OUTPUT

FEATURES

- IEEE 802.3 standards
- Meets FCC Sec 15, Sub Part J, A&B
- Input/Output isolated to IEEE 802.3 standards
- PC mountable, low profile
- Continuous short circuit protected, self recovering (2E12R9, 2E12R9E and 2E5R9)
- No derating to 71°C
- Wide input voltage range
- 100% burned-in and triple tested
- 3 year warranty

GENERAL DESCRIPTION

The Lan-Pac Series of DC/DC converters is designed to provide power and isolation for local area network (LAN) transceiver chips.

The Lan-Pac Series covers both the Cheapernet and Ethernet LAN (IEEE 802.3 10base 5 and 10base 2 standards) approach. The use of a compact and inexpensive DC/DC converter as the power source for these new transceiver chips allows conversion of the normal buss power to the isolated power required.

The series operates from inputs of 5 and 12 VDC for Cheapernet with input/output isolation of 500 VDC and wide input models of 10.2 - 15.75 VDC for Ethernet, with 2500 VDC isolation.

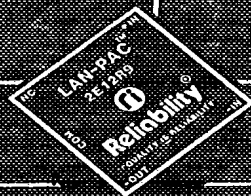

GENERAL ELECTRICAL SPECIFICATIONS

(Specifications at Nominal Input and 25°C)

| PARAMETER | LIMIT | CONDITIONS |
|---------------------------------------|--|--|
| 2VP, 2VI, 2SP & 2PC Series | | |
| Input Voltage Range | 4.75 - 5.25VDC 11.4 - 12.6VDC | 5V Devices 12V Devices |
| Input Filter | Filter Capacitor | All Device Types |
| Input/Output Isolation Voltage | 500 VDC (Min.) 3000 VDC (Min.) | All 2VP, 2VI & 2SP Device Types 2PC5R9 Only |
| Resistance | 10 ³ megohms (Min.) | |
| Output Voltage Accuracy | ± 5% | Nom. Line at Full Load (2VP, 2VI & 2SP Device Types) Overline, Load (2PC5R9) |
| Load Regulation | See Graph* | |
| Output Noise/Ripple | 100 mV, P-P (Max.) | 20 HZ-20MHZ Bandwidth |
| Minimum Load Required | 10% of Full Load | All Units Except 2PC5R9 |
| Line Regulation | See Graph* | |
| Short Circuit Protection | Momentary | All Units |
| Operating Temperature | -25° to 71°C | |
| Derating | None | To 71°C |
| Storage Temperature | -55°C to + 125°C | |
| FCC Sec 15, Sub Part J | Yes | Class B Radiated, Class A Conducted |
| 2E Series | | |
| Input Voltage Range | 10.2 - 15.75 | All Devices |
| Input Filter | Filter Capacitor | All Devices |
| Input/Output Isolation Voltage | 2500 VDC (Min.) | All Device Types |
| Resistance | 10 ³ megohms (Min.) | |
| Output Voltage Accuracy | ± 5% | Nom. Line at Full Load |
| Load Regulation | 50 mV | Nom. Line, NL to FL |
| Line Regulation | 300 mV | Full input range, FL |
| Output Noise/Ripple | 100 mV, P-P (Max.) | 20 HZ-20MHZ Bandwidth |
| Short Circuit Protection | Current Fold-Back | All Units |
| Duration | Continuous | |
| Switching Frequency | 30 KHZ | Typical |
| Operating Temperature | -25° to + 71°C | |
| Derating | None | To 71°C |
| Storage Temperature | -55°C to + 125°C | |
| External Heatsink | Recommended for still air environments | |
| Case | UL94V-0 | |
| Encapsulant | UL94H-B | |
| Heat Dissipation | 45°C Case Rise | High Line, Full Load |
| FCC Sec 15, Sub Part J | Yes | Class B Radiated, Class A Conducted |

SELECTION GUIDE STANDARD PRODUCTS

| DEVICE TYPE | INPUT VOLTAGE VDC | INPUT CURRENT A (MAX) | OUTPUT VOLTAGE VDC | OUTPUT CURRENT ma (MAX) | PACKAGE | APPLICATION |
|-------------|-------------------|-----------------------|--------------------|-------------------------|---------|-------------|
| 2VP5U9 | 5 | .600 | -9 | 250 | 2VP | Cheapernet |
| 2VI5U9 | 5 | .600 | -9 | 250 | 2VI | Cheapernet |
| 2PC5R9 | 5 | .550 | -9 | 200 | 2PC | Cheapernet |
| 2SP5U9 | 5 | .600 | -9 | 250 | 2SP | Cheapernet |
| 2VP5U9LN | 5 | .550 | -9 | 250 | 2VP | Cheapernet |
| 2E5R9 | 5 | .900 | -9 | 250 | 2E | Ethernet |
| 2VP12U9 | 12 | .250 | -9 | 250 | 2VP | Cheapernet |
| 2E12R9 | 12 | .350 | -9 | 250 | 2E | Ethernet |
| 2E12R9E | 12 | .400 | -9 | 250 | 2E | Ethernet |
| 2SP12U9 | 12 | .250 | -9 | 250 | 2SP | Cheapernet |

MECHANICAL DIMENSIONS AND PIN CONNECTIONS

2E

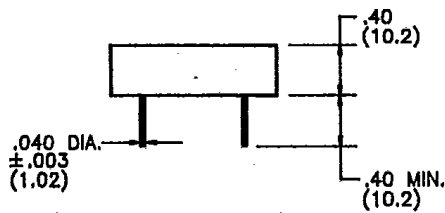

2E5R9 & 2E12R9

| PIN | PIN CONNECTIONS |
|-----|-----------------|
| 1 | + INPUT |
| 2 | - INPUT |
| 3 | NO CONNECTION |
| 4 | OUTPUT COMMON |
| 5 | - OUTPUT |

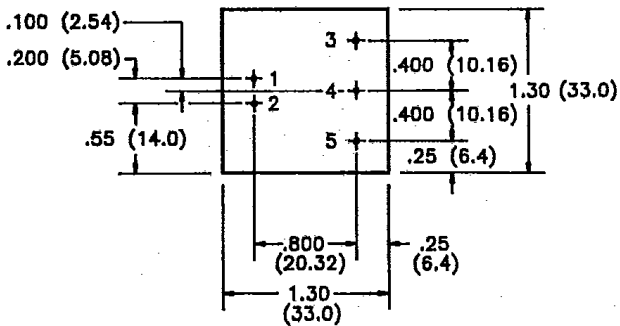

2E12R9E

| PIN | PIN CONNECTIONS |
|-----|-----------------|
| 1 | + INPUT |
| 2 | - INPUT |
| 3 | + INPUT |
| 4 | ENABLE INPUT |
| 5 | INPUT COMMON |

Note: All dimensions in parentheses are mm.
Tolerances unless otherwise specified: .XX ± .03
.XXX ± .010

2V

TOP

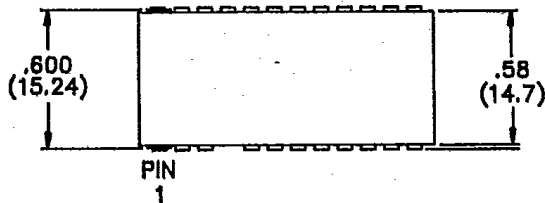

SIDE

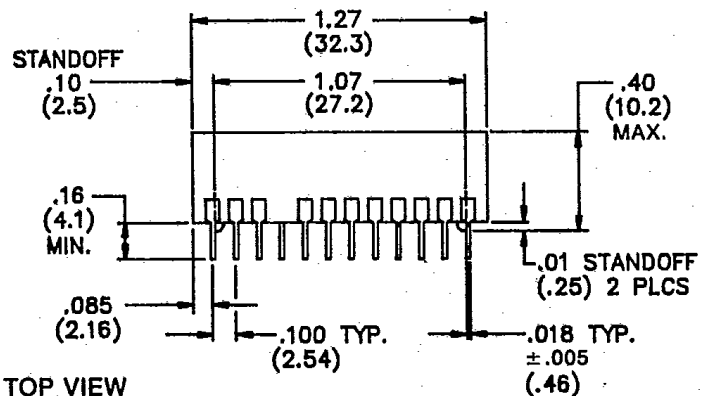

TOP VIEW
2VP SERIES

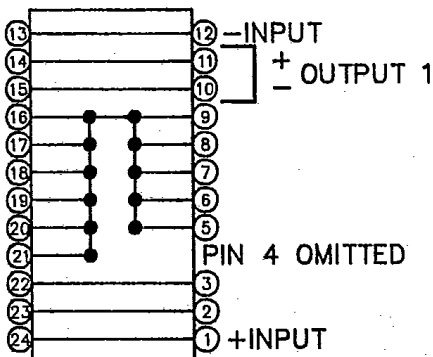

TOP VIEW
2VI5U9

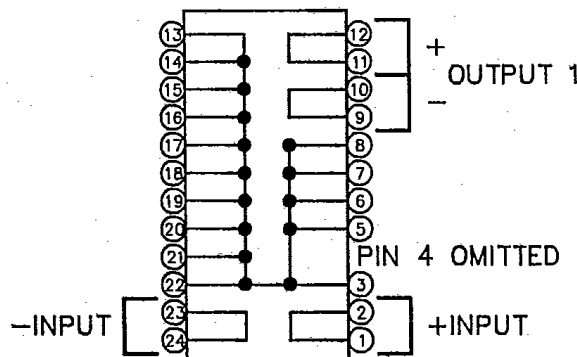

MECHANICAL DIMENSIONS AND PIN CONNECTIONS

2PC

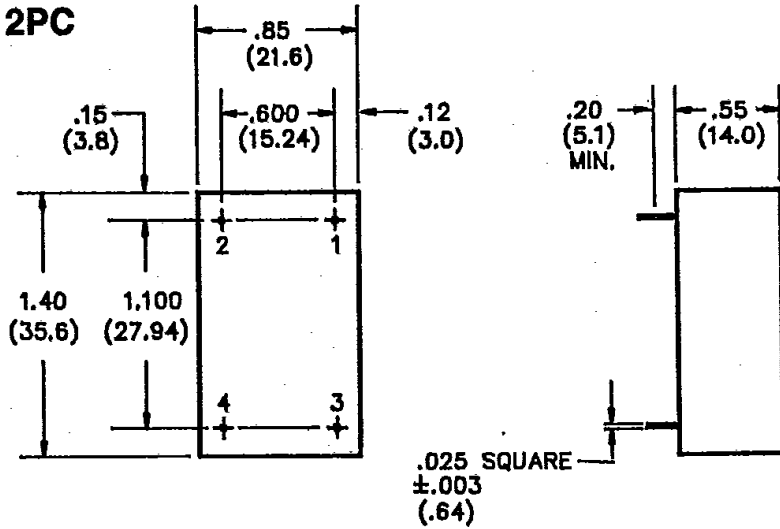

| PIN | PIN CONNECTIONS |
|-----|-----------------|
| 1 | + INPUT |
| 2 | - INPUT |
| 3 | + OUTPUT |
| 4 | - OUTPUT |

SP

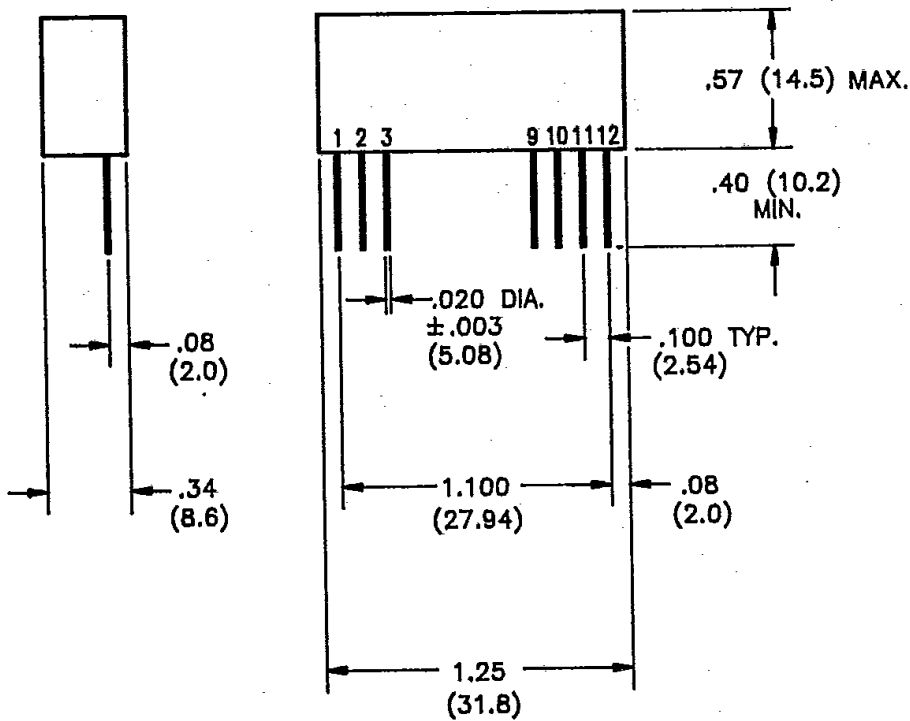

| PIN | SINGLE OUTPUT |
|-----|---------------|
| 1 | + INPUT |
| 2 | NC |
| 3 | NC |
| 9 | NC |
| 10 | - OUTPUT |
| 11 | + OUTPUT |
| 12 | - INPUT |

Note: All dimensions in parentheses are mm.

Tolerances unless otherwise specified: .XX ± .03

.XXX ± .010

PERFORMANCE DATA 2VP5U9 & 2VI5U9

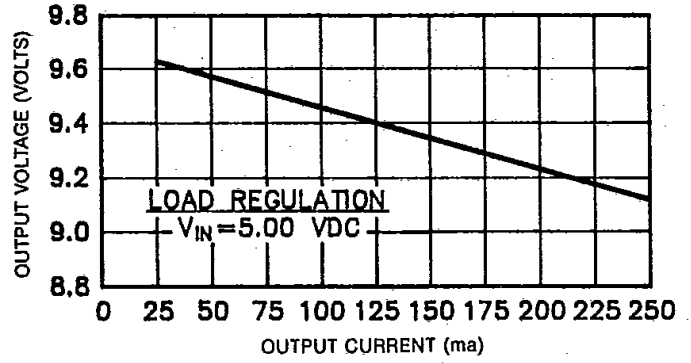
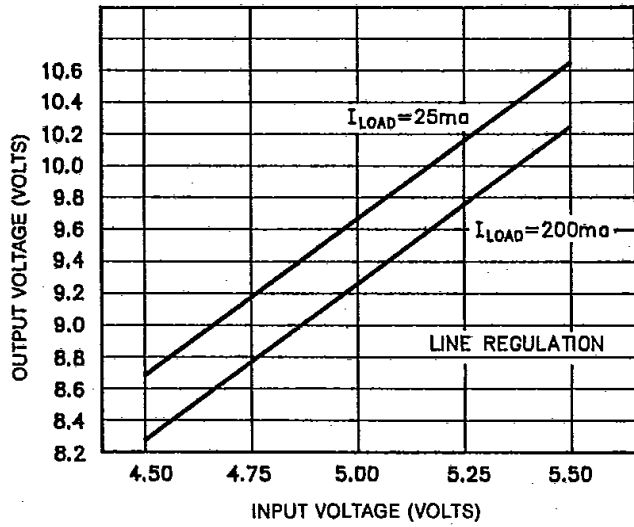

PERFORMANCE DATA 2VP12U9

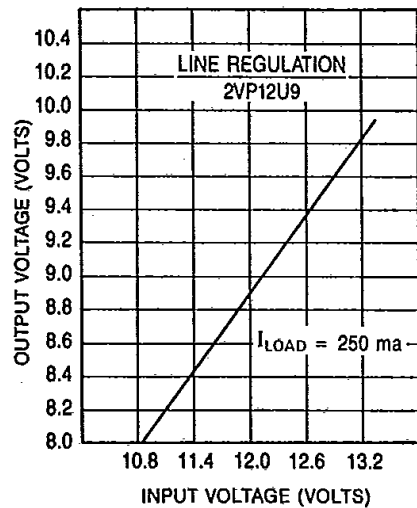
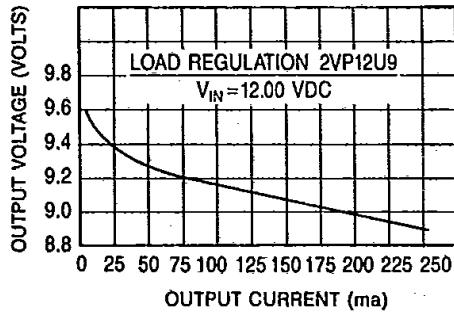

2E12R9

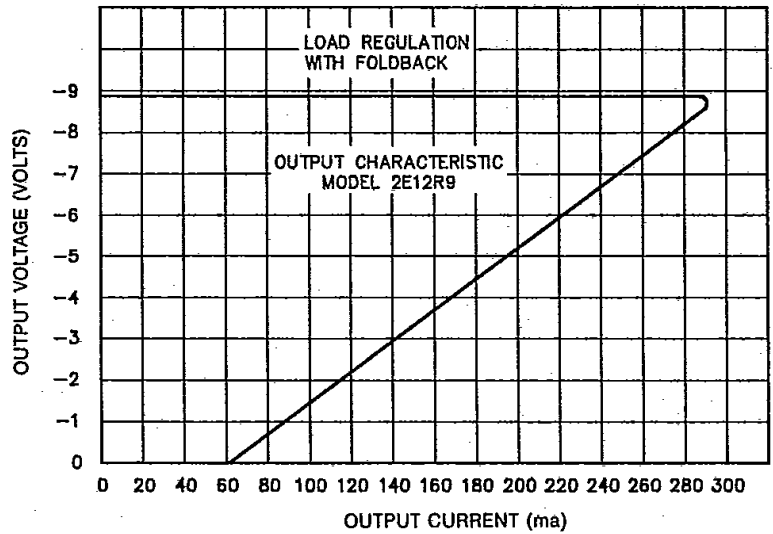

APPLICATIONS

The Reliability family of Lan-Pac converters is designed to provide the isolated power requirements for transceiver integrated circuits used in either Ethernet or Cheapernet Local Area Networks.

For Ethernet applications, IEEE 802.3 specifies a power connection cable not more than 50 meters long with the Vc (voltage common) line capable of sinking 2 amps. Also, the DC power pair shall be composed of a twisted pair of sufficient gauge stranded wires to result in a nominal DC resistance not to exceed 1.75 ohms per conductor. Furthermore, IEEE 802.3 requires that the local power supply be capable of operating at one fixed level (VP) between + 12 VDC - 6% and + 15VDC + 5% with respect to circuit Vc for all current values from 0 to 500 ma.

From the above, we can see that the minimum input voltage to the Lan-Pac Converter is:

$$12 - (12 \times 0.06) - (3.5 \text{ ohms}) (\text{Input current}) \text{ or } 11.28 - 3.5 I_{in} = V_{min}$$

similarly, the maximum input voltage is:

$$15 + (15 \times 0.05) - (3.5 \text{ ohms}) (\text{Input current}) \text{ or } 15.75 - 3.5 I_{in} = V_{max}$$

with a total power cable resistance of 3.5 ohms.

Obviously, with no input current or zero cable resistance the maximum input voltage to the Ethernet DC/DC converters is 15.75 and is so specified in the General Electrical Specifications. However, as regards minimum input voltage, all Ethernet converters are guaranteed to meet their specifications with a local power supply voltage of 11.28V and source impedance of 3.5 ohms, while the converter is operating at maximum output current.

