

PLASTIC-CASE JUNCTION FIELD-EFFECT TRANSISTORS

N-Channel JFETs

ELECTRICAL CHARACTERISTICS at $T_A = 25^\circ\text{C}$

Device Type	$V_{(BR)GSS}$		I_{GSS}		$V_{GS(EM)}$				I_{DSS}			θ_{IS}			C_{ISS}^1		C_{RSS}^1		r_{DS} Max. (Ω)	Process
					Limits		Conditions													
	Min. (V)	(αI_G) (μA)	Max. (nA)	(αV_{GS}) (V)	Min. (V)	Max. (V)	V_{DS} (V)	I_D (nA)	Min. (mA)	Max. (mA)	(αV_{DS}) (V)	Min. (mS)	Max. (mS)	(αV_{DS}) (V)	Max. (pF)	(αV_{DS}) (V)	Max. (pF)	(αV_{DS}) (V)		
TP5951	-30	-1.0	-1.0	-15	-2.0	-5.0	15	100	7.0	13	15	3.0	—	15	6.0	15	2.0	15	—	NJ32
TP5952	-30	-1.0	-1.0	-15	-1.3	-3.5	—	100	4.0	8.0	15	1.0	—	15	6.0	15	2.0	15	—	NJ32
TP5953	-30	-1.0	-1.0	-15	-0.8	-3.0	15	100	2.5	5.0	15	1.0	—	15	6.0	15	2.0	15	—	NJ42
TP6449	-300	-10	100	-150	-2.0	-15	30	4.0	2.0	10	30	0.5	3.0	30	10	30	5.0	30	—	NJ42
TP6450	-200	-10	100	-100	-2.0	-15	30	4.0	2.0	10	30	0.5	3.0	30	10	30	5.0	30	—	NJ42
TP6451	-20	-1.0	-1.0	-10	-0.5	-3.5	10	1.0	5.0	20	10	—	—	—	25	10	5.0	10	—	NJ132L
TP6452	-25	-1.0	-1.0	-15	-0.5	-3.5	10	1.0	5.0	20	10	—	—	—	25	10	5.0	10	—	NJ132L
TP6453	-20	-1.0	-1.0	-10	-0.75	-5.0	10	1.0	15	50	10	—	—	—	25	10	5.0	10	—	NJ132L
TP6454	-25	-1.0	-1.0	-15	-0.75	-5.0	10	1.0	15	50	10	—	—	—	25	10	5.0	10	—	NJ132L
BF244A	-30	-1.0	-5	-20	-0.5	-8.0	15	10	2.0	6.5	15	3.0	6.5	15	—	—	—	—	—	NJ26
BF244B	-30	-1.0	-5	-20	-0.5	-8.0	15	10	6.0	15	15	3.0	6.5	15	—	—	—	—	—	NJ26
BF244C	-30	-1.0	-5	-20	-0.5	-8.0	15	10	12	25	15	3.0	6.5	15	—	—	—	—	65	NJ132
BF246A	-25	-1.0	-5	-15	-0.6	-14.5	15	10	30	80	15	—	—	—	—	—	—	—	50	NJ132
BF246B	-25	-1.0	-5	-15	-0.6	-14.5	15	10	60	140	15	—	—	—	—	—	—	—	35	NJ132
BF246C	-25	-1.0	-5	-15	-0.6	-14.5	15	10	110	250	15	—	—	—	—	—	—	—	—	NJ132
BF256A	-30	-1.0	-5	-20	-0.5	-7.5	15	10	3.0	7.0	15	4.5	—	15	4.5	15	1.2	15	—	NJ26
BF256B	-30	-1.0	-5	-20	-0.5	-7.5	15	10	6.0	13	15	4.5	—	15	4.5	15	1.2	15	—	NJ26
BF256C	-30	-1.0	-5	-20	-0.5	-7.5	15	10	11	18	15	4.5	—	15	4.5	15	1.2	15	—	NJ26
BFR30	-25	-1.0	-0.2	-10	—	-5.0	10	0.5	4.0	10	10	1.0	4.0	10 ⁶	5.0	10 ⁶	1.5	10 ⁶	—	NJ26
BFR31	-25	-1.0	-0.2	-10	—	-2.5	10	0.5	1.0	5.0	10	1.5	4.5	10 ⁶	5.0	10 ⁶	1.5	10 ⁶	—	NJ26
J111	-35	-1.0	-1.0	-15	-3.0	-10	5.0	1.0 ²	20	—	15	—	—	—	16	15	5	—	30	NJ132
J111A	-40	-1.0	-0.2	-15	-5.0	-10	5.0	1.0 ²	30	—	15	—	—	—	16	15	5	—	30	NJ132
J112	-35	-1.0	-1.0	-15	-1.0	-5.0	5.0	1.0 ²	5.0	—	15	—	—	—	16	15	5	—	50	NJ99
J112A	-40	-1.0	-0.2	-15	-2.0	-7.0	5.0	1.0 ²	15	—	15	—	—	—	16	15	5	—	50	NJ99
J113	-35	-1.0	-1.0	-15	—	-3.0	5.0	1.0 ²	2.0	—	15	—	—	—	16	15	5	—	100	NJ99
J113A	-40	-1.0	-0.2	-15	-1.0	-5.0	5.0	1.0 ²	8.0	—	15	—	—	—	16	15	5	—	80	NJ99
J201	-40	-1.0	-0.1	-20	-0.3	-1.5	20	10	0.2	1.0	20	0.5	—	20	4.0	20	1.0	20	—	NJ16
J202	-40	-1.0	-0.1	-20	-0.8	-4.0	20	10	0.9	4.5	20	1.0	—	20	4.0	20	1.0	20	—	NJ16
J203	-40	-1.0	-0.1	-20	-2.0	-10	20	10	4.0	20	20	1.5	—	20	6.0	20	1.2	20	—	NJ32
J210	-25	-1.0	-0.1	-15	-1.0	-3.0	15	1.0	2.0	15	15	4.0	12	15	—	—	—	—	—	NJ26L
J211	-25	-1.0	-0.1	-15	-2.5	-4.5	15	1.0	7.0	20	15	6.0	12	15	—	—	—	—	—	NJ26L
J212	-25	-1.0	-0.1	-15	-4.0	-6.0	15	1.0	15	40	15	7.0	12	15	—	—	—	—	—	NJ26L
J230	-40	-1.0	-0.2	-30	-0.5	-3.0	20	1.0 ²	0.7	3.0	20	1.0	3.5	20	—	—	—	—	—	NJ16
J231	-40	-1.0	-0.2	-30	-1.5	-5.0	20	1.0 ²	2.0	6.0	20	1.5	4.0	20	—	—	—	—	—	NJ16
J232	-40	-1.0	-0.2	-30	-3.0	-6.0	20	1.0 ²	5.0	10	20	2.5	5.0	20	—	—	—	—	—	NJ16
J300A	-25	-1.0	-0.5	-15	-1.5	-3.0	10	1.0	4.0	9.0	10	4.5	9.0	10 ⁵	5.5	10 ⁵	1.7	10 ⁵	—	NJ26L
J300B	-25	-1.0	-0.5	-15	-2.0	-4.0	10	1.0	7.0	15	10	4.5	9.0	10 ⁵	5.5	10 ⁵	1.7	10 ⁵	—	NJ26L
J300C	-25	-1.0	-0.5	-15	-2.5	-5.0	10	1.0	12	25	10	4.5	9.0	10 ⁵	5.5	10 ⁵	1.7	10 ⁵	—	NJ26L
J304	-30	-1.0	-0.1	-20	-2.0	-6.0	15	1.0	5.0	15	15	4.5	7.5	15	—	—	—	—	—	NJ26
J305	-30	-1.0	-0.1	-20	-0.5	-3.0	15	1.0	1.0	8.0	15	3.0	—	15	—	—	—	—	—	NJ26
MPF102	-25	-1.0	-2.0	-15	—	-8.0	15	2.0	2.0	20	15	2.0	7.5	15	7.0	15	3.0	15	—	NJ26
MPF103	-25	-1.0	-1.0	-15	—	-6.0	15	1.0	1.0	5.0	15	1.0	5.0	15	7.0	15	3.0	15	—	NJ32
MPF104	-25	-1.0	-1.0	-15	—	-7.0	15	1.0	2.0	9.0	15	1.5	5.5	15	7.0	15	3.0	15	—	NJ32
MPF105	-25	-1.0	-1.0	-15	—	-8.0	15	1.0	4.0	16	15	2.0	6.0	15	7.0	15	3.0	15	—	NJ26
MPF106	-25	-1.0	-1.0	-20	-0.5	-4.0	15	0.5	4.0	10	15	2.5	—	15	5.0	15	2.0	15	—	NJ26
MPF107	-25	-1.0	-1.0	-20	-2.0	-6.0	15	0.5	8.0	20	15	4.0	—	15	5.0	15	1.2	15	—	NJ26
MPF108	-25	-1.0	-1.0	-15	-0.5	-8.0	15	10 ²	1.5	24	15	2.0	7.5	15	6.5	15	2.5	15	—	NJ26
MPF109	-25	-1.0	-1.0	-15	-0.2	-8.0	15	10 ²	0.5	24	15	0.8	6.0	15	7.0	15	3.0	15	—	NJ32

- NOTES:
 1) $V_{GS} = 0$ V.
 2) I_D in μA .
 3) $V_{DS} = 0$ V, V_{GS} in volts.
 4) $I_D = 10$ mA.
 5) $I_D = 5.0$ mA.
 6) $I_D = 1.0$ mA.
 7) $I_D = 500$ μA .
 8) $I_D = 200$ μA .

PACKAGE INFORMATION

TO-226AA/STYLES CG AND CO

DIMENSIONS IN INCHES

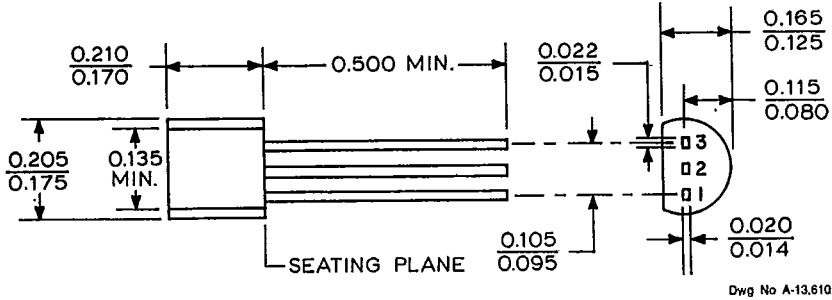

Dwg No A-13.610

DIMENSIONS IN MILLIMETERS

Based on 1" = 25.4 mm

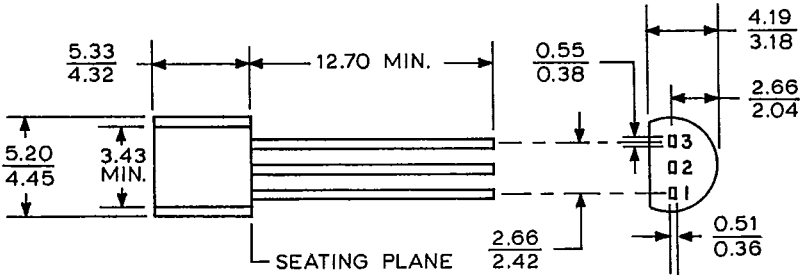

Dwg. No. A-13.611

MAXIMUM ALLOWABLE PACKAGE POWER DISSIPATION AS A FUNCTION OF AMBIENT TEMPERATURE

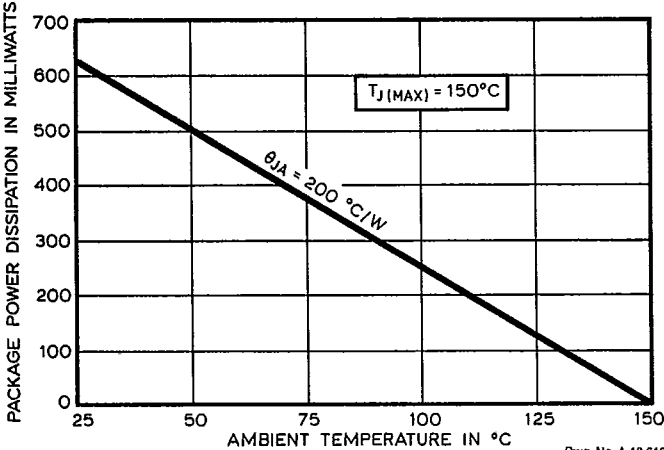

Dwg No A-13.612



CG PINOUT

Pin	Terminal
1	Drain
2	Source
3	Gate

CO PINOUT

Pin	Terminal
1	Source
2	Drain
3	Gate

PACKAGE INFORMATION

TO-226AA/STYLES CI AND CN

DIMENSIONS IN INCHES

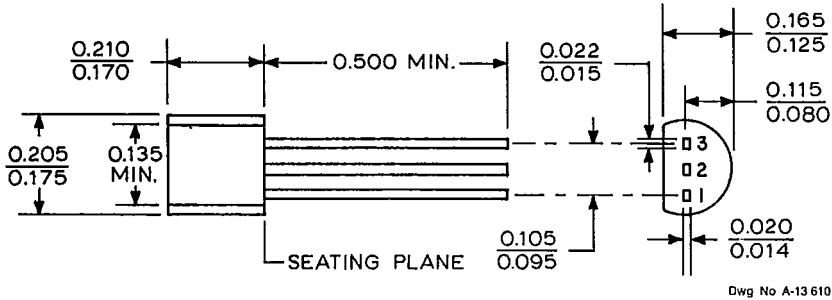

Dwg No A-13610

DIMENSIONS IN MILLIMETERS

Based on 1" = 25.4 mm

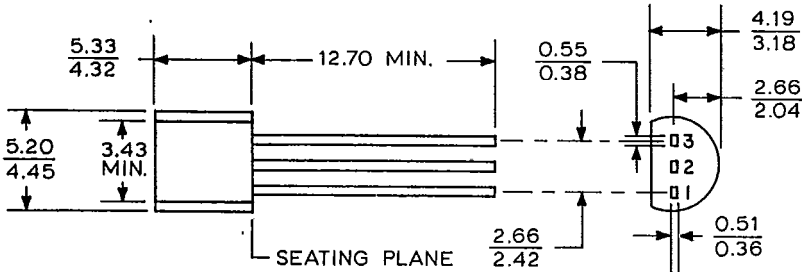

Dwg No A-13611

MAXIMUM ALLOWABLE PACKAGE POWER DISSIPATION AS A FUNCTION OF AMBIENT TEMPERATURE

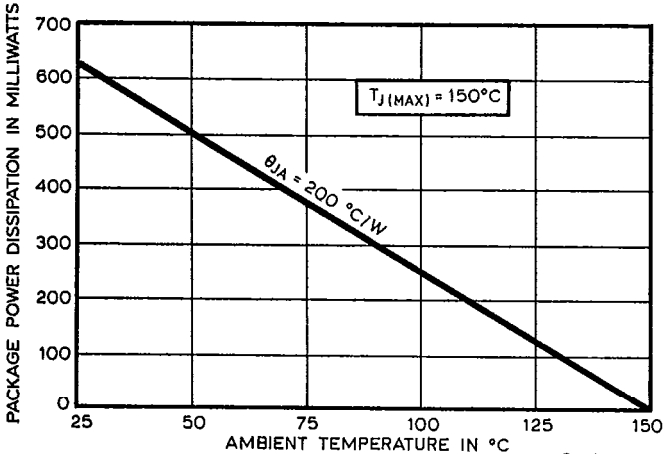

Dwg No A-13612



CI PINOUT

Pin	Terminal
1	Drain
2	Gate
3	Source

CN PINOUT

Pin	Terminal
1	Source
2	Gate
3	Drain

PACKAGE INFORMATION

TO-226AA/STYLES CJ AND CY

DIMENSIONS IN INCHES

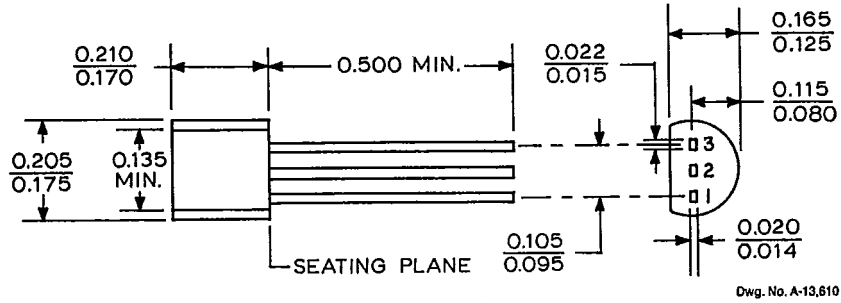

DIMENSIONS IN MILLIMETERS

Based on 1" = 25.4 mm

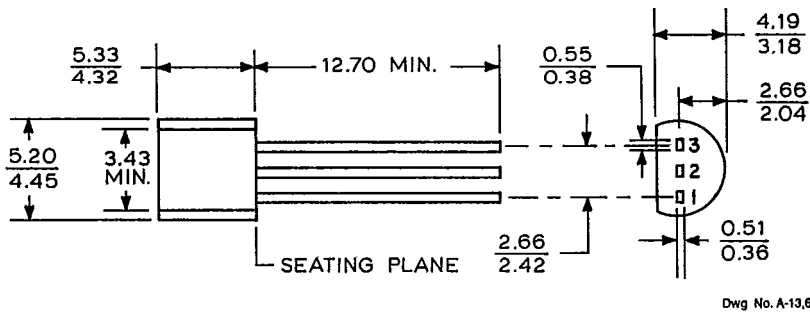

MAXIMUM ALLOWABLE PACKAGE POWER DISSIPATION AS A FUNCTION OF AMBIENT TEMPERATURE

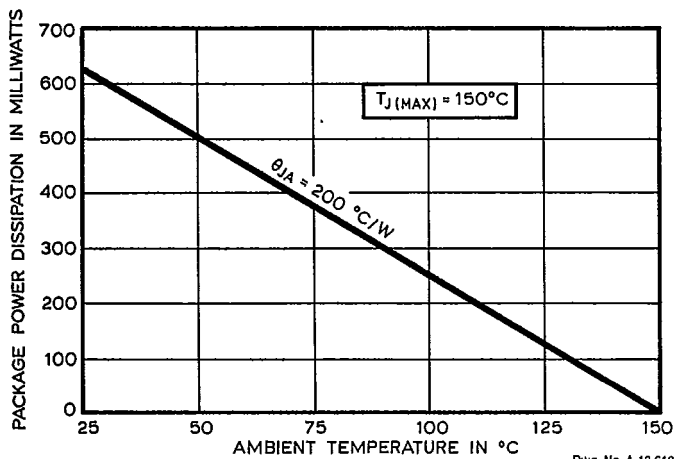

CJ PINOUT

Pin	Terminal
1	Gate
2	Source
3	Drain

CY PINOUT

Pin	Terminal
1	Gate
2	Drain
3	Source