

### Technical Data

NTH / NCH Series

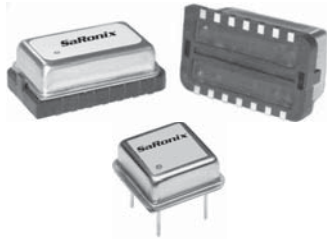

#### Description

A crystal controlled, low current, low jitter and high frequency oscillator with precise rise and fall times demanded in networking applications. The tri-state function on the NTH enables the output to go high impedance. Device is packaged in a 14 or an 8-pin DIP compatible resistance welded, all metal grounded case to reduce EMI. True SMD DIL14 versions for IR reflow are available, select option "S" in part number builder. See separate data sheet for SMD package dimensions.

#### Applications & Features

- ADSL, DSL
- DS3, ES3, E1, STS-1, T1
- Ethernet Switch, Gigabit Ethernet
- Fibre Channel Controller
- MPEG
- Network Processors
- Voice Over Packet
- 32 Bit Microprocessors
- Tri-State output on NTH
- LVCMOS / HCMOS compatible
- Available up to 106.25 MHz

#### Output Waveform

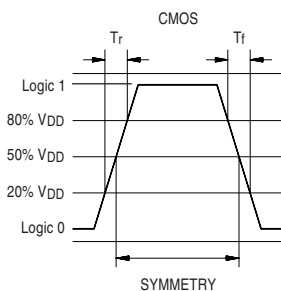

<b>Frequency Range:</b>	0.5 MHz to 106.25 MHz																		
<b>Frequency Stability:</b>	±20, ±25, ±50 or ±100 ppm over all conditions: calibration tolerance, operating temperature, input voltage change, load change, 30 day aging, shock and vibration.																		
<b>Temperature Range:</b>	Operating: 0 to +70°C or -40 to +85°C, See Part Numbering Guide Storage: -55 to +125°C																		
<b>Supply Voltage:</b>	Recommended Operating: 3.3V ±10%																		
<b>Supply Current:</b>	20mA max, 0.5 to 30 MHz 25mA max, 30+ to 50 MHz 30mA max, 50+ to 80 MHz 35mA max, 80+ to 106.25 MHz																		
<b>Output Drive:</b>	<table border="0"> <tr> <td><b>HCMOS</b></td> <td>Symmetry:</td> <td>45/55% max 0.5 to 70 MHz max 40/60% max @ 50% VDD</td> </tr> <tr> <td></td> <td>Rise and Fall Times:</td> <td>4ns max 0.5 to 50 MHz, 20% to 80% VDD 3ns max 50+ to 80 MHz 1.5ns max 80+ to 106.25 MHz</td> </tr> <tr> <td></td> <td>Logic 0:</td> <td>10% VDD max</td> </tr> <tr> <td></td> <td>Logic 1:</td> <td>90% VDD min</td> </tr> <tr> <td></td> <td>Load:</td> <td>50pF, 0.5 to 50 MHz 30pF, 50+ to 70 MHz 15pF, 70+ to 106.25 MHz</td> </tr> <tr> <td></td> <td>Period Jitter RMS:</td> <td>8ps max</td> </tr> </table>	<b>HCMOS</b>	Symmetry:	45/55% max 0.5 to 70 MHz max 40/60% max @ 50% VDD		Rise and Fall Times:	4ns max 0.5 to 50 MHz, 20% to 80% VDD 3ns max 50+ to 80 MHz 1.5ns max 80+ to 106.25 MHz		Logic 0:	10% VDD max		Logic 1:	90% VDD min		Load:	50pF, 0.5 to 50 MHz 30pF, 50+ to 70 MHz 15pF, 70+ to 106.25 MHz		Period Jitter RMS:	8ps max
<b>HCMOS</b>	Symmetry:	45/55% max 0.5 to 70 MHz max 40/60% max @ 50% VDD																	
	Rise and Fall Times:	4ns max 0.5 to 50 MHz, 20% to 80% VDD 3ns max 50+ to 80 MHz 1.5ns max 80+ to 106.25 MHz																	
	Logic 0:	10% VDD max																	
	Logic 1:	90% VDD min																	
	Load:	50pF, 0.5 to 50 MHz 30pF, 50+ to 70 MHz 15pF, 70+ to 106.25 MHz																	
	Period Jitter RMS:	8ps max																	
<b>Mechanical:</b>	<table border="0"> <tr> <td>Shock:</td> <td>MIL-STD-883, Method 2002, Condition B</td> </tr> <tr> <td>Solderability:</td> <td>MIL-STD-883, Method 2003</td> </tr> <tr> <td>Terminal Strength:</td> <td>MIL-STD-883, Method 2004, Conditions A &amp; C</td> </tr> <tr> <td>Vibration:</td> <td>MIL-STD-883, Method 2007, Condition A</td> </tr> <tr> <td>Solvent Resistance:</td> <td>MIL-STD-202, Method 215</td> </tr> <tr> <td>Resistance to Soldering Heat:</td> <td>MIL-STD-202, Method 210, Condition A, B or C</td> </tr> </table>	Shock:	MIL-STD-883, Method 2002, Condition B	Solderability:	MIL-STD-883, Method 2003	Terminal Strength:	MIL-STD-883, Method 2004, Conditions A & C	Vibration:	MIL-STD-883, Method 2007, Condition A	Solvent Resistance:	MIL-STD-202, Method 215	Resistance to Soldering Heat:	MIL-STD-202, Method 210, Condition A, B or C						
Shock:	MIL-STD-883, Method 2002, Condition B																		
Solderability:	MIL-STD-883, Method 2003																		
Terminal Strength:	MIL-STD-883, Method 2004, Conditions A & C																		
Vibration:	MIL-STD-883, Method 2007, Condition A																		
Solvent Resistance:	MIL-STD-202, Method 215																		
Resistance to Soldering Heat:	MIL-STD-202, Method 210, Condition A, B or C																		
<b>Environmental:</b>	<table border="0"> <tr> <td>Gross Leak Test:</td> <td>MIL-STD-883, Method 1014, Condition C</td> </tr> <tr> <td>Fine Leak Test:</td> <td>MIL-STD-883, Method 1014, Condition A2</td> </tr> <tr> <td>Thermal Shock:</td> <td>MIL-STD-883, Method 1011, Condition A</td> </tr> <tr> <td>Moisture Resistance:</td> <td>MIL-STD-883, Method 1004</td> </tr> </table>	Gross Leak Test:	MIL-STD-883, Method 1014, Condition C	Fine Leak Test:	MIL-STD-883, Method 1014, Condition A2	Thermal Shock:	MIL-STD-883, Method 1011, Condition A	Moisture Resistance:	MIL-STD-883, Method 1004										
Gross Leak Test:	MIL-STD-883, Method 1014, Condition C																		
Fine Leak Test:	MIL-STD-883, Method 1014, Condition A2																		
Thermal Shock:	MIL-STD-883, Method 1011, Condition A																		
Moisture Resistance:	MIL-STD-883, Method 1004																		

### Technical Data

### NTH / NCH Series

#### Package Details

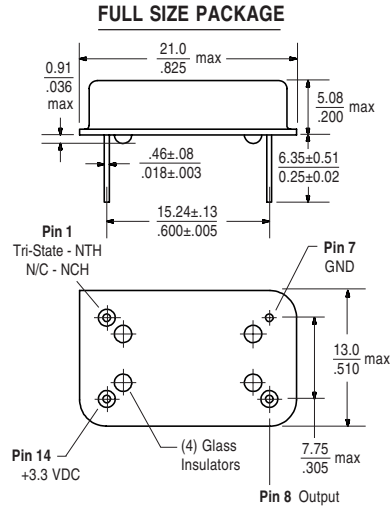

#### Standard Marking Format\*\*

Includes Date Code, Frequency & Part Number

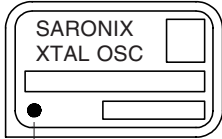

#### HALF SIZE PACKAGE

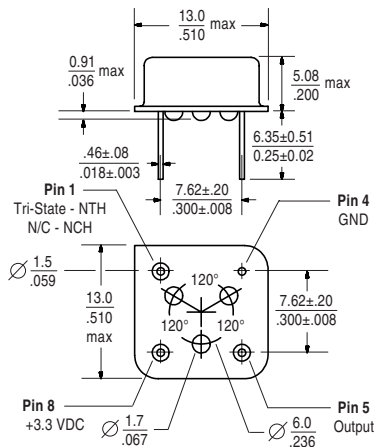

#### Standard Marking Format\*\*

Includes Date Code, Frequency & Part Number



\*\*Exact location of items may vary

#### Part Numbering Guide

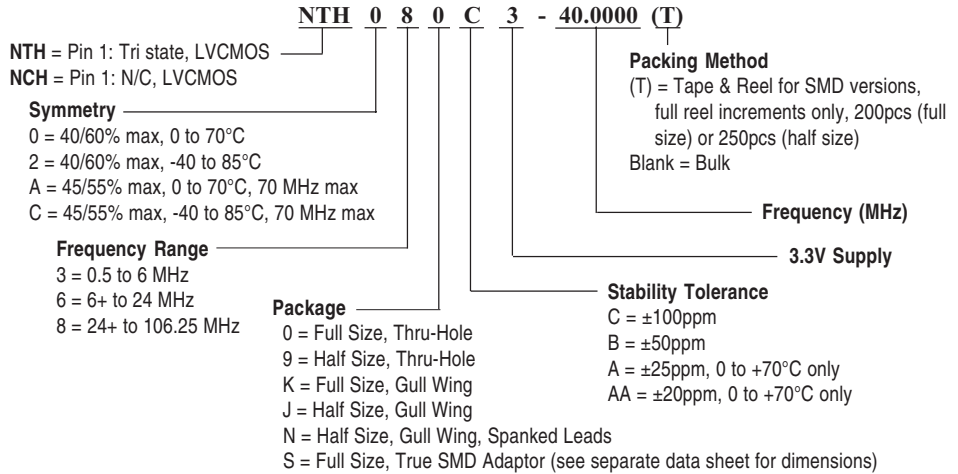

#### Tri-State Logic Table (NTH only)

Pin 1 Input	Pin 8 (5) Output
Logic 1 or NC	Oscillation
Logic 0 or GND	High Impedance

Required Input Levels on Pin 1:  
Logic 1 = 2.2V min  
Logic 0 = 0.8V max

Output: Oscillation @  $V_{IN}$ , 2.2V min  
Output: High Impedance @  $V_{IN}$ , 0.8V max  
Internal Pullup Resistance: 50K $\Omega$  min  
Control Input: Disable Output Delay: 100ns max

#### Test Circuit

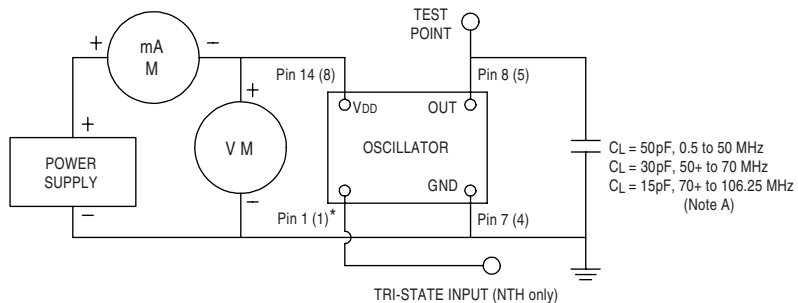

NOTE A:  $C_L$  includes probe and fixture capacitance  
\*( ) Indicates pin numbers for half-size package

All specifications are subject to change without notice.

DS-159 REV D

## True SMD Adaptor - 7.57mm High

### Technical Data

