

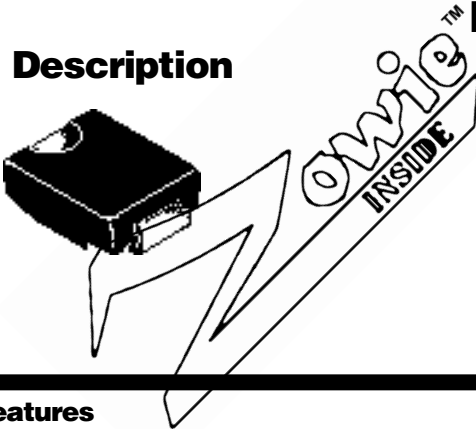

# 3.0 Amp Glass Passivated Sintered Fast Efficient Rectifiers

EGFZ30A . . . 30M Series

## Description



## Mechanical Dimensions

Package "SMC"

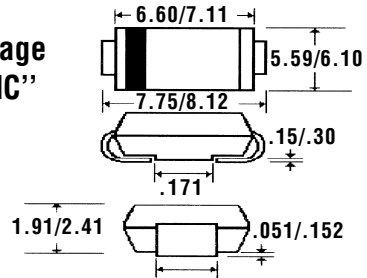

## Features

- **LOWEST COST FOR GLASS SINTERED FAST EFFICIENT CONSTRUCTION**
- **LOWEST  $V_F$  FOR GLASS SINTERED FAST EFFICIENT CONSTRUCTION**
- **TYPICAL  $I_r < 100$  nAmps**
- **3.0 AMP OPERATION @  $T_A = 55^\circ\text{C}$ , WITH NO THERMAL RUNAWAY**
- **SINTERED GLASS CAVITY-FREE JUNCTION**

Electrical Characteristics @ 25°C.	EGFZ30A . . . 30M Series								Units
Maximum Ratings	30A	30B	30D	30G	30J	30K	30M		
Peak Repetitive Reverse Voltage... $V_{RRM}$	50	100	200	400	600	800	1000	Volts	
RMS Reverse Voltage... $V_{R(rms)}$	35	70	140	280	420	560	700	Volts	
DC Blocking Voltage... $V_{DC}$	50	100	200	400	600	800	1000	Volts	
Average Forward Rectified Current... $I_{F(av)}$ Current 3/8" Lead Length @ $T_A = 55^\circ\text{C}$				3.0				Amps	
Non-Repetitive Peak Forward Surge Current... $I_{FSM}$ 8.3mS, 1/2 Sine Wave Superimposed on Rated Load				125				Amps	
Forward Voltage @ 3.0A... $V_F$	< ..... 1.0 ..... >		1.3	< ..... 1.7 ..... >				Volts	
DC Reverse Current... $I_{R(max)}$ @ Rated DC Blocking Voltage				5.0				$\mu\text{Amps}$	
				100					
Typical Junction Capacitance... $C_j$ (Note 1)				60				pF	
Typical Thermal Resistance... $R_{\theta JA}$ (Note 2)				15				$^\circ\text{C/W}$	
Maximum Reverse Recovery Time... $t_{RR}$ (Note 3)	< ..... 50 ..... >		< ..... 75 ..... >					nS	
Operating & Storage Temperature Range... $T_J, T_{STRG}$	-65 to 150							$^\circ\text{C}$	



# 3.0 Amp Glass Passivated Sintered Fast Efficient Rectifiers

**EGFZ30A . . . 30M Series**

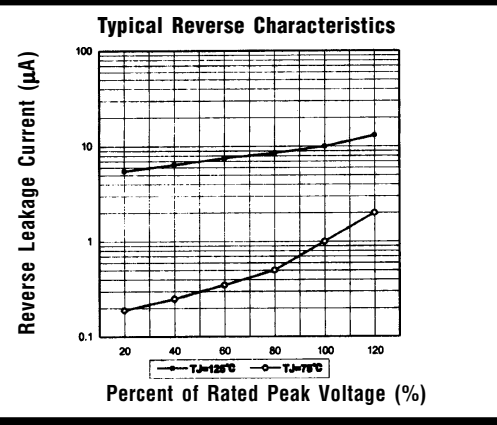
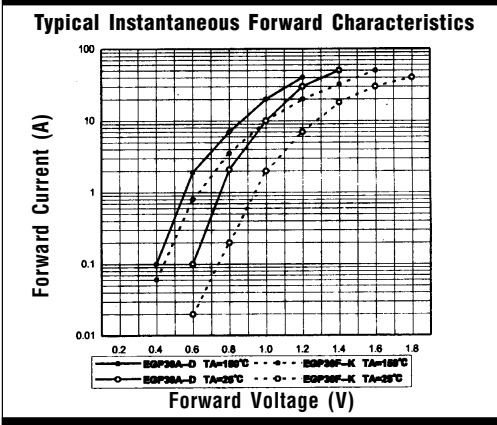
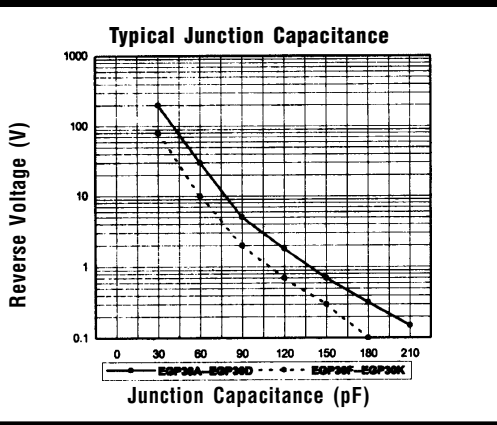
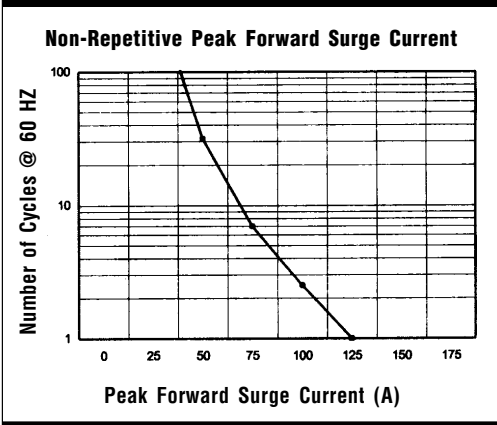
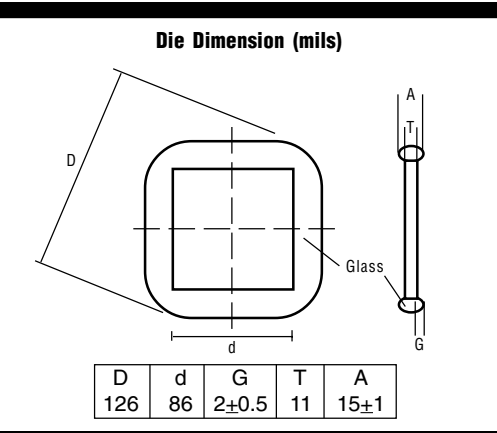
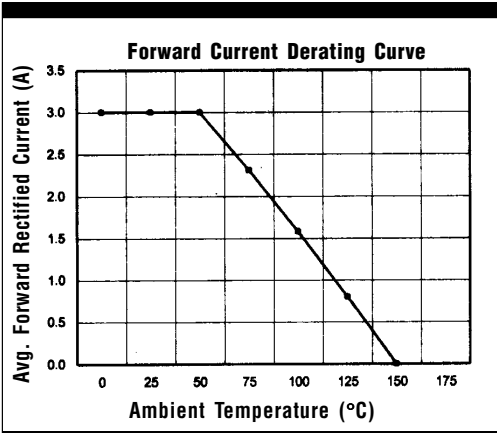

Ratings at 25 Deg. C ambient temperature unless otherwise specified.

Single Phase Half Wave, 60 HZ Resistive or Inductive Load.

For Capacitive Load, Derate Current by 20%.

- NOTES:**
1. Measured @ 1 MHz and applied reverse voltage of 4.0V.
  2. Thermal Resistance from Junction to Ambient at 3/8" Lead Length, P.C. Board Mounted.
  3. Reverse Recovery Condition  $I_F = 0.5A$ ,  $I_R = 1.0A$ ,  $I_{RR} = 0.25A$ .