

2.4GHz DPDT GaAs Single-Band WLAN Switch

Features:

- ◆ Available as RF known good die
- ◆ Suitable for Single-band WLAN 802.11b/g Applications
- ◆ Excellent low control voltage performance
- ◆ Very low Insertion loss typ. 0.55dB at 2.4GHz
- ◆ High isolation typ. 23dB at 2.4GHz

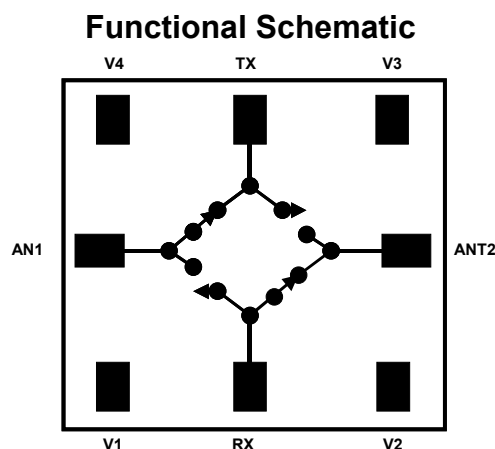

Description and Applications:

The FMS2017 is a low loss, single band Gallium Arsenide antenna diversity switch designed for use in Wireless LAN applications. The die is fabricated using the Filtronic FL05 0.5 μ m switch process technology that offers leading edge performance, optimised for switch applications. The FMS2017 is designed for use in 802.11b/g WLAN modules.

Electrical Specifications:

($T_{\text{AMBIENT}} = 25^{\circ}\text{C}$, $V_{\text{ctrl}} = 0\text{V}/(2.4\text{V}, +3.3\text{V})$, $Z_{\text{IN}} = Z_{\text{OUT}} = 50\Omega$)

Parameter	Conditions	Min	Typ	Max	Units
Insertion Loss (All Paths)	2.5GHz, Small Signal		0.55		dB
Isolation (All Paths)	2.5GHz, Small Signal		23		dB
Return Loss	2.5GHz, Small Signal		20		dB
P1dB	2.5GHz Control Voltage 3.0V		37		dBm
2nd Harmonic Level	2.4GHz, Pin = 32dBm, Vctrl = 2.4V		-65		dBc
3rd Harmonic Level	2.4GHz, Pin = 32dBm, Vctrl = 2.4V		-65		dBc
Switching speed	Vctrl=2.4V, Pin=20dBm		20		nS

Note: External DC blocking capacitors are required on all RF ports (typ: 47pF)
All unused ports terminated in 50 Ω .

Absolute Maximum Ratings:

Parameter	Symbol	Absolute Maximum
Max Input Power	Pin	+36dBm
Control Voltage	Vctrl	+5V
Operating Temperature	Toper	-40°C to +100°C
Storage Temperature	Tstor	-55°C to +150°C

Note: Exceeding any one of these absolute maximum ratings may cause permanent damage to the device.

Truth Table:

State	V1	V2	V3	V4	PATH(S)
1	High	Low	Low	Low	RX-ANT1
2	Low	High	Low	Low	RX-ANT2
3	Low	Low	High	Low	TX-ANT2
4	Low	Low	Low	High	TX-ANT1
5	Low	High	Low	High	TX-ANT1 & RX-ANT2
6	High	Low	High	Low	TX-ANT2 & RX-ANT1

Note: 'High' = +2.4V to +3.3V
 'Low' = 0V to +0.2V

Pad and Die Layout:

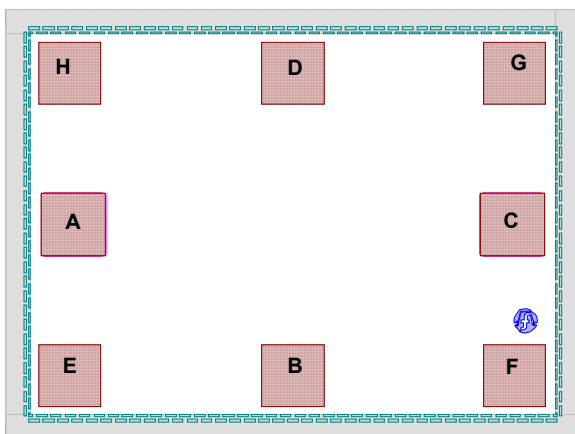

Pad Ref	Pad Name	Description	Pin Coordinates (µm)
A	ANT1	Antenna 1	(155, 300)
B	RX	Receive	(465, 90)
C	ANT2	Antenna 2	(775, 300)
D	TX	Transmit	(465, 510)
E	V1	Vctrl1 (A1 to RX)	(155, 90)
F	V2	Vctrl2 (A2 to RX)	(775, 90)
G	V3	Vctrl3 (TX to A2)	(775, 510)
H	V4	Vctrl4 (A1 to TX)	(155, 510)

Note: Co-ordinates are referenced from the bottom left hand corner of the die to the centre of the bond pad opening

Die Size (µm)	Die Thickness (µm)	Min. Bond Pad Pitch (µm)	Min. Bond pad opening (µm)
930x600	150	225	85x85

Typical Measured Performance on Evaluation Board (De-Embedded):

(Measurement Conditions $V_{CTRL}=3V$, $T_{AMBIENT} = 25^{\circ}C$ unless otherwise stated)

Insertion Loss

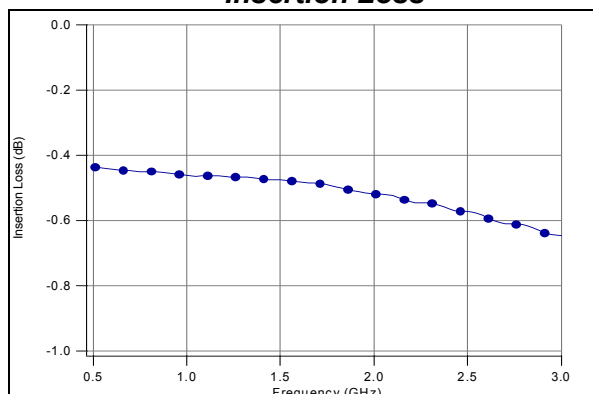

Tx-Rx Isolation

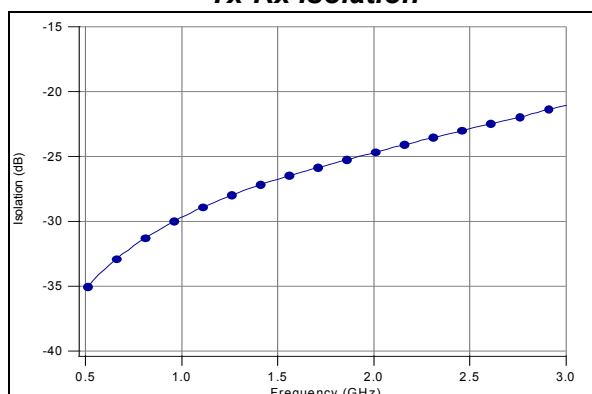

Return Loss

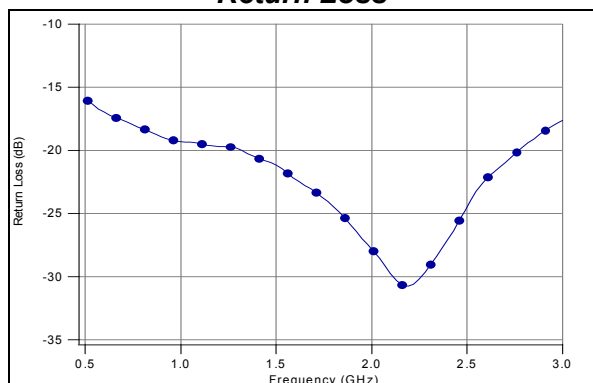

Insertion Loss vs Input Power

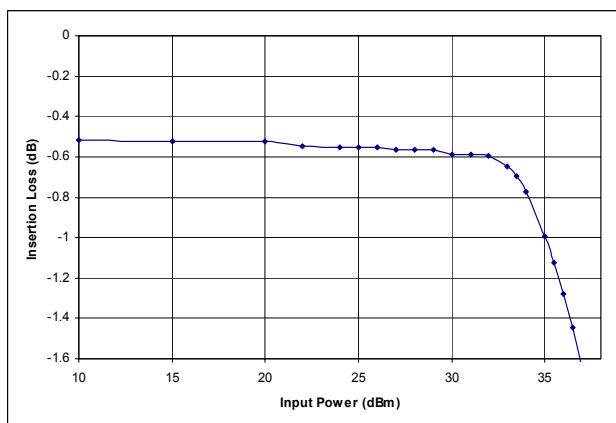

Insertion Loss vs Control Voltage

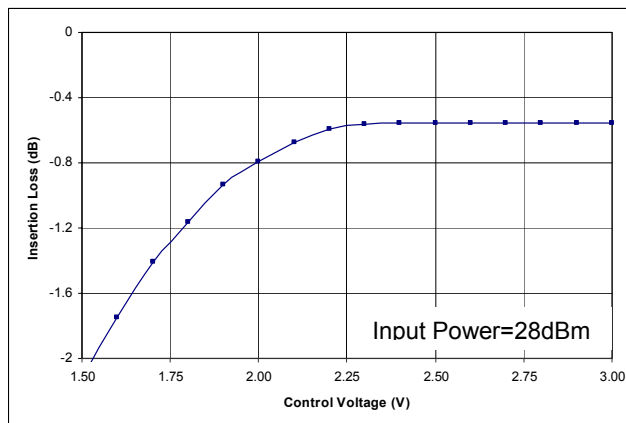

Evaluation Board:

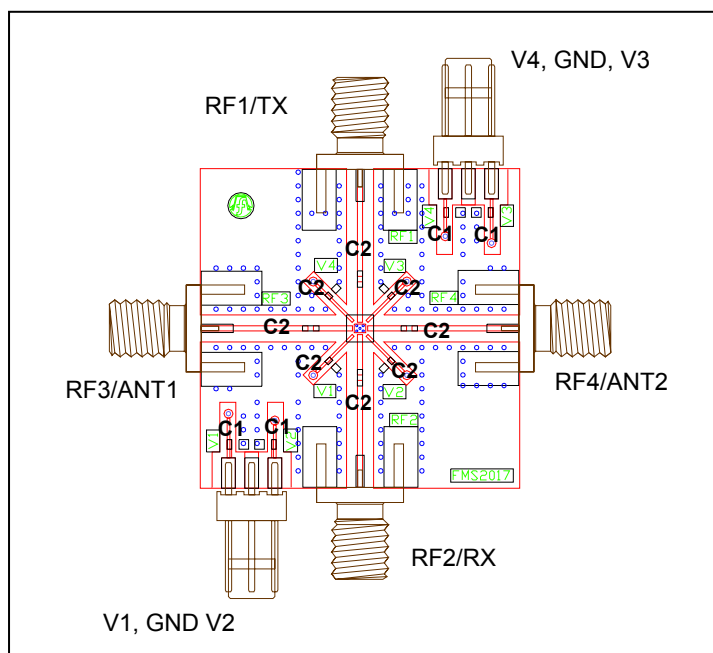

BOM

Label	Component
C1	Capacitor, 100pF, 0603
C2	Capacitor, 47pF, 0402
BOARD	Preferred evaluation board material is 0.25 mm thick ROGERS RT4350. All RF tracks should be 50 ohm characteristic impedance. Absolute placement of surface mount de-coupling capacitors is not critical.

Evaluation Board De-Embedding Data (Measured):

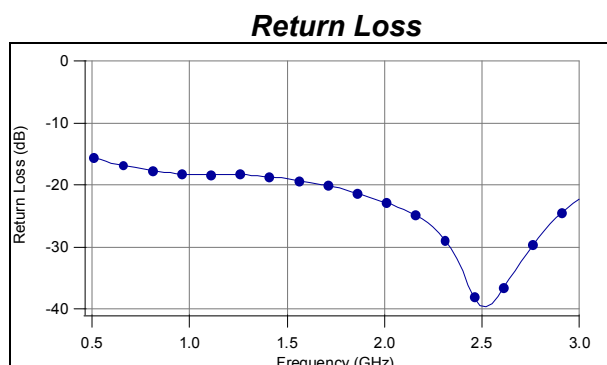
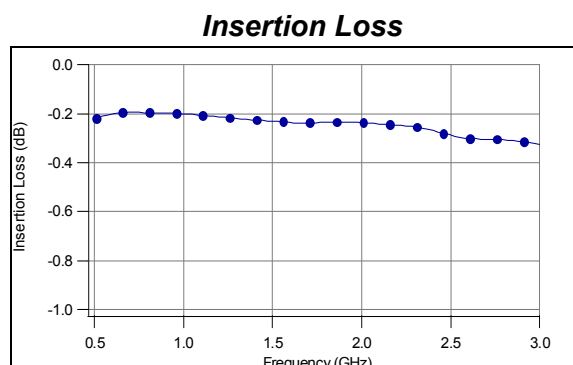

Ordering Information:

Part Number	Description
FMS2017-000-WP	Die – waffle pak
FMS2017-000-GP	Die – gel pak
FMS2017-000-EB	Die mounted on evaluation board
FMS2017-000-FF	Wafer mounted on film frame

Preferred Assembly Instructions:

GaAs devices are fragile and should be handled with great care. Specially designed collets should be used where possible.

The back of the die is not metallised and the recommended mounting method is by the use of conductive epoxy. Epoxy should be applied to the attachment surface uniformly and sparingly to avoid encroachment of epoxy on to the top face of the die and ideally should not exceed half the chip height. For automated dispense Ablestick LMISR4 is recommended and for manual dispense Ablestick 84-1 LMI or 84-1 LMIT are recommended. These should be cured at a temperature of 150°C for 1 hour in an oven especially set aside for epoxy curing only. If possible the curing oven should be flushed with dry nitrogen.

This part has gold (Au) bond pads requiring the use of gold (99.99% pure) bondwire. It is recommended that 25.4µm diameter gold wire is used. Thermosonic ball bonding is preferred. A nominal stage temperature of 150°C and a bonding force of 40g has been shown to give effective results for 25µm wire. Ultrasonic energy shall be kept to a minimum. For this bonding technique, stage temperature should not be raised above 200°C and bond force should not be raised above 60g. Thermosonic wedge bonding and thermocompression wedge bonding can also be used to achieve good wire bonds.

Bonds should be made from the die first and then to the mounting substrate or package. The physical length of the bondwires should be minimised especially when making RF or ground connections.

Handling Precautions:

To avoid damage to the devices care should be exercised during handling. Proper Electrostatic Discharge (ESD) precautions should be observed at all stages of storage, handling, assembly, and testing. These devices should be treated as Class 1A (0-500 V) as defined in JEDEC Standard No. 22-A114-B. Further information on ESD control measures can be found in MIL-STD-1686 and MIL-HDBK-263.

Disclaimers:

This product is not designed for use in any space based or life sustaining/supporting equipment.