



1.0 Hz to 100 kHz
Fixed Frequency

32 Pin DIP
6-Pole Filters

Description

The D76 and DP76 Series of low-power, fixed-frequency, linear active filters are high performance, 6-pole filters in a compact package. These Butterworth and Bessel low-pass and Butterworth high-pass filters (D76 only) combine linear active filter design with the space savings of a 32-pin dual in-line package (DIP). Each model comes factory tuned to a user-specified corner frequency between 1 Hz and 100 kHz (DP76, 1 Hz to 5kHz). These fully self-contained units require no external components or adjustments and operate with dynamic input voltage range from non-critical $\pm 5V$ to $\pm 18V$ power supplies.

Features/Benefits:

- Low cost solution for low frequency signal conditioning
- Compact DIP design minimizes board space requirements
- Plug-in ready-to-use, reducing engineering design and manufacturing time
- Factory tuned, no external clocks or adjustments needed saving time and labor of other discrete assembly solutions
- Low harmonic distortion and wide signal-to-noise ratio to 12 bit resolution

Applications

- Anti-alias filtering
- Vibration & shock analysis
- Automatic test equipment
- Aerospace, navigation and sonar
- Communication systems
- Medical electronics
- Sound and vibration testing
- Noise elimination
- Process control



Available Low-Pass Models:

D76L6B	6-pole Butterworth2
DP76L6B	6-pole Butterworth (Low Power)2
D76L6L	6-pole Bessel2
DP76L6L	6-pole Bessel (Low Power)2

Available High-Pass Models:

D76H6B	6-pole Butterworth2
---------------	--------------------	-------	----

General Specifications:

Pin-out/package data & ordering information3
---	--------



Fixed Frequency

6-Pole Low-Pass and High-Pass Filters

Model	D76L6B & DP76L6B	D76L6L & DP76L6L	Model	D76H6B
Product Specifications	Low-Pass	Low-Pass		High-Pass
Transfer Function	6-Pole, Butterworth	6-Pole, Bessel	Transfer Function	6-Pole, Butterworth,
Size D76 1.00 Hz to 1.00 kHz D76 1.01 kHz to 100 kHz DP76 1.00 Hz to 5.00 kHz	1.8" x 0.8" x 0.5" 1.8" x 0.8" x 0.3" 1.8" x 0.8" x 0.5"	1.8" x 0.8" x 0.5" 1.8" x 0.8" x 0.3" 1.8" x 0.8" x 0.5"	Size D76 1.00 Hz to 1.00 kHz D76 1.01 kHz to 100 kHz	1.8" x 0.8" x 0.5" 1.8" x 0.8" x 0.3"
Range f_c D76 DP76	1 Hz to 100 kHz 1 Hz to 5 kHz	1 Hz to 100 kHz 1 Hz to 5 kHz	Range f_c D76	1 Hz to 100 kHz
Theoretical Transfer Characteristics	Appendix A Page 8	Appendix A Page 3	Theoretical Transfer Characteristics	Appendix A Page 28
Passband Ripple (theoretical)	0.0 dB	0.0 dB	Passband Ripple (theoretical)	0.0 dB
DC Voltage Gain (non-inverting)	0 ± 0.1 dB typ.	0 ± 0.1 dB typ.	Voltage Gain (non-inverting)	0 ± 0.1 dB to 100 kHz
Stopband Attenuation Rate	36 dB/octave	36 dB/octave	Stopband Attenuation Rate	36 dB/octave
Power Bandwidth			Power Bandwidth	120 kHz
Small Signal Bandwidth			Small Signal Bandwidth	(-6 dB) 1 MHz
Cutoff Frequency Stability Amplitude Phase	f _c ± 2% max. ± 0.03% /°C -3 dB -270°	f _c ± 2% max. ± 0.03% /°C -3 dB -155°	Cutoff Frequency Stability Amplitude Phase	f _c ± 2% max. ± 0.03% /°C -3 dB -270°
Filter Attenuation (theoretical)	0.29 dB 0.80 f _c 3.01 dB 1.00 f _c 60.0 dB 3.16 f _c 80.0 dB 4.64 f _c	1.89 dB 0.80 f _c 3.01 dB 1.00 f _c 60.0 dB 5.41 f _c 80.0 dB 7.99 f _c	Filter Attenuation (theoretical)	80.0 dB .21 f _c 60.0 dB .32 f _c 3.01 dB 1.00 f _c 0.00 dB 2.50 f _c
Total Harmonic Distortion @ 1 kHz D76 DP76	<-70 dB <-70 dB	<-70 dB <-70 dB	Total Harmonic Distortion @ 1 kHz D76	<-70 dB
Wide Band Noise (5 Hz - 2 MHz)	200 μVrms typ.	200 μVrms typ.	Wide Band Noise (5 Hz - 2 MHz)	400 μVrms typ.
Narrow Band Noise (20 Hz - 100 kHz)	50 μVrms typ.	50 μVrms typ.	Narrow Band Noise (20 Hz - 100 kHz)	100 μVrms typ.
Filter Mounting Assembly	FMA-01A	FMA-01A	Filter Mounting Assembly	FMA-01A



Specification

(25°C and $V_s \pm 15$ Vdc)

Pin-Out and Package Data Ordering Information

Analog Input Characteristics¹

Impedance	10 k Ω min.
Voltage Range	± 10 V _{peak}
Max. Safe Voltage	$\pm V_s$

Analog Output Characteristics

Impedance	1 Ω
Linear Operating Range	± 10 V
Maximum Current ²	
D76	± 10 mA
DP76	± 5 mA
Offset Voltage	20 mV max. 3 mV typ.
Offset Temp. Coeff.	20 μ V / °C typ.

Power Supply ($\pm V$)

Rated Voltage	± 15 Vdc
Operating Range	± 5 to ± 18 Vdc
Maximum Safe Voltage	± 18 Vdc
Quiescent Current D76	9 mA max. 6.5 mA typ.
Quiescent Current DP76	2.0 mA max. 1.2 mA typ.

Temperature

Operating	0 to + 70 °C
Storage	- 25 to + 85 °C

Notes:

1. Input and output signal voltage referenced to supply common.
2. Output is short circuit protected to common. DO NOT CONNECT TO $\pm V_s$.

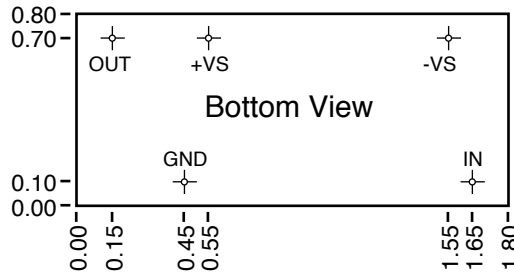
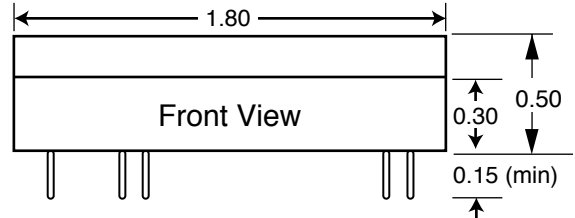
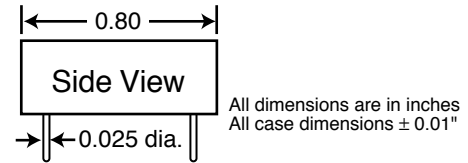

Filter Mounting Assembly-See FMA-01A

Ordering Information

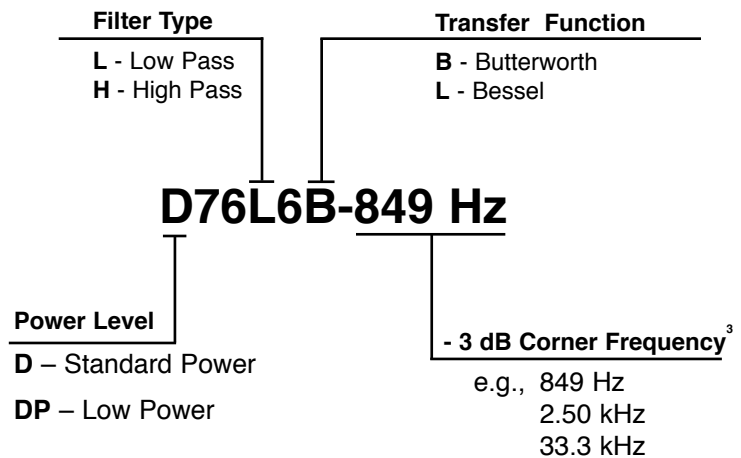

3. How to Specify Corner Frequency:

Corner frequencies are specified by attaching a three digit frequency designator to the basic model number. Corner frequencies can range from 1 Hz to 100 kHz.



Appendix A

Theoretical Transfer Characteristics

f/fc (Hz)	Amp (dB)	Phase (deg)	Delay ¹ (sec)
0.00	0.00	0.00	.430
0.10	-0.029	-15.5	.430
0.20	-0.116	-31.0	.430
0.30	-0.261	-46.5	.430
0.40	-0.465	-62.0	.430
0.50	-0.728	-77.4	.430
0.60	-1.05	-92.9	.430
0.70	-1.44	-108	.430
0.80	-1.89	-124	.430
0.85	-2.15	-132	.430
0.90	-2.42	-139	.430
0.95	-2.70	-147	.430
1.00	-3.01	-155	.430
1.10	-3.68	-170	.429
1.20	-4.44	-186	.428
1.30	-5.29	-201	.426
1.40	-6.23	-216	.422
1.50	-7.29	-232	.416
1.60	-8.46	-246	.401
1.70	-9.74	-261	.393
1.80	-11.1	-275	.376
1.90	-12.6	-287	.357
2.00	-14.2	-300	.335
2.25	-18.3	-328	.279
2.50	-22.6	-351	.228
2.75	-26.7	-369	.187
3.00	-30.7	-385	.156
3.25	-34.5	-398	.131
3.50	-38.1	-408	.111
4.00	-44.7	-426	.083
5.00	-55.9	-449	.052
6.00	-65.2	-465	.036
7.00	-73.2	-476	.026
8.00	-80.1	-484	.020
9.00	-86.2	-490	.015
10.0	-91.6	-495	.013

Frequency Response

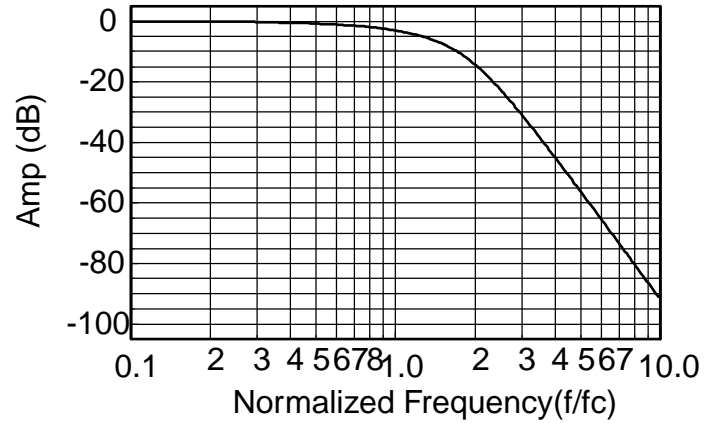

Delay (Normalized)

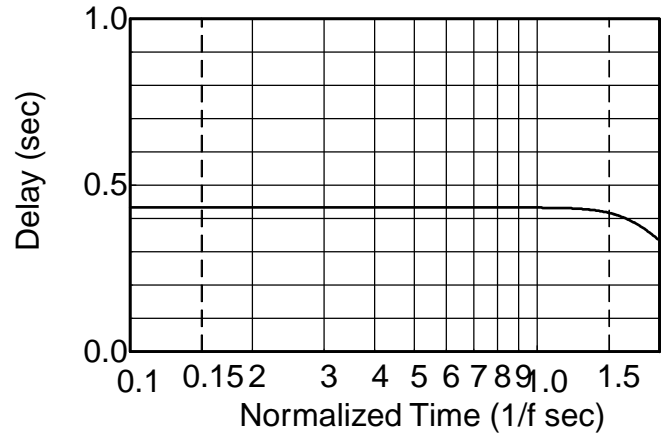

Step Response

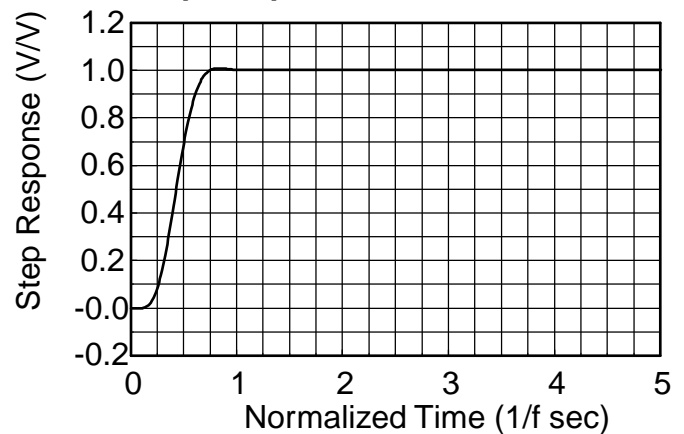

1. Normalized Group Delay:

The above delay data is normalized to a corner frequency of 1.0Hz. The actual delay is the normalized delay divided by the actual corner frequency (fc).

$$\text{Actual Delay} = \frac{\text{Normalized Delay}}{\text{Actual Corner Frequency (fc) in Hz}}$$



Appendix A

Theoretical Transfer Characteristics

f/fc (Hz)	Amp (dB)	Phase (deg)	Delay ¹ (sec)
0.00	0.00	0.00	.615
0.10	0.00	-22.2	.617
0.20	0.00	-44.5	.624
0.30	0.00	-67.2	.637
0.40	0.00	-90.4	.656
0.50	-0.001	-115	.685
0.60	-0.009	-140	.731
0.70	-0.060	-167	.803
0.80	-0.289	-198	.911
0.85	-0.578	-215	.970
0.90	-1.080	-233	1.02
0.95	-1.88	-252	1.03
1.00	-3.01	-270	1.00
1.10	-6.17	-304	.845
1.20	-9.96	-331	.660
1.30	-13.9	-352	.518
1.40	-17.6	-368	.417
1.50	-21.2	-382	.345
1.60	-24.5	-393	.291
1.70	-27.7	-403	.251
1.80	-30.6	-412	.219
1.90	-33.5	-419	.193
2.00	-36.1	-425	.171
2.25	-42.3	-439	.132
2.50	-47.8	-450	.105
2.75	-52.7	-458	.086
3.00	-57.3	-465	.071
3.25	-61.4	-471	.060
3.50	-65.3	-476	.052
4.00	-72.2	-484	.039
5.00	-83.9	-496	.025
6.00	-93.4	-503	.017
7.00	-101	-508	.012
8.00	-108	-512	.0097
9.00	-115	-515	.0076
10.0	-120	-518	.0062

Frequency Response

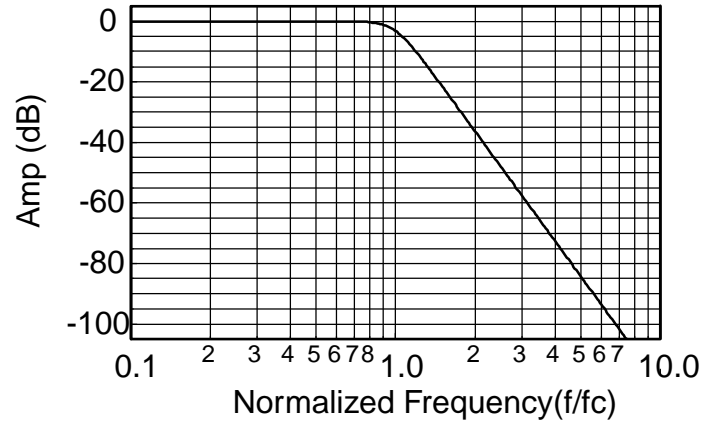

Delay (Normalized)

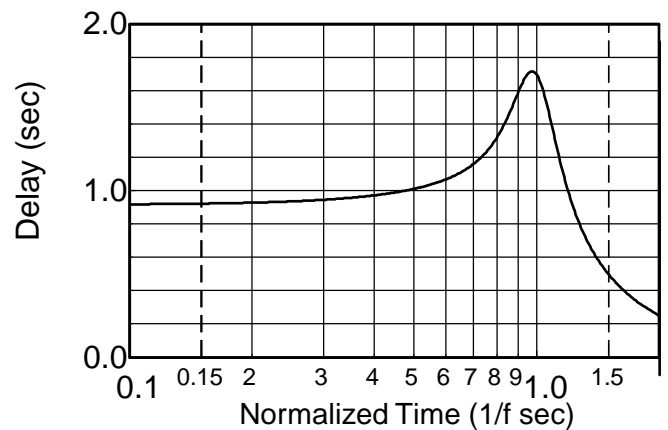

Step Response

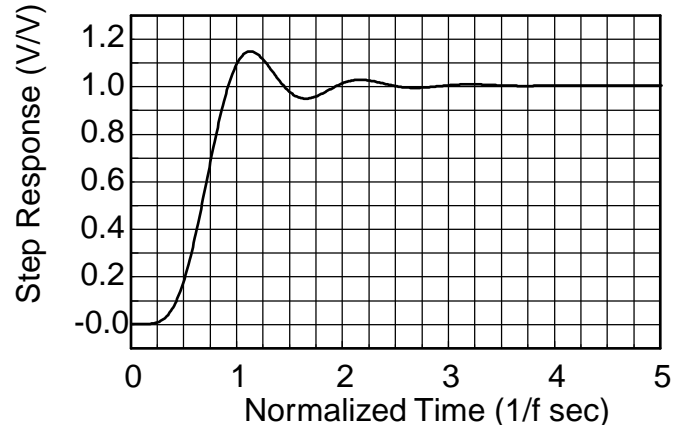

1. Normalized Group Delay:

The above delay data is normalized to a corner frequency of 1.0Hz. The actual delay is the normalized delay divided by the actual corner frequency (fc).

$$\text{Actual Delay} = \frac{\text{Normalized Delay}}{\text{Actual Corner Frequency (fc) in Hz}}$$



Theoretical Transfer Characteristics

f/fc (Hz)	Amp (dB)	Phase (deg)	Delay¹ (sec)
0.10	-120	518	0.617
0.20	-83.9	496	0.624
0.30	-62.7	473	0.637
0.40	-47.8	450	0.656
0.50	-36.1	425	0.685
0.60	-26.6	400	0.731
0.70	-18.6	373	0.803
0.80	-11.9	342	0.911
0.85	-9.05	325	0.970
0.90	-6.57	307	1.017
0.95	-4.55	288	1.033
1.00	-3.01	270	1.005
1.20	-0.46	209	0.660
1.40	-0.08	172	0.417
1.60	-0.02	147	0.291
1.80	-0.00	128	0.219
2.00	-0.00	115	0.171
2.50	-0.00	90.4	0.105
3.00	-0.00	74.8	0.071
4.00	0.00	55.8	0.039
5.00	0.00	44.5	0.025
6.00	0.00	37.0	0.017
7.00	0.00	31.7	0.013
8.00	0.00	27.7	0.010
9.00	0.00	24.6	0.008
10.0	0.00	22.2	0.006

Frequency Response

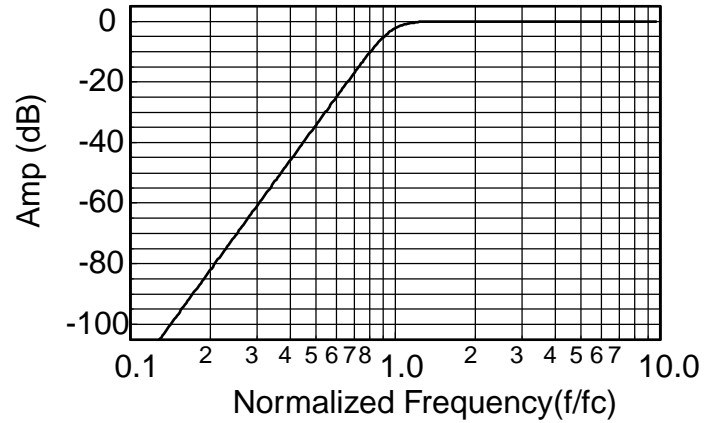

1. Normalized Group Delay:

The above delay data is normalized to a corner frequency of 1.0Hz. The actual delay is the normalized delay divided by the actual corner frequency (fc).

$$\text{Actual Delay} = \frac{\text{Normalized Delay}}{\text{Actual Corner Frequency (fc) in Hz}}$$