

PNP Silicon AF Transistors

- For AF input stages and driver applications
- High current gain
- Low collector-emitter saturation voltage
- Low noise between 30 Hz and 15 kHz
- Complementary types: BC846, BC847, BC848  
BC849, BC850 (NPN)

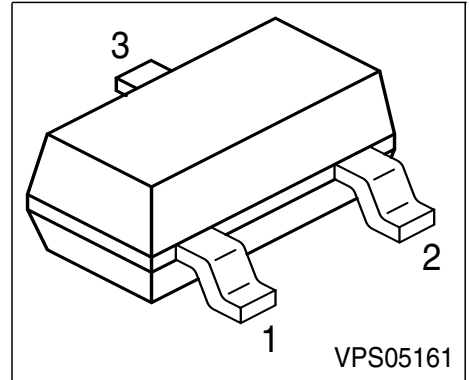

Type	Marking	Pin Configuration			Package
BC856A	3As	1 = B	2 = E	3 = C	SOT23
BC856B	3Bs	1 = B	2 = E	3 = C	SOT23
BC857A	3Es	1 = B	2 = E	3 = C	SOT23
BC857B	3Fs	1 = B	2 = E	3 = C	SOT23
BC857C	3Gs	1 = B	2 = E	3 = C	SOT23
BC858A	3Js	1 = B	2 = E	3 = C	SOT23
BC858B	3Ks	1 = B	2 = E	3 = C	SOT23
BC858C	3Ls	1 = B	2 = E	3 = C	SOT23
BC859A	4As	1 = B	2 = E	3 = C	SOT23
BC859B	4Bs	1 = B	2 = E	3 = C	SOT23
BC859C	4Cs	1 = B	2 = E	3 = C	SOT23
BC860B	4Fs	1 = B	2 = E	3 = C	SOT23
BC860C	4Gs	1 = B	2 = E	3 = C	SOT23

**Maximum Ratings**

Parameter	Symbol	BC856	BC857	BC858	Unit
			BC860	BC859	
Collector-emitter voltage	$V_{CEO}$	65	45	30	V
Collector-base voltage	$V_{CBO}$	80	50	30	
Collector-emitter voltage	$V_{CES}$	80	50	30	
Emitter-base voltage	$V_{EBO}$	5	5	5	
DC collector current	$I_C$	100			mA
Peak collector current	$I_{CM}$	200			mA
Peak base current	$I_{BM}$	200			
Peak emitter current	$I_{EM}$	200			
Total power dissipation, $T_S = 71\text{ °C}$	$P_{tot}$	330			mW
Junction temperature	$T_j$	150			°C
Storage temperature	$T_{stg}$	-65 ... 150			

**Thermal Resistance**

Junction - soldering point <sup>1)</sup>	$R_{thJS}$	≤240	K/W
--	------------	------	-----

**Electrical Characteristics** at  $T_A = 25\text{ °C}$ , unless otherwise specified.

Parameter	Symbol	Values			Unit	
		min.	typ.	max.		
Collector-emitter breakdown voltage $I_C = 10\text{ mA}$ , $I_B = 0$	$V_{(BR)CEO}$	BC856	65	-	-	V
		BC857/860	45	-	-	
		BC858/859	30	-	-	
Collector-base breakdown voltage $I_C = 10\text{ }\mu\text{A}$ , $I_E = 0$	$V_{(BR)CBO}$	BC856	80	-	-	
		BC857/860	50	-	-	
		BC858/859	30	-	-	

<sup>1)</sup>For calculation of  $R_{thJA}$  please refer to Application Note Thermal Resistance

**Electrical Characteristics** at  $T_A = 25^\circ\text{C}$ , unless otherwise specified.

Parameter	Symbol	Values			Unit	
		min.	typ.	max.		
<b>DC Characteristics</b>						
Collector-emitter breakdown voltage $I_C = 10 \mu\text{A}$ , $V_{BE} = 0$	$V_{(BR)CES}$	BC856	80	-	-	V
		BC857/860	50	-	-	
		BC858/859	30	-	-	
Emitter-base breakdown voltage $I_E = 1 \mu\text{A}$ , $I_C = 0$	$V_{(BR)EBO}$	5	-	-		
Collector cutoff current $V_{CB} = 30 \text{ V}$ , $I_E = 0$	$I_{CBO}$	-	-	15	nA	
Collector cutoff current $V_{CB} = 30 \text{ V}$ , $I_E = 0$ , $T_A = 150^\circ\text{C}$	$I_{CBO}$	-	-	5	$\mu\text{A}$	
DC current gain 1) $I_C = 10 \mu\text{A}$ , $V_{CE} = 5 \text{ V}$	$h_{FE}$	$h_{FE}$ -group <b>A</b>	-	140	-	-
		$h_{FE}$ -group <b>B</b>	-	250	-	
		$h_{FE}$ -group <b>C</b>	-	480	-	
DC current gain 1) $I_C = 2 \text{ mA}$ , $V_{CE} = 5 \text{ V}$	$h_{FE}$	$h_{FE}$ -group <b>A</b>	125	180	250	
		$h_{FE}$ -group <b>B</b>	220	290	475	
		$h_{FE}$ -group <b>C</b>	420	520	800	
Collector-emitter saturation voltage 1) $I_C = 10 \text{ mA}$ , $I_B = 0.5 \text{ mA}$ $I_C = 100 \text{ mA}$ , $I_B = 5 \text{ mA}$	$V_{CEsat}$		-	75	300	mV
			-	250	650	
Base-emitter saturation voltage 1) $I_C = 10 \text{ mA}$ , $I_B = 0.5 \text{ mA}$ $I_C = 100 \text{ mA}$ , $I_B = 5 \text{ mA}$	$V_{BEsat}$		-	700	-	
			-	850	-	
Base-emitter voltage 1) $I_C = 2 \text{ mA}$ , $V_{CE} = 5 \text{ V}$ $I_C = 10 \text{ mA}$ , $V_{CE} = 5 \text{ V}$	$V_{BE(ON)}$		600	650	750	
			-	-	820	

 1) Pulse test:  $t \leq 300 \mu\text{s}$ ,  $D = 2\%$

**Electrical Characteristics** at  $T_A = 25^\circ\text{C}$ , unless otherwise specified.

Parameter	Symbol	Values			Unit
		min.	typ.	max.	
<b>AC Characteristics</b>					
Transition frequency $I_C = 20\text{ mA}, V_{CE} = 5\text{ V}, f = 100\text{ MHz}$	$f_T$	-	250	-	MHz
Collector-base capacitance $V_{CB} = 10\text{ V}, f = 1\text{ MHz}$	$C_{cb}$	-	3	-	pF
Emitter-base capacitance $V_{EB} = 0.5\text{ V}, f = 1\text{ MHz}$	$C_{eb}$	-	8	-	
Short-circuit input impedance $I_C = 2\text{ mA}, V_{CE} = 5\text{ V}, f = 1\text{ kHz}$	$h_{11e}$				k $\Omega$
$h_{FE-gr.A}$		-	2.7	-	
$h_{FE-gr.B}$		-	4.5	-	
$h_{FE-gr.C}$		-	8.7	-	
Open-circuit reverse voltage transf.ratio $I_C = 2\text{ mA}, V_{CE} = 5\text{ V}, f = 1\text{ kHz}$	$h_{12e}$				$10^{-4}$
$h_{FE-gr.A}$		-	1.5	-	
$h_{FE-gr.B}$		-	2	-	
$h_{FE-gr.C}$		-	3	-	
Short-circuit forward current transf.ratio $I_C = 2\text{ mA}, V_{CE} = 5\text{ V}, f = 1\text{ kHz}$	$h_{21e}$				-
$h_{FE-gr.A}$		-	200	-	
$h_{FE-gr.B}$		-	330	-	
$h_{FE-gr.C}$		-	600	-	
Open-circuit output admittance $I_C = 2\text{ mA}, V_{CE} = 5\text{ V}, f = 1\text{ kHz}$	$h_{22e}$				$\mu\text{S}$
$h_{FE-gr.A}$		-	18	-	
$h_{FE-gr.B}$		-	30	-	
$h_{FE-gr.C}$		-	60	-	
Noise figure $I_C = 0.2\text{ mA}, V_{CE} = 5\text{ V}, R_S = 2\text{ k}\Omega,$ $f = 1\text{ kHz}, \Delta f = 200\text{ Hz}$	$F$	-	1	4	dB
					BC 859
					BC 860
Equivalent noise voltage $I_C = 200\text{ }\mu\text{A}, V_{CE} = 5\text{ V}, R_S = 2\text{ k}\Omega,$ $f = 10 \dots 50\text{ Hz}$	$V_n$	-	-	0.11	$\mu\text{V}$
					BC 860

**Total power dissipation  $P_{tot} = f(T_S)$**

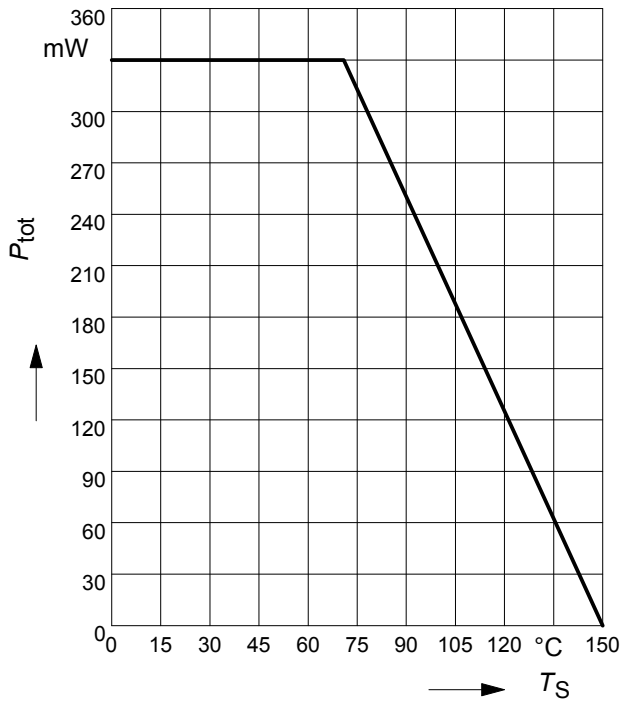

**Collector-base capacitance  $C_{CB} = f(V_{CBO})$   
Emitter-base capacitance  $C_{EB} = f(V_{EBO})$**

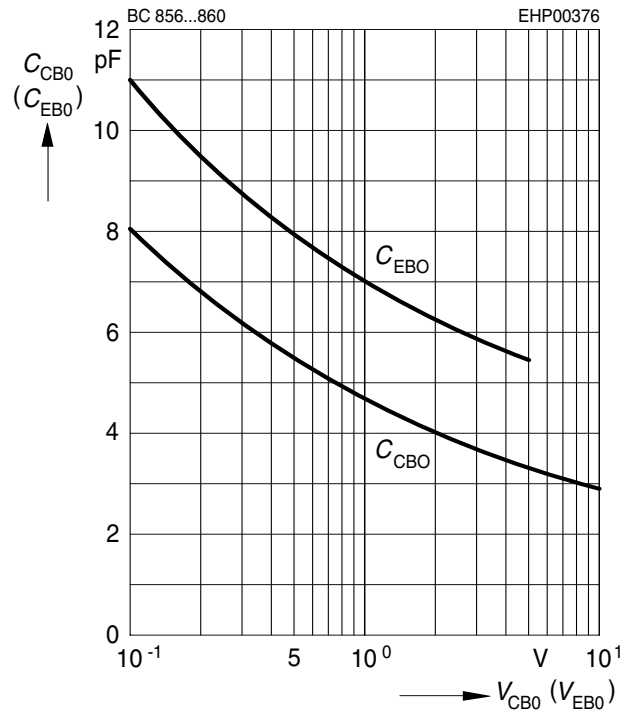

**Permissible pulse load**

$P_{totmax} / P_{totDC} = f(t_p)$

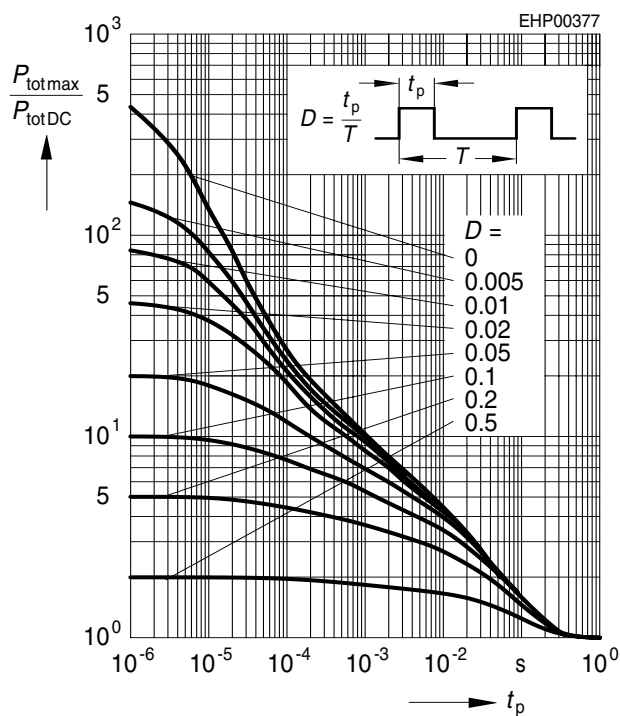

**Transition frequency  $f_T = f(I_C)$**

$V_{CE} = 5V$

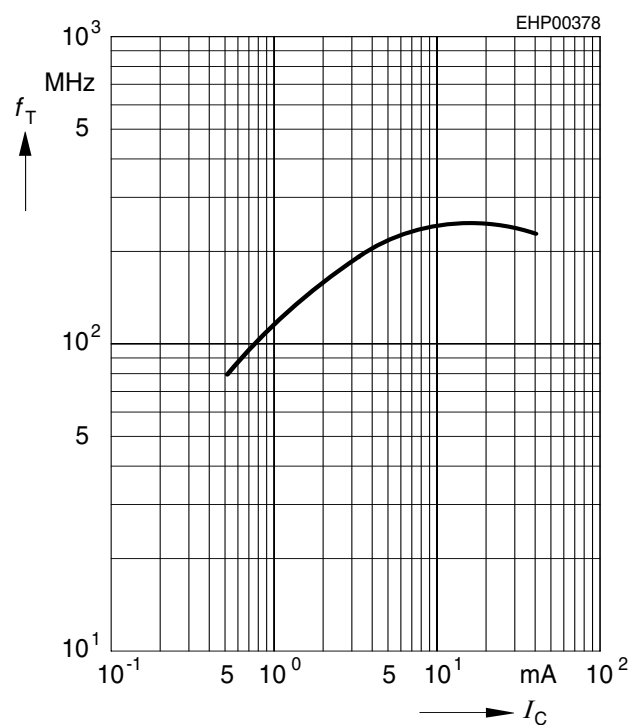

**Collector cutoff current  $I_{CBO} = f(T_A)$**

$V_{CB} = 30V$

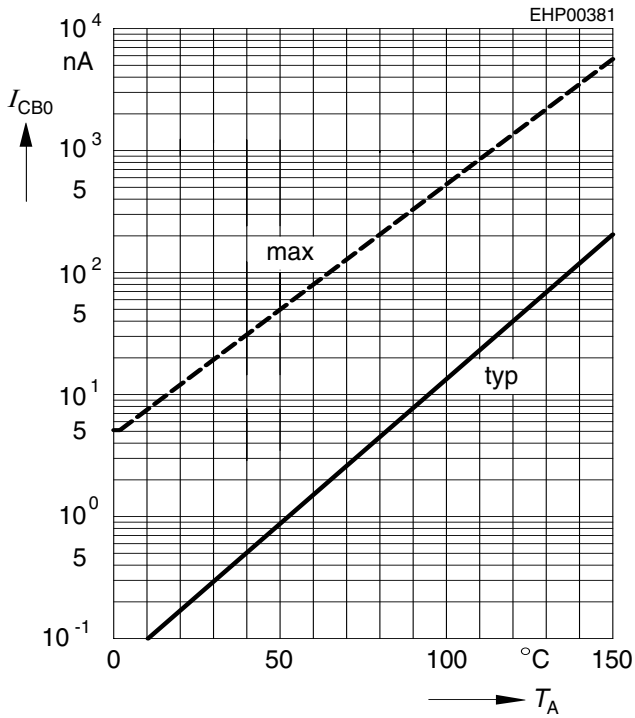

**Collector-emitter saturation voltage**

$I_C = f(V_{CEsat}), h_{FE} = 20$

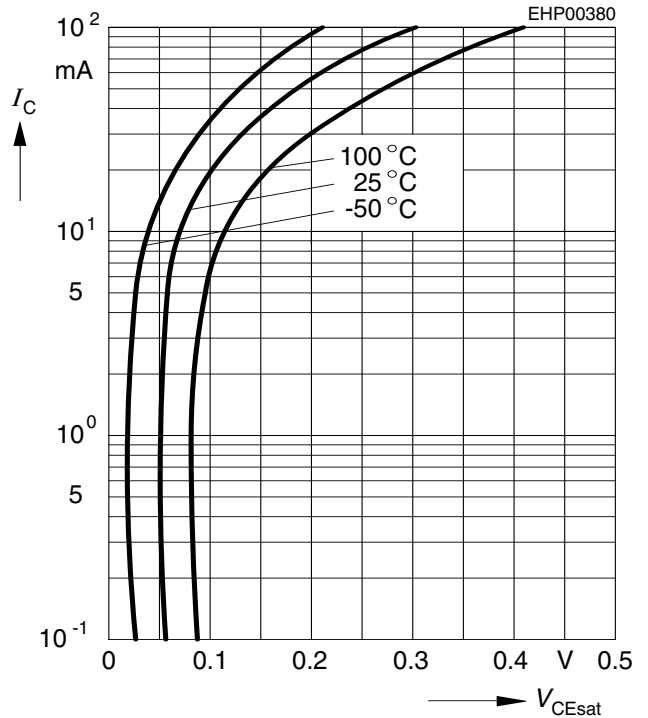

**DC current gain  $h_{FE} = f(I_C)$**

$V_{CE} = 5V$

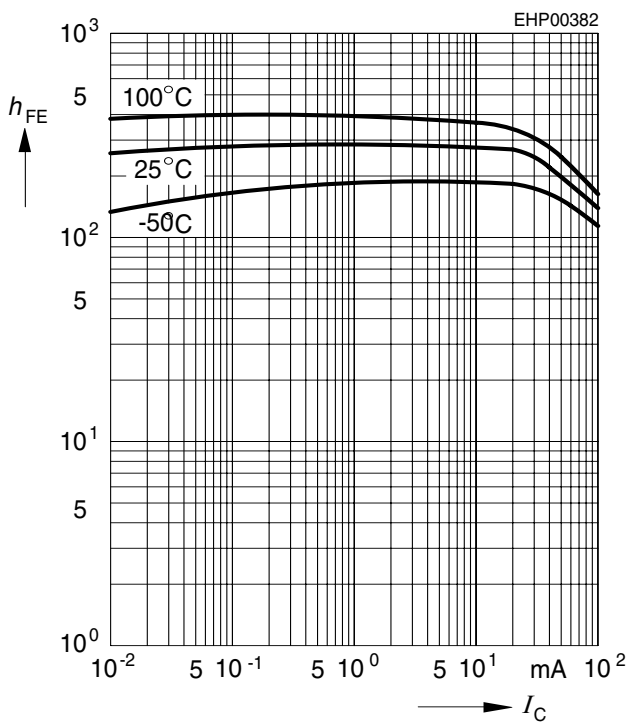

**Base-emitter saturation voltage**

$I_C = f(V_{BEsat}), h_{FE} = 20$

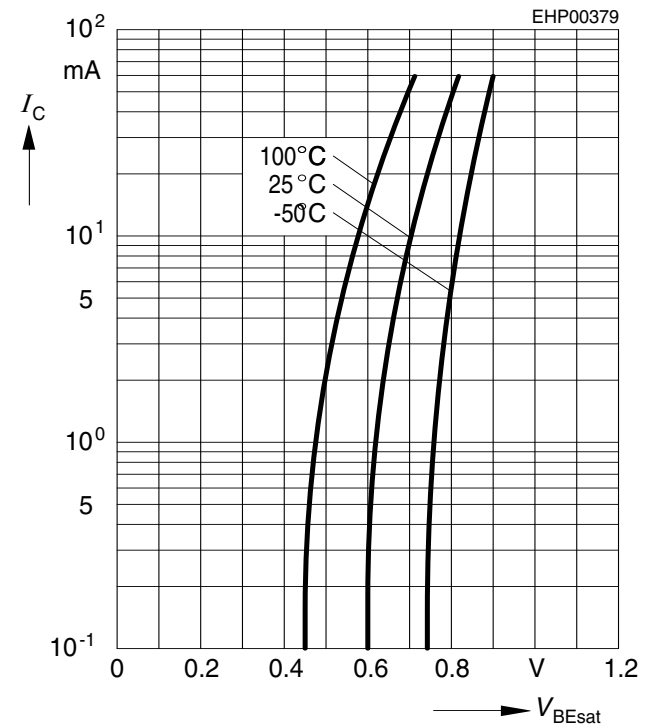

**h parameter  $h_e = f(I_C)$  normalized**

$V_{CE} = 5V$

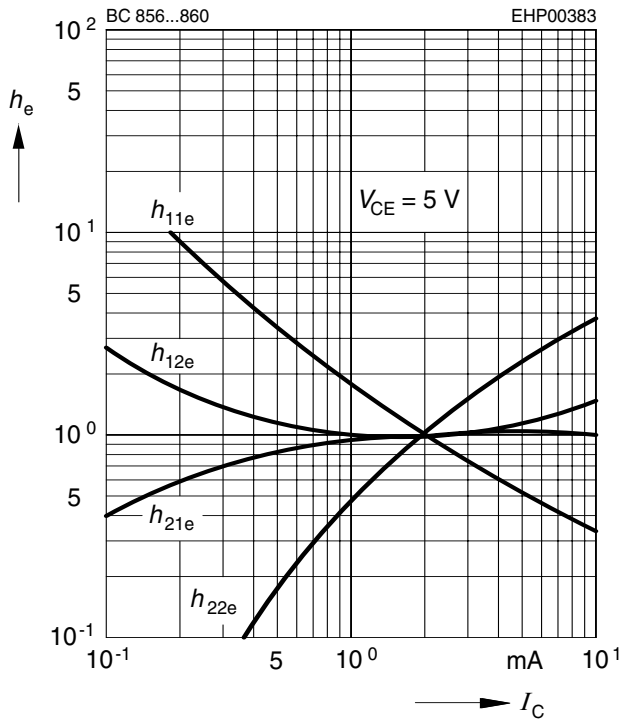

**h parameter  $h_e = f(V_{CE})$  normalized**

$I_C = 2mA$

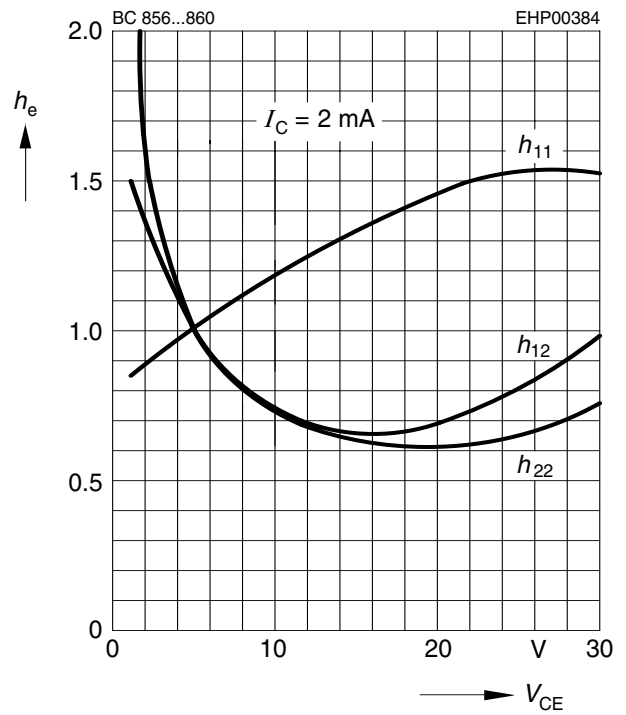

**Noise figure  $F = f(V_{CE})$**

$I_C = 0.2mA$ ,  $R_S = 2k\Omega$ ,  $f = 1kHz$

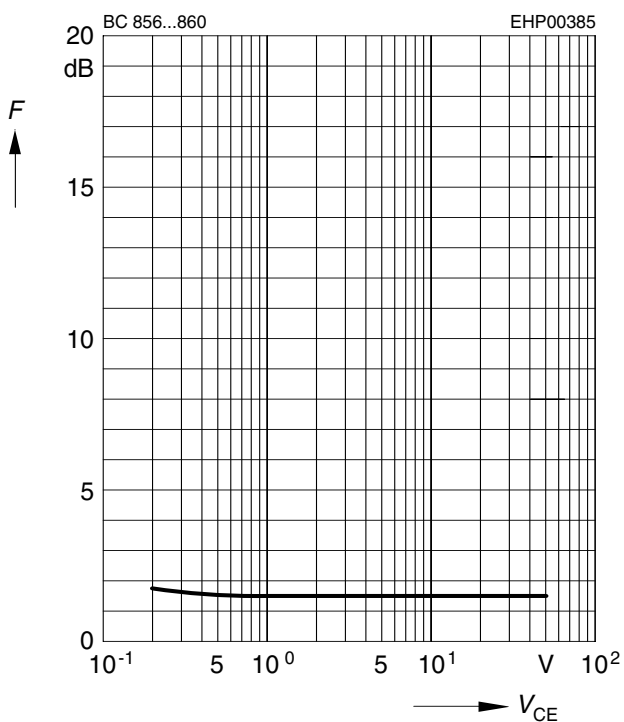

**Noise figure  $F = f(f)$**

$I_C = 0.2mA$ ,  $V_{CE} = 5V$ ,  $R_S = 2k\Omega$

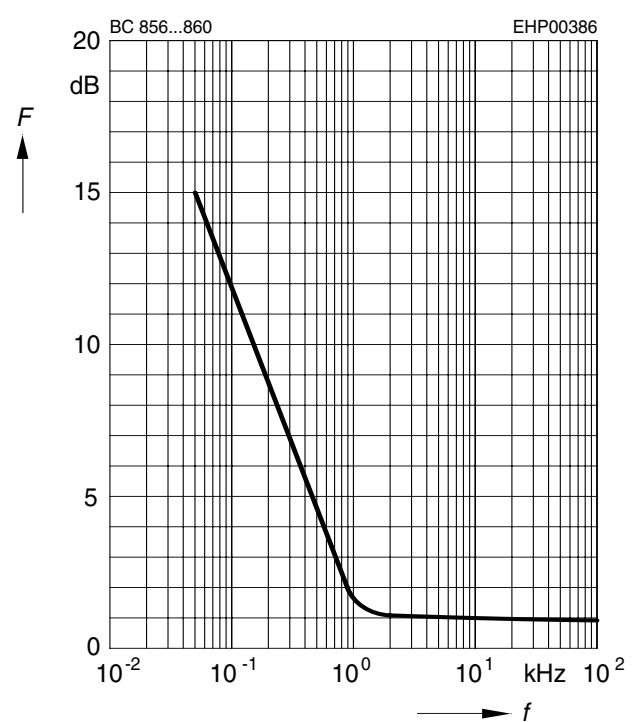

**Noise figure  $F = f(I_C)$**

$V_{CE} = 5V, f = 120Hz$

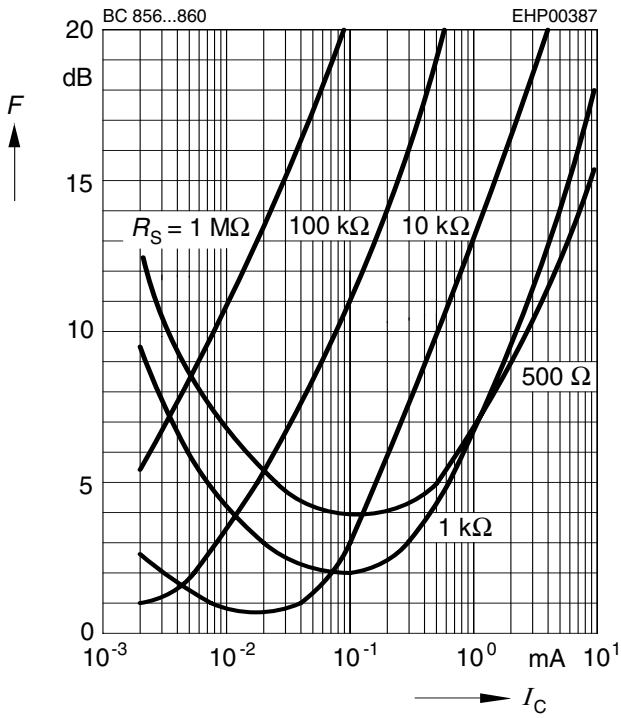

**Noise figure  $F = f(I_C)$**

$V_{CE} = 5V, f = 1kHz$

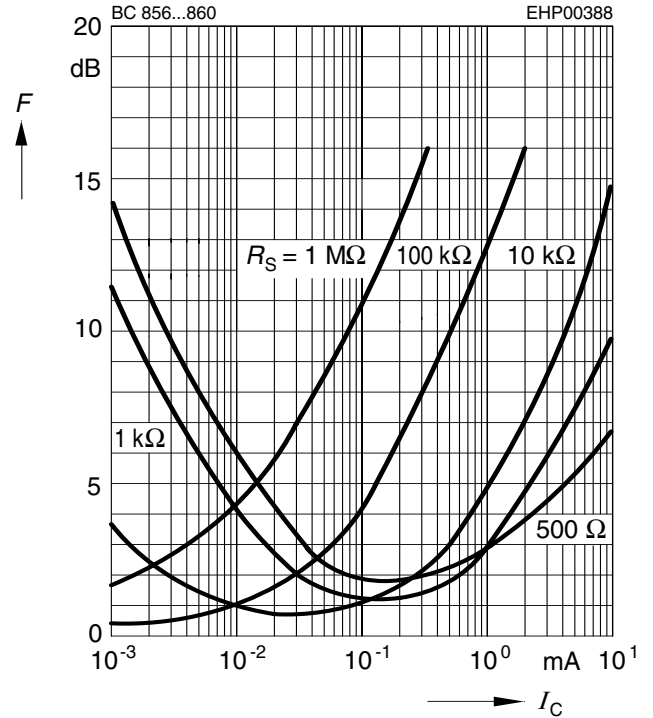

**Noise figure  $F = f(I_C)$**

$V_{CE} = 5V, f = 10kHz$

