

Hyper TOPLED® White Hyper-Bright LED

LW T673



Vorläufige Daten / Preliminary Data

Besondere Merkmale

- **Gehäusetyyp:** weißes P-LCC-2 Gehäuse
- **Besonderheit des Bauteils:** extrem breite Abstrahlcharakteristik; ideal für Hinterleuchtungen und Einkopplungen in Lichtleiter
- **Farbort:** $x = 0,32$, $y = 0,31$ nach CIE 1931 (weiß)
- **typische Farbtemperatur:** 6500 K
- **Farbwiedergabeindex:** 85
- **Abstrahlwinkel:** Lambertischer Strahler (120°)
- **Technologie:** InGaN
- **optischer Wirkungsgrad:** 6 lm/W
- **Gruppierungsparameter:** Lichtstärke, Farbort
- **Verarbeitungsmethode:** für alle SMT-Bestücktechniken geeignet
- **Lötmethode:** IR Reflow Löten und Wellenlöten (TTW)
- **Vorbehandlung:** nach JEDEC Level 2
- **Gurtung:** 8 mm Gurt mit 2000/Rolle, $\varnothing 180$ mm oder 8000/Rolle, $\varnothing 330$ mm
- **ESD-Festigkeit:** ESD-sicher bis 2 kV nach MIL STD 883 D, Method 3015.7

Anwendungen

- Informationsanzeigen im Außenbereich
- Hinterleuchtung (LCD, Schalter, Tasten, Displays, Werbebeleuchtung)
- Innen- und Außenbeleuchtung im Automobilbereich
- Ersatz von Kleinst-Glühlampen, Leselampen
- Rettungsnotleuchten
- Signal- und Symbolleuchten
- Markierungsbeleuchtung (z.B. Stufen, Fluchtwege, u.ä.)
- Scanner

Features

- **package:** white P-LCC-2 package
- **feature of the device:** extremely wide viewing angle; ideal for backlighting and coupling in light guides
- **color coordinates:** $x = 0.32$, $y = 0.31$ acc. to CIE 1931 (white)
- **typ. color temperature:** 6500 K
- **color reproduction index:** 85
- **viewing angle:** Lambertian Emitter (120°)
- **technology:** InGaN
- **optical efficiency:** 6 lm/W
- **grouping parameter:** luminous intensity, color coordinates
- **assembly methods:** suitable for all SMT assembly methods
- **soldering methods:** IR reflow soldering and TTW soldering
- **preconditioning:** acc. to JEDEC Level 2
- **taping:** 8 mm tape with 2000/reel, $\varnothing 180$ mm or 8000/reel, $\varnothing 330$ mm
- **ESD-withstand voltage:** up to 2 kV acc. to MIL STD 883 D, Method 3015.7

Applications

- outdoor displays
- backlighting (LCD, switches, keys, displays, illuminated advertising)
- interior and exterior automotive lighting
- substitution of micro incandescent lamps, reading lamps
- emergency lighting
- signal and symbol luminaire
- marker lights (e.g. steps, exit ways, etc.)
- scanners

Typ	Emissions- farbe	Farbe der Lichtaustritts- fläche	Lichtstärke	Lichtstrom	Bestellnummer
Type	Color of Emission	Color of the Light Emitting Area	Luminous Intensity $I_F = 20 \text{ mA}$ $I_V \text{ (mcd)}$	Luminous Flux $I_F = 20 \text{ mA}$ $\Phi_V \text{ (lm)}$	Ordering Code
LW T673-Q2R2-1	white	colored diffused	90 ... 180	405 (typ.)	Q62703-Q4836
LW T673-R2S2-1			140 ... 280	630 (typ.)	Q62703-Q4686
LW T673-Q2			90 ... 112	303 (typ.)	
LW T673-R1			112 ... 140	378 (typ.)	
LW T673-R2			140 ... 180	480 (typ.)	
LW T673-S1			180 ... 224	606 (typ.)	
LW T673-S2			224 ... 280	756 (typ.)	

Helligkeitswerte werden mit einer Stromeinprägedauer von 25 ms und einer Genauigkeit von $\pm 11 \%$ ermittelt.

Luminous intensity is tested at a current pulse duration of 25 ms and an accuracy of $\pm 11 \%$.

-1 Farbselektiert nach Farbortgruppen (siehe Seite 5).

-1 Color selection acc. to Chromaticity coordinate groups (see page 5).

Grenzwerte
Maximum Ratings

Bezeichnung Parameter	Symbol Symbol	Wert Value	Einheit Unit
Betriebstemperatur Operating temperature range	T_{op}	- 40 ... + 100	°C
Lagertemperatur Storage temperature range	T_{stg}	- 40 ... + 100	°C
Sperrschichttemperatur Junction temperature	T_j	+ 110	°C
Durchlassstrom Forward current	I_F	20	mA
Stoßstrom Surge current $t \leq 10 \mu s, D = 0.005$	I_{FM}	200	mA
Sperrspannung Reverse voltage	V_R	5	V
Leistungsaufnahme Power dissipation $T_A \leq 25 \text{ °C}$	P_{tot}	85	mW
Wärmewiderstand Thermal resistance Sperrschicht/Umgebung Junction/ambient Sperrschicht/Lötpad Junction/solder point Montage auf PC-Board FR 4 (Padgröße $\geq 16 \text{ mm}^2$) mounted on PC board FR 4 (pad size $\geq 16 \text{ mm}^2$)	$R_{th JA}$ $R_{th JS}$	400 180	K/W K/W

Kennwerte ($T_A = 25\text{ °C}$)**Characteristics**

Bezeichnung Parameter	Symbol Symbol	Wert Value	Einheit Unit
Farbkoordinate x nach CIE 1931 ¹⁾ (typ.) Chromaticity coordinate x acc. to CIE 1931 ¹⁾ $I_F = 20\text{ mA}$	x	0.32	–
Farbkoordinate y nach CIE 1931 ¹⁾ (typ.) Chromaticity coordinate y acc. to CIE 1931 ¹⁾ $I_F = 20\text{ mA}$	y	0.31	–
Abstrahlwinkel bei 50 % I_V (Vollwinkel) (typ.) Viewing angle at 50 % I_V	2φ	120	Grad deg.
Durchlassspannung (typ.) Forward voltage (max.) $I_F = 20\text{ mA}$	V_F V_F	3.5 4.2	V V
Sperrstrom (typ.) Reverse current (max.) $V_R = 5\text{ V}$	I_R I_R	0.01 10	μA μA
Temperaturkoeffizient von x (typ.) Temperature coefficient of x $I_F = 20\text{ mA}; -10\text{ °C} \leq T \leq 100\text{ °C}$	TC_x	0.1	$10^{-3}/\text{K}$
Temperaturkoeffizient von y (typ.) Temperature coefficient of y $I_F = 20\text{ mA}; -10\text{ °C} \leq T \leq 100\text{ °C}$	TC_y	0.3	$10^{-3}/\text{K}$
Temperaturkoeffizient von V_F (typ.) Temperature coefficient of V_F $I_F = 20\text{ mA}; -10\text{ °C} \leq T \leq 100\text{ °C}$	TC_V	– 3.0	mV/K
Optischer Wirkungsgrad (typ.) Optical efficiency $I_F = 20\text{ mA}$	η_{opt}	6	lm/W

1) **Farbortgruppen**
Chromaticity coordinate groups

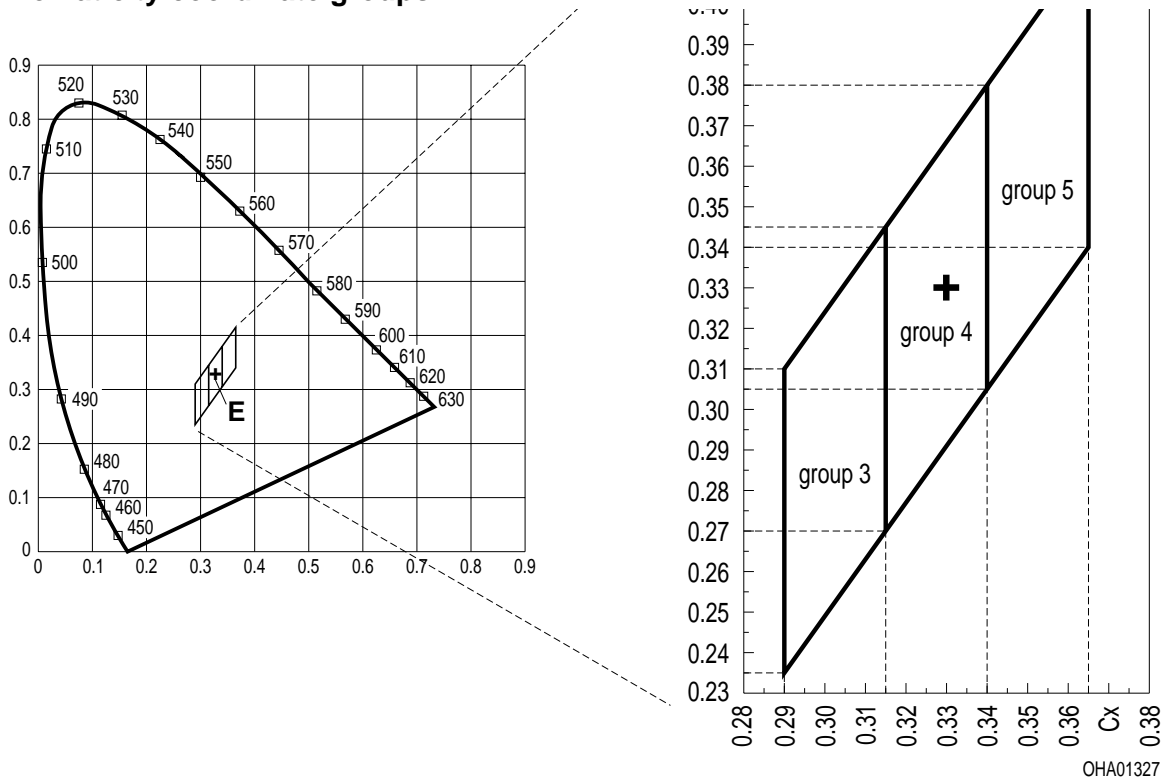

Farbortgruppen werden mit einer Stromeinprägedauer von 25 ms und einer Genauigkeit von $\pm 0,01$ ermittelt.

Chromaticity coordinate groups are tested at a current pulse duration of 25 ms and an accuracy of ± 0.01 .

Gruppenbezeichnung auf Etikett
Group Name on Label

Beispiel: R2-4

Example: R2-4

Lichtgruppe Luminous Intensity Group	Halbgruppe Half Group	Farbortgruppe Chromaticity coordinate Group
R	2	4

Relative spektrale Emission $I_{rel} = f(\lambda)$, $T_A = 25\text{ °C}$, $I_F = 20\text{ mA}$

Relative Spectral Emission

$V(\lambda)$ = spektrale Augenempfindlichkeit

Standard eye response curve

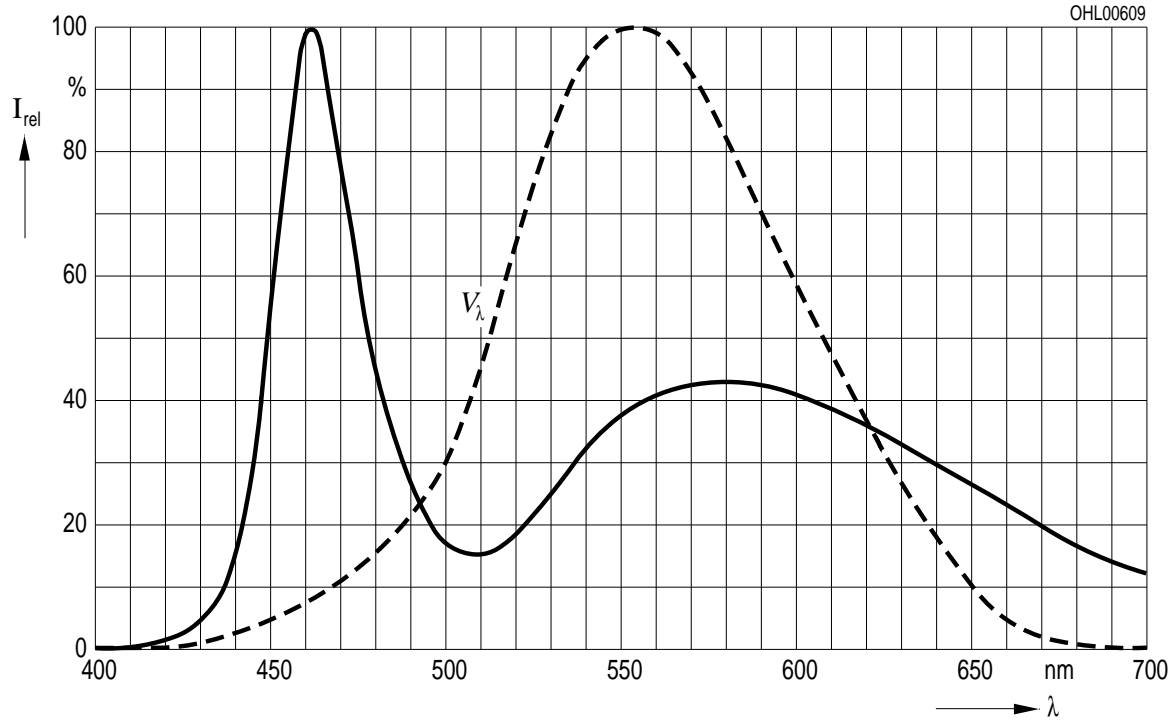

Abstrahlcharakteristik $I_{rel} = f(\varphi)$

Radiation Characteristic

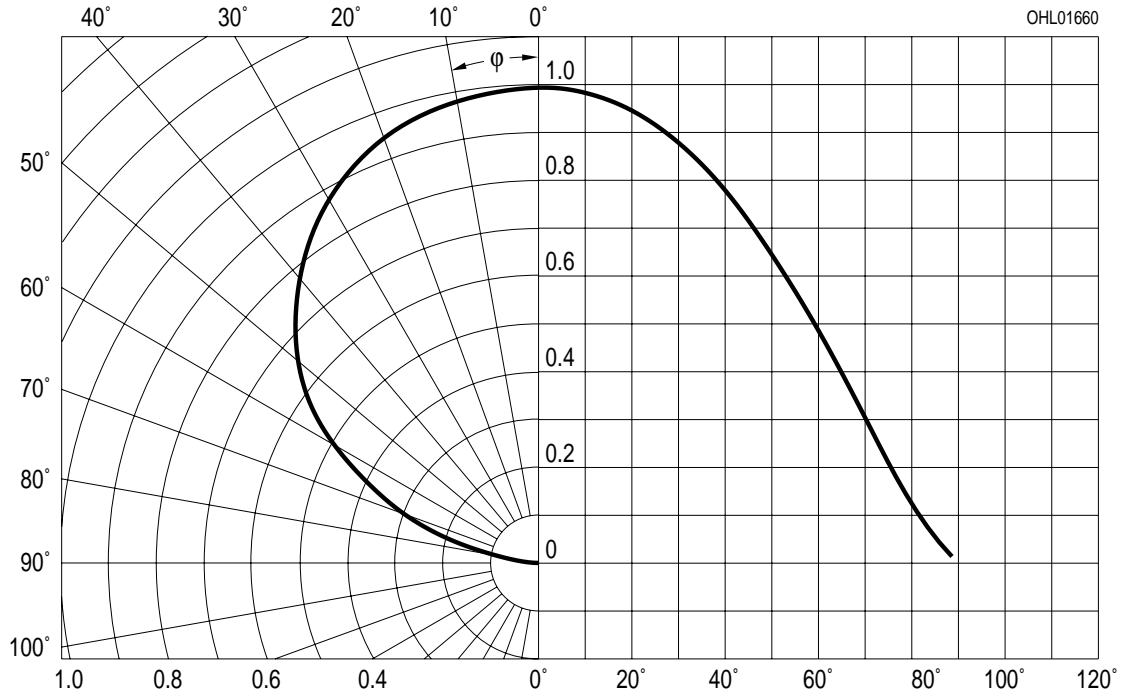

Durchlassstrom $I_F = f(V_F)$

Forward Current

$T_A = 25\text{ °C}$

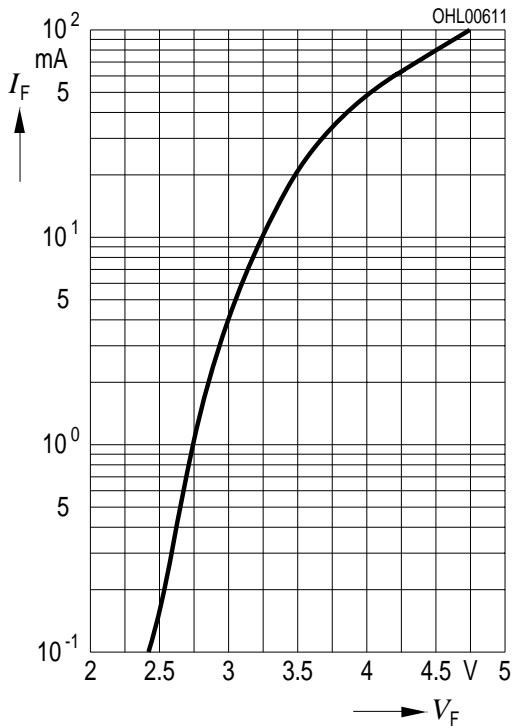

Relative Lichtstärke $I_V/I_{V(20\text{ mA})} = f(I_F)$

Relative Luminous Intensity

$T_A = 25\text{ °C}$

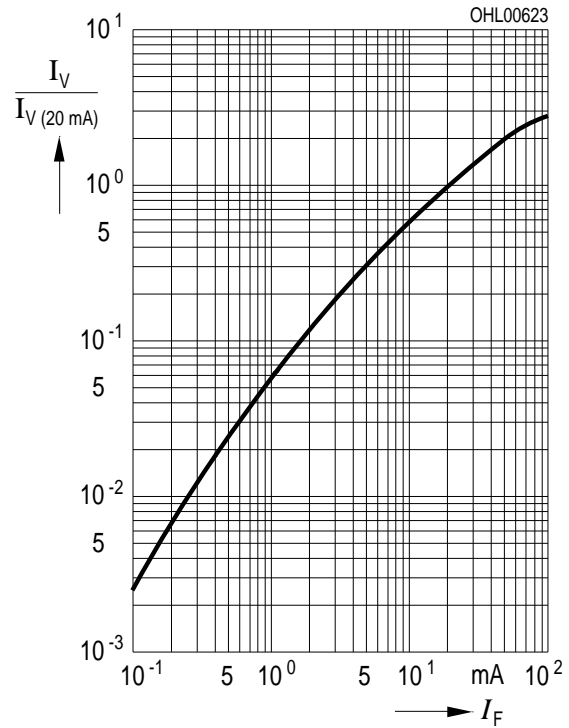

Maximal zulässiger Durchlassstrom $I_F = f(T)$

Max. Permissible Forward Current

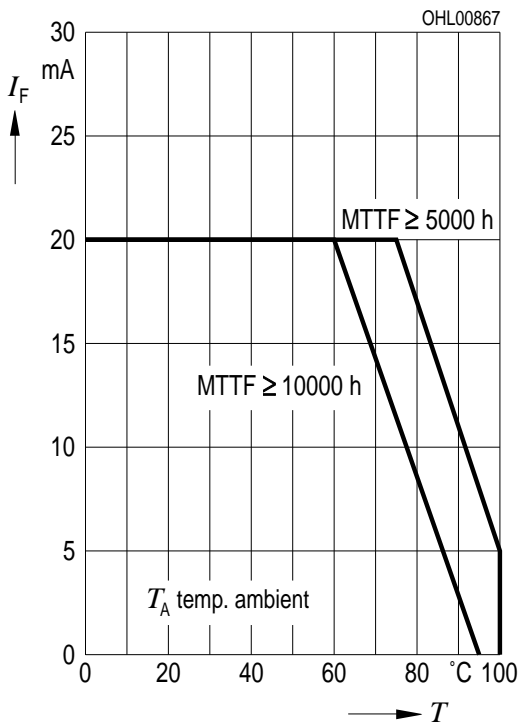

Maximal zulässiger Durchlassstrom $I_F = f(T)$

Max. Permissible Forward Current

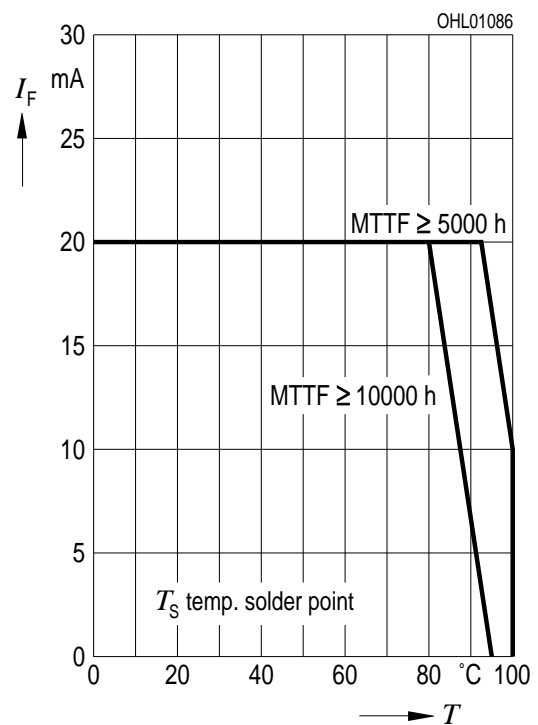

Relative Lichtstärke $I_V/I_{V(25^\circ\text{C})} = f(T_A)$
Relative Luminous Intensity
 $I_F = 20 \text{ mA}$

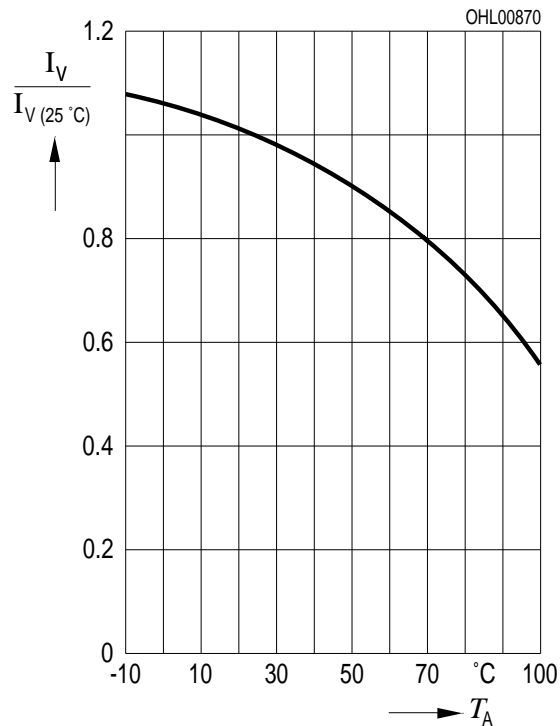

Farbortverschiebung $x, y = f(I_F)$
Chromaticity Coordinate Shift
 $T_A = 25^\circ\text{C}$

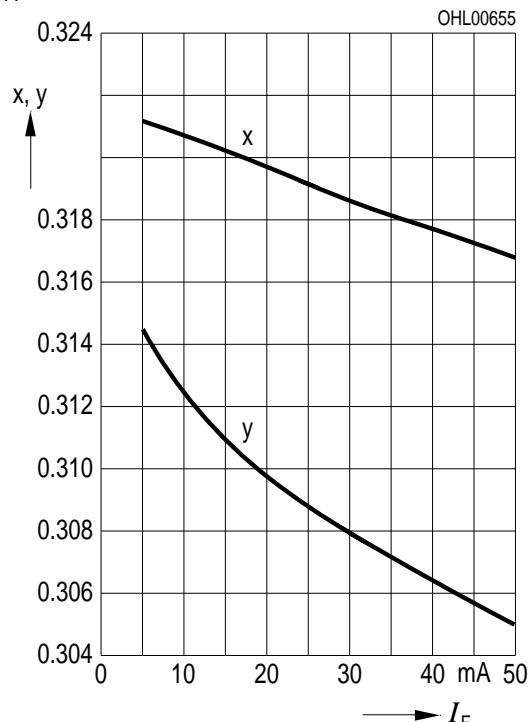

Zulässige Impulsbelastbarkeit $I_F = f(t_p)$
Permissible Pulse Handling Capability
 Duty cycle $D = \text{parameter}$, $T_A = 25^\circ\text{C}$

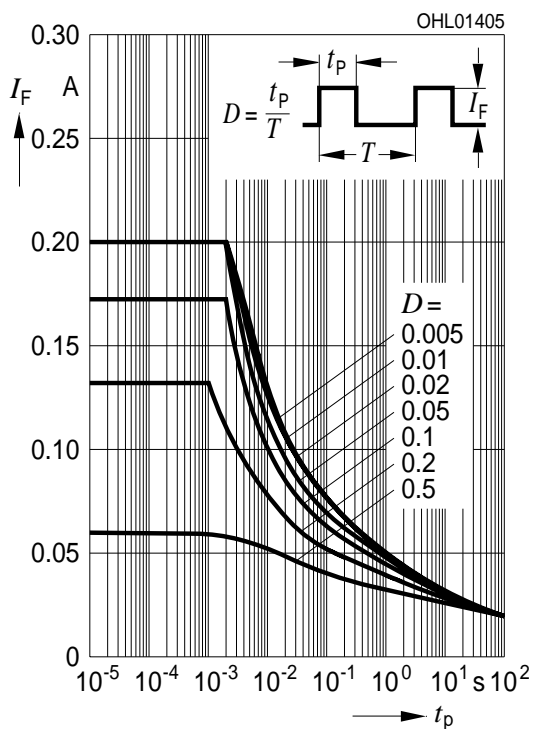

Zulässige Impulsbelastbarkeit $I_F = f(t_p)$
Permissible Pulse Handling Capability
 Duty cycle $D = \text{parameter}$, $T_A = 85^\circ\text{C}$

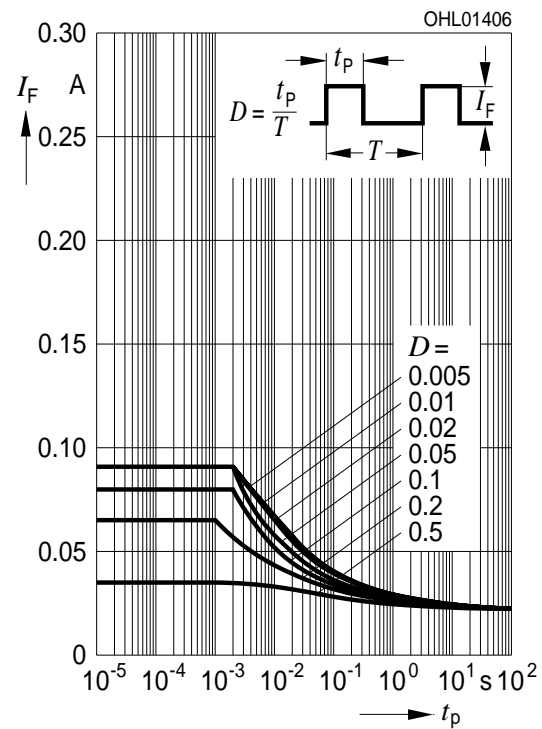

Maßzeichnung Package Outlines

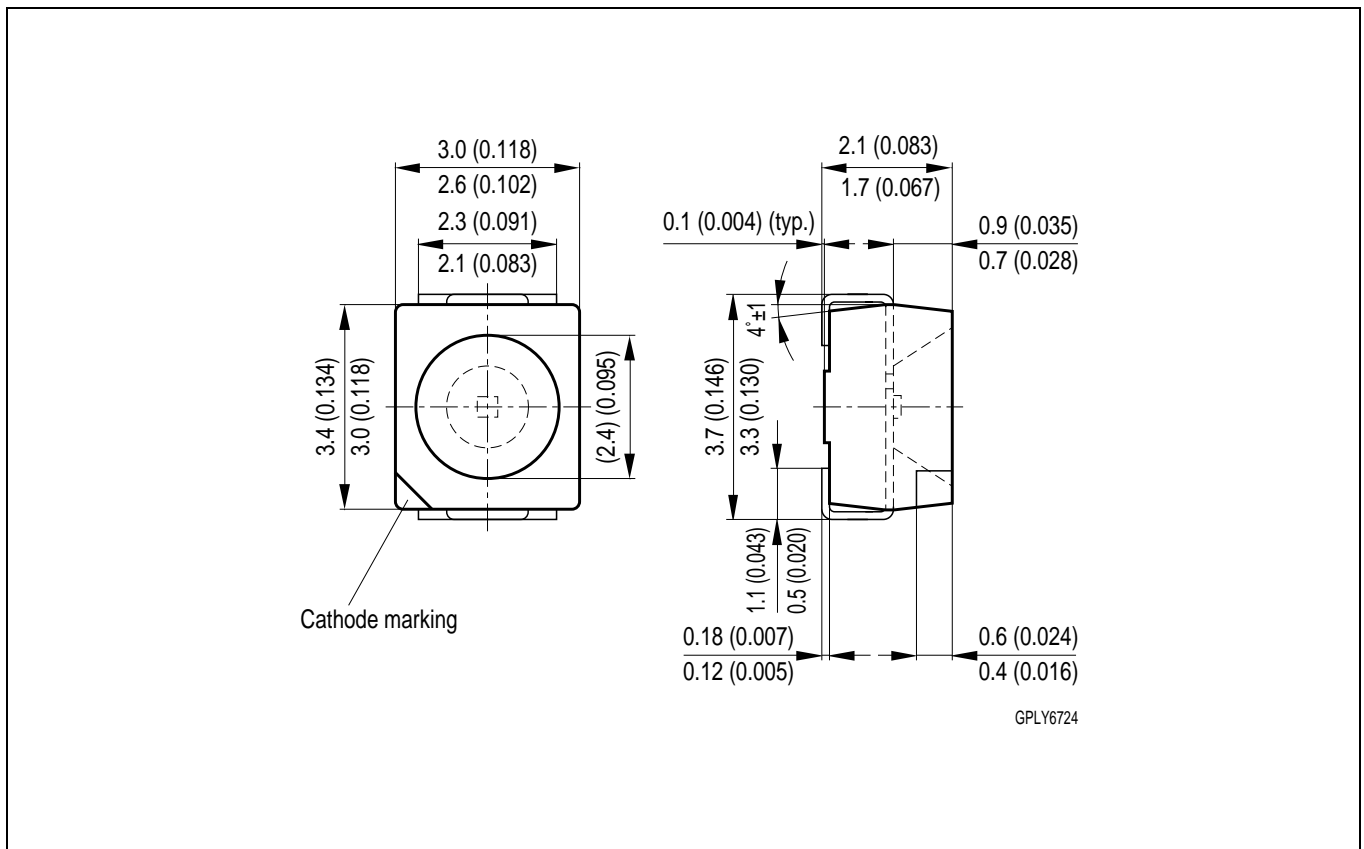

Maße werden wie folgt angegeben: mm (inch) / Dimensions are specified as follows: mm (inch).

Kathodenkennung: abgeschrägte Ecke
Cathode mark: bevelled edge

Lötbedingungen Vorbehandlung nach JEDEC Level 2
Soldering Conditions Preconditioning acc. to JEDEC Level 2

IR-Reflow Lötprofil (nach IPC 9501)
IR Reflow Soldering Profile (acc. to IPC 9501)

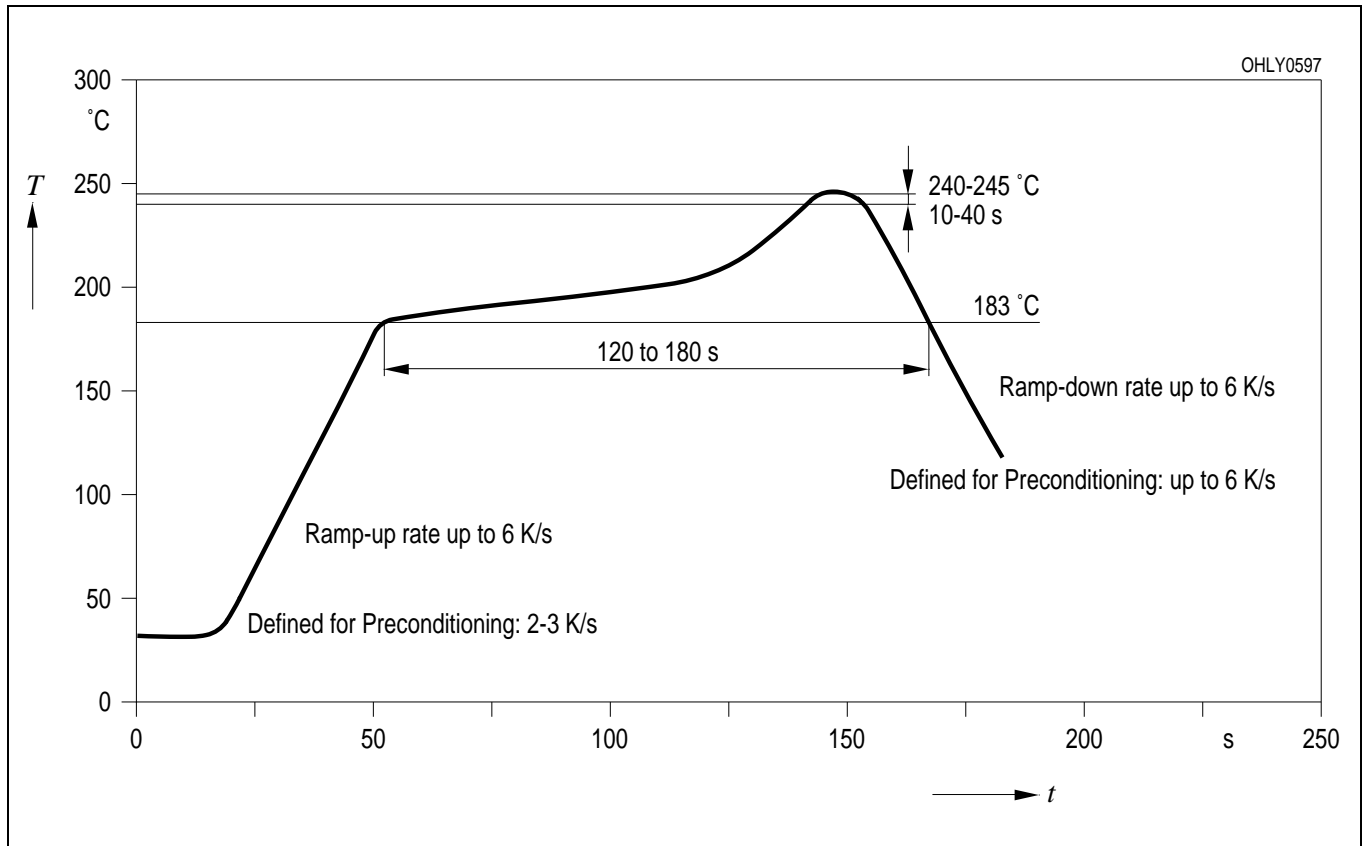

Wellenlötten (TTW) (nach CECC 00802)
TTW Soldering (acc. to CECC 00802)

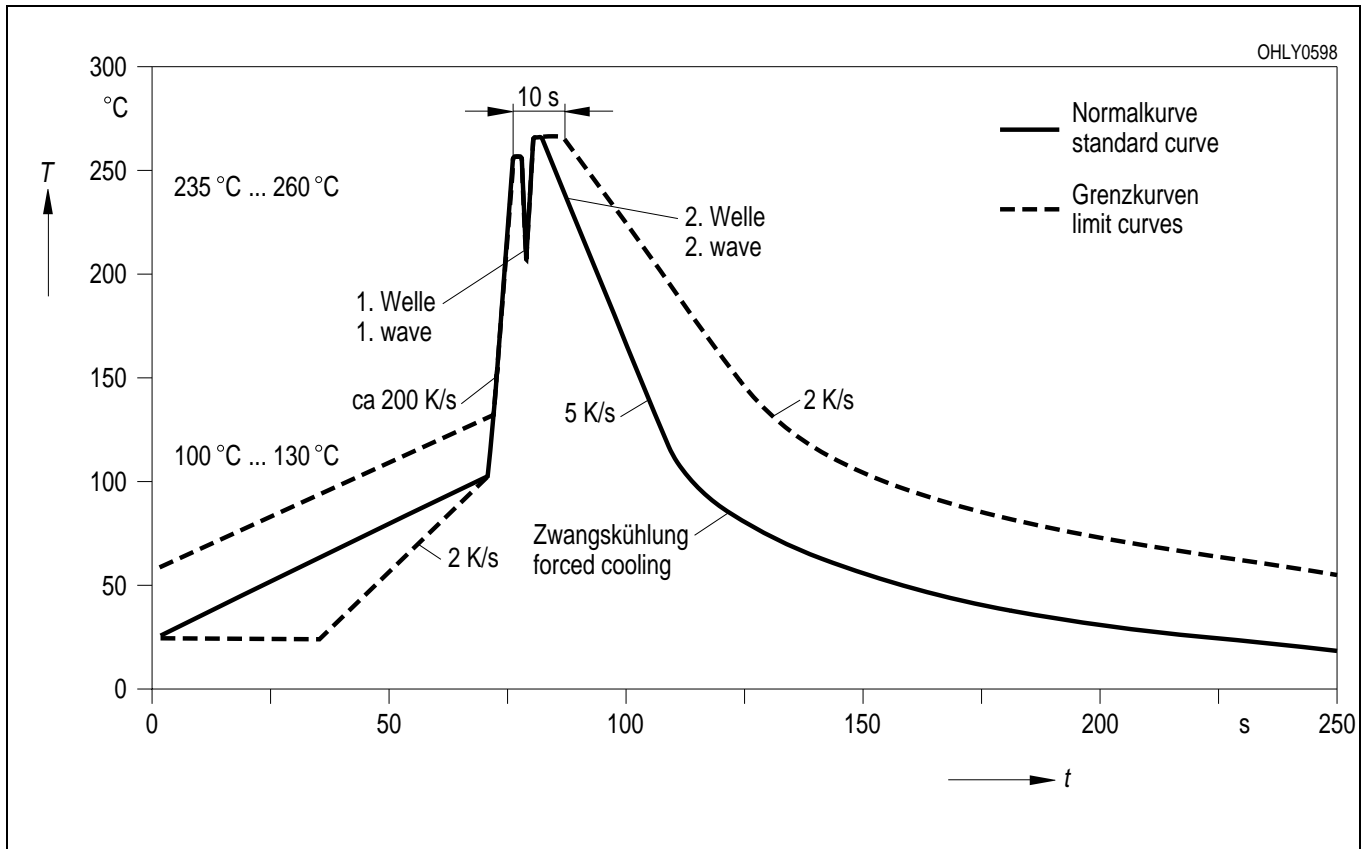

Empfohlenes Lötpadding IR Reflow Löten / Wellenlöten (TTW)
Recommended Solder Pad IR Reflow Soldering / TTW Soldering

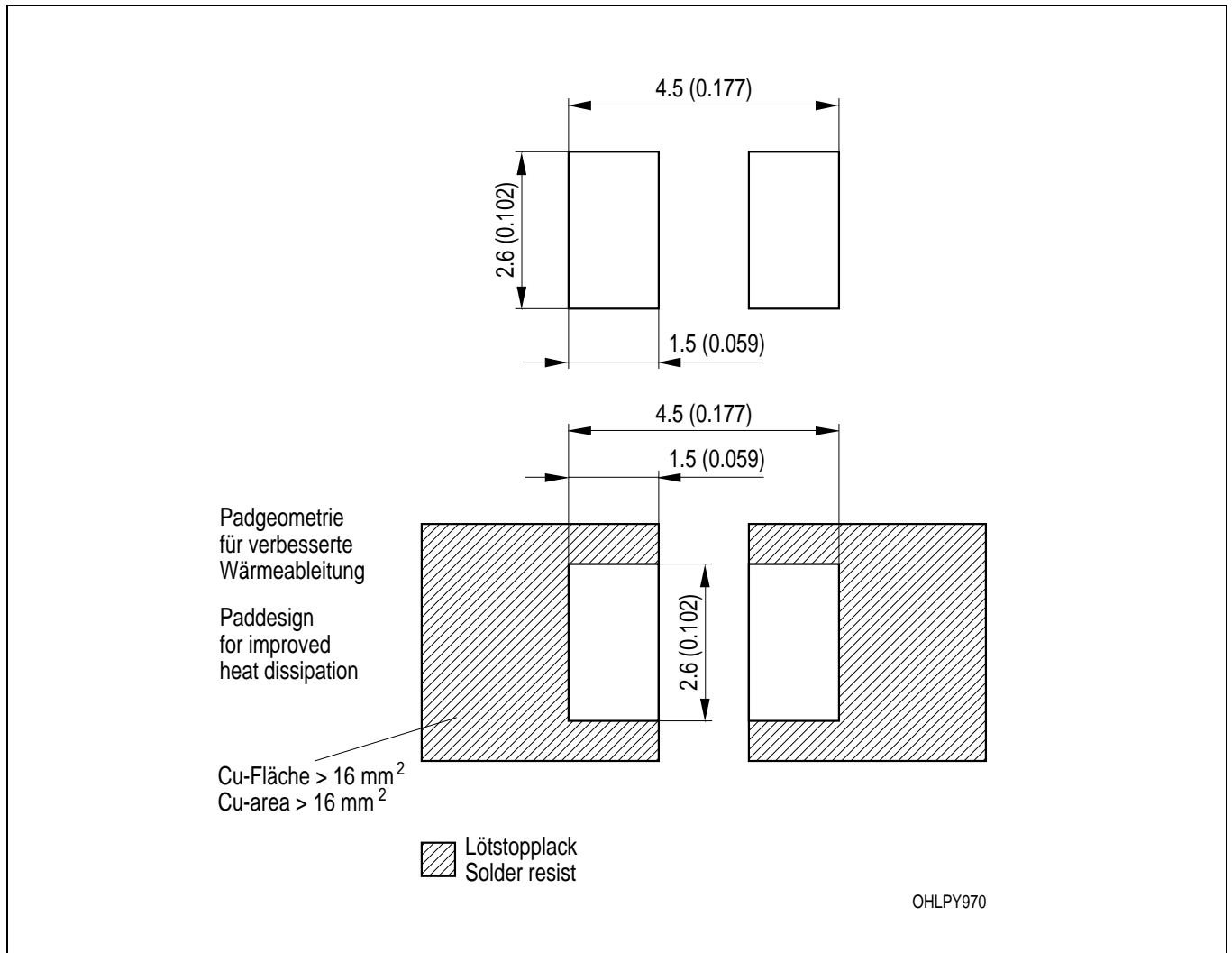

Maße werden wie folgt angegeben: mm (inch) / Dimensions are specified as follows: mm (inch).

Revision History: 2001-01-30

Previous Version: 2001-01-30

Page	Subjects (major changes since last revision)

Patent List

Patent No.

US 6 066 861

Published by OSRAM Opto Semiconductors GmbH & Co. OHG

Wernerwerkstrasse 2, D-93049 Regensburg

© All Rights Reserved.

Attention please!

The information describes the type of component and shall not be considered as assured characteristics.

Terms of delivery and rights to change design reserved. Due to technical requirements components may contain dangerous substances. For information on the types in question please contact our Sales Organization.

Packing

Please use the recycling operators known to you. We can also help you – get in touch with your nearest sales office. By agreement we will take packing material back, if it is sorted. You must bear the costs of transport. For packing material that is returned to us unsorted or which we are not obliged to accept, we shall have to invoice you for any costs incurred.

Components used in life-support devices or systems must be expressly authorized for such purpose! Critical components¹, may only be used in life-support devices or systems² with the express written approval of OSRAM OS.¹ A critical component is a component used in a life-support device or system whose failure can reasonably be expected to cause the failure of that life-support device or system, or to affect its safety or effectiveness of that device or system.² Life support devices or systems are intended (a) to be implanted in the human body, or (b) to support and/or maintain and sustain human life. If they fail, it is reasonable to assume that the health of the user may be endangered.