

IRLR/U3303

HEXFET® Power MOSFET

- Logic-Level Gate Drive
- Ultra Low On-Resistance
- Surface Mount (IRLR3303)
- Straight Lead (IRLU3303)
- Advanced Process Technology
- Fast Switching
- Fully Avalanche Rated

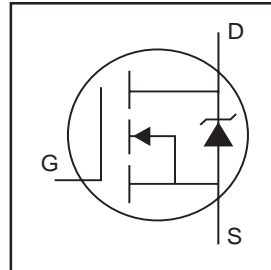

| |
|----------------------------|
| $V_{DSS} = 30V$ |
| $R_{DS(on)} = 0.031\Omega$ |
| $I_D = 35A$ ⑤ |

Description

Fifth Generation HEXFETs from International Rectifier utilize advanced processing techniques to achieve the lowest possible on-resistance per silicon area. This benefit, combined with the fast switching speed and ruggedized device design that HEXFET Power MOSFETs are well known for, provides the designer with an extremely efficient device for use in a wide variety of applications.

The D-PAK is designed for surface mounting using vapor phase, infrared, or wave soldering techniques. The straight lead version (IRFU series) is for through-hole mounting applications. Power dissipation levels up to 1.5 watts are possible in typical surface mount applications.

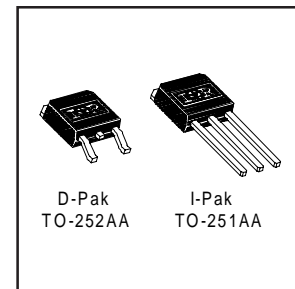

Absolute Maximum Ratings

| | Parameter | Max. | Units |
|---------------------------|--|------------------------|-------|
| $I_D @ T_C = 25^\circ C$ | Continuous Drain Current, $V_{GS} @ 10V$ | 35 ⑤ | A |
| $I_D @ T_C = 100^\circ C$ | Continuous Drain Current, $V_{GS} @ 10V$ | 25 | |
| I_{DM} | Pulsed Drain Current ① | 140 | |
| $P_D @ T_C = 25^\circ C$ | Power Dissipation | 68 | W |
| | Linear Derating Factor | 0.45 | W/°C |
| V_{GS} | Gate-to-Source Voltage | ± 16 | V |
| E_{AS} | Single Pulse Avalanche Energy② | 130 | mJ |
| I_{AR} | Avalanche Current① | 20 | A |
| E_{AR} | Repetitive Avalanche Energy① | 6.8 | mJ |
| dv/dt | Peak Diode Recovery dv/dt ③ | 5.0 | V/ns |
| T_J | Operating Junction and | -55 to + 175 | °C |
| T_{STG} | Storage Temperature Range | | |
| | Soldering Temperature, for 10 seconds | 300 (1.6mm from case) | |

Thermal Resistance

| | Parameter | Typ. | Max. | Units |
|-----------------|-------------------------------|------|------|-------|
| $R_{\theta JC}$ | Junction-to-Case | — | 2.2 | °C/W |
| $R_{\theta JA}$ | Case-to-Ambient (PCB mount)** | — | 50 | |
| $R_{\theta JA}$ | Junction-to-Ambient | — | 110 | |

** When mounted on 1" square PCB (FR-4 or G-10 Material) .

For recommended footprint and soldering techniques refer to application note #AN-994

Electrical Characteristics @ $T_J = 25^\circ\text{C}$ (unless otherwise specified)

| | Parameter | Min. | Typ. | Max. | Units | Conditions |
|---------------------------------|--------------------------------------|------|-------|-------|----------|---|
| $V_{(BR)DSS}$ | Drain-to-Source Breakdown Voltage | 30 | — | — | V | $V_{GS} = 0V, I_D = 250\mu A$ |
| $\Delta V_{(BR)DSS}/\Delta T_J$ | Breakdown Voltage Temp. Coefficient | — | 0.035 | — | V/°C | Reference to $25^\circ\text{C}, I_D = 1\text{mA}$ |
| $R_{DS(on)}$ | Static Drain-to-Source On-Resistance | — | — | 0.031 | Ω | $V_{GS} = 10V, I_D = 21A$ ④ |
| | | — | — | 0.045 | | $V_{GS} = 4.5V, I_D = 17A$ ④ |
| $V_{GS(th)}$ | Gate Threshold Voltage | 1.0 | — | — | V | $V_{DS} = V_{GS}, I_D = 250\mu A$ |
| g_{fs} | Forward Transconductance | 12 | — | — | S | $V_{DS} = 25V, I_D = 20A$ ⑦ |
| I_{DSS} | Drain-to-Source Leakage Current | — | — | 25 | μA | $V_{DS} = 30V, V_{GS} = 0V$ |
| | | — | — | 250 | | $V_{DS} = 24V, V_{GS} = 0V, T_J = 150^\circ\text{C}$ |
| I_{GSS} | Gate-to-Source Forward Leakage | — | — | 100 | nA | $V_{GS} = 16V$ |
| | Gate-to-Source Reverse Leakage | — | — | -100 | | $V_{GS} = -16V$ |
| Q_g | Total Gate Charge | — | — | 26 | nC | $I_D = 20A$ |
| Q_{gs} | Gate-to-Source Charge | — | — | 8.8 | | $V_{DS} = 24V$ |
| Q_{gd} | Gate-to-Drain ("Miller") Charge | — | — | 15 | | $V_{GS} = 4.5V$, See Fig. 6 and 13 ④ ⑦ |
| $t_{d(on)}$ | Turn-On Delay Time | — | 7.4 | — | ns | $V_{DD} = 15V$ |
| t_r | Rise Time | — | 200 | — | | $I_D = 20A$ |
| $t_{d(off)}$ | Turn-Off Delay Time | — | 14 | — | | $R_G = 6.5\Omega, V_{GS} = 4.5V$ |
| t_f | Fall Time | — | 36 | — | | $R_D = 0.70\Omega$, See Fig. 10 ④ ⑦ |
| L_D | Internal Drain Inductance | — | 4.5 | — | nH | Between lead, 6mm (0.25in.) from package and center of die contact ⑥ |
| L_S | Internal Source Inductance | — | 7.5 | — | | |
| C_{ISS} | Input Capacitance | — | 870 | — | pF | $V_{GS} = 0V$ |
| C_{OSS} | Output Capacitance | — | 340 | — | | $V_{DS} = 25V$ |
| C_{RSS} | Reverse Transfer Capacitance | — | 170 | — | | $f = 1.0\text{MHz}$, See Fig. 5 ⑦ |

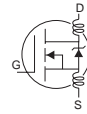

Source-Drain Ratings and Characteristics

| | Parameter | Min. | Typ. | Max. | Units | Conditions |
|----------|---|---|------|------|-------|---|
| I_S | Continuous Source Current (Body Diode) | — | — | 35 | A | MOSFET symbol showing the integral reverse p-n junction diode. |
| I_{SM} | Pulsed Source Current (Body Diode) ① | — | — | 140 | | |
| V_{SD} | Diode Forward Voltage | — | — | 1.3 | V | $T_J = 25^\circ\text{C}, I_S = 20A, V_{GS} = 0V$ ④ |
| t_{rr} | Reverse Recovery Time | — | 72 | 110 | ns | $T_J = 25^\circ\text{C}, I_F = 20A$ |
| Q_{rr} | Reverse Recovery Charge | — | 180 | 280 | nC | $di/dt = 100A/\mu s$ ④ ⑦ |
| t_{on} | Forward Turn-On Time | Intrinsic turn-on time is negligible (turn-on is dominated by $L_S + L_D$) | | | | |

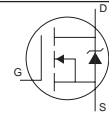

Notes:

- ① Repetitive rating; pulse width limited by max. junction temperature. (See fig. 11)
- ② $V_{DD} = 15V$, starting $T_J = 25^\circ\text{C}$, $L = 470\mu H$
 $R_G = 25\Omega, I_{AS} = 20A$. (See Figure 12)
- ③ $I_{SD} \leq 20A, di/dt \leq 140A/\mu s, V_{DD} \leq V_{(BR)DSS}, T_J \leq 175^\circ\text{C}$
- ④ Pulse width $\leq 300\mu s$; duty cycle $\leq 2\%$.

- ⑤ Calculated continuous current based on maximum allowable junction temperature; Package limitation current = 20A.
- ⑥ This is applied for I-PAK, L_S of D-PAK is measured between lead and center of die contact.
- ⑦ Uses IRL3303 data and test conditions.

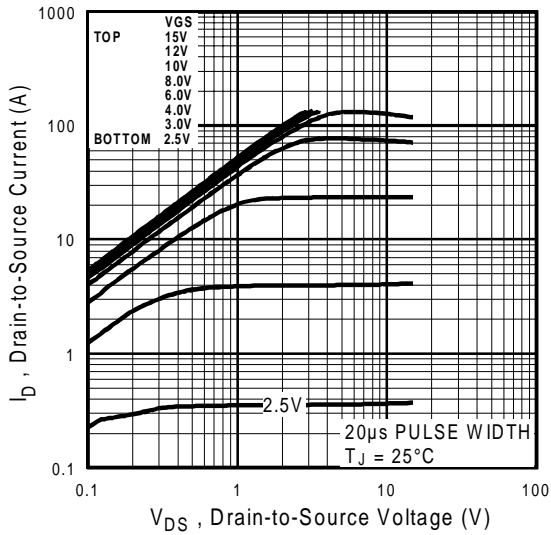

Fig 1. Typical Output Characteristics

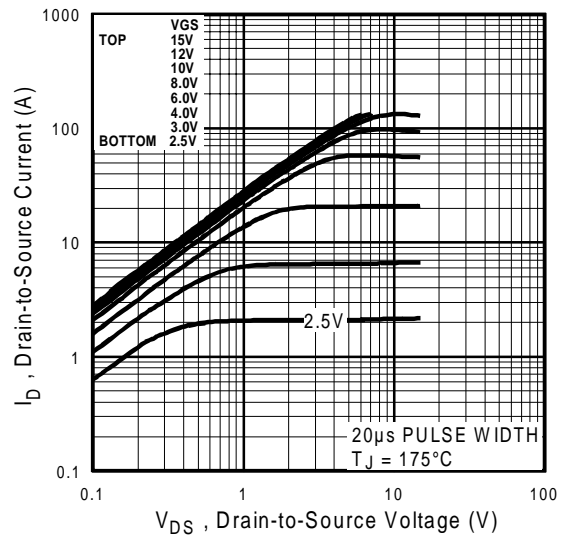

Fig 2. Typical Output Characteristics

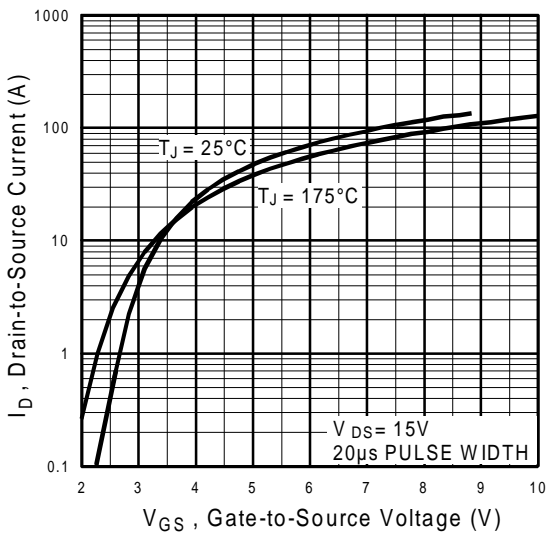

Fig 3. Typical Transfer Characteristics

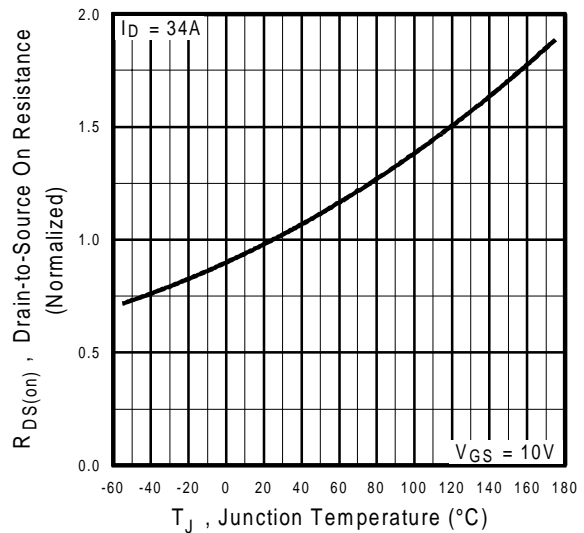

Fig 4. Normalized On-Resistance Vs. Temperature

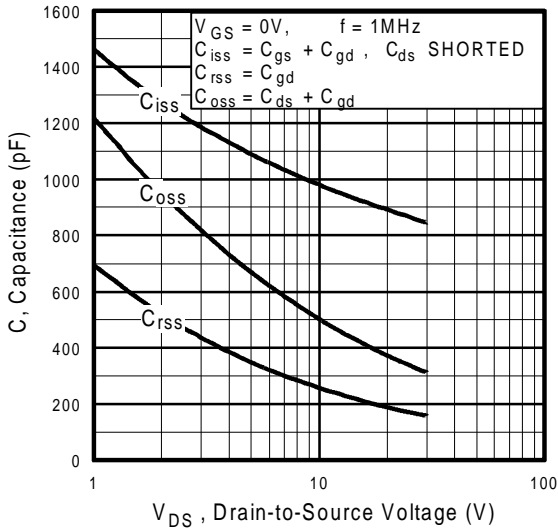

Fig 5. Typical Capacitance Vs. Drain-to-Source Voltage

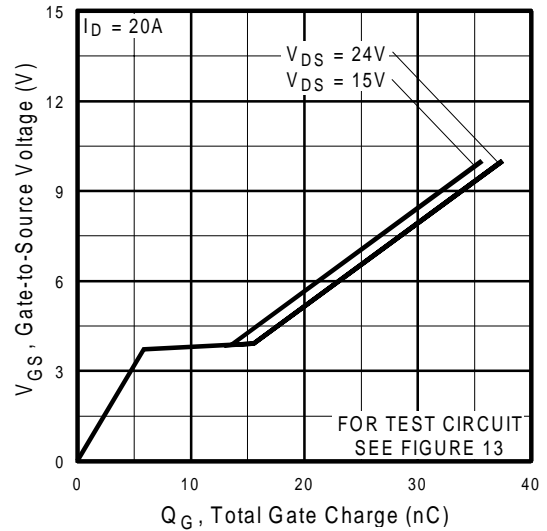

Fig 6. Typical Gate Charge Vs. Gate-to-Source Voltage

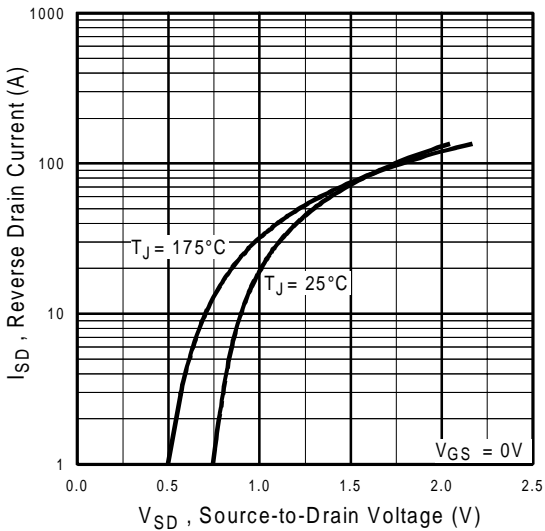

Fig 7. Typical Source-Drain Diode Forward Voltage

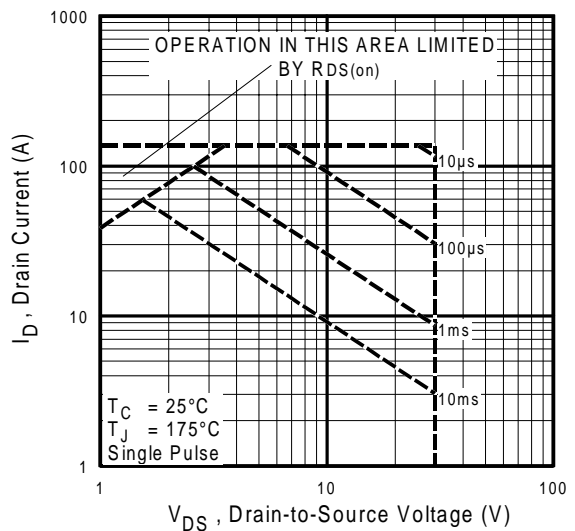

Fig 8. Maximum Safe Operating Area

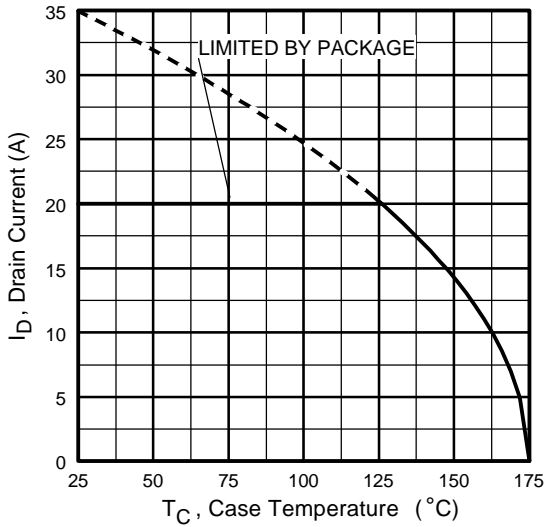

Fig 9. Maximum Drain Current Vs. Case Temperature

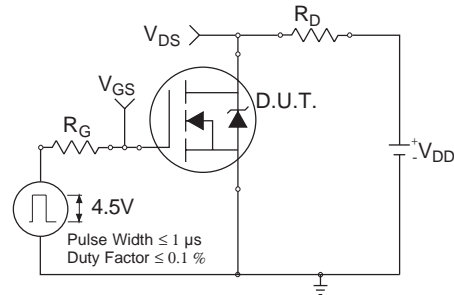

Fig 10a. Switching Time Test Circuit



Fig 10b. Switching Time Waveforms

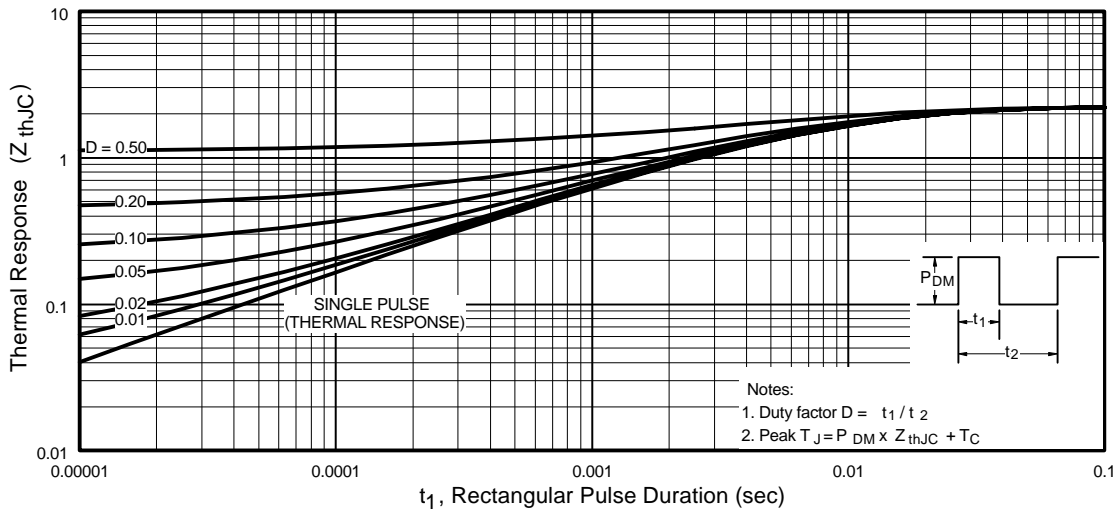

Fig 11. Maximum Effective Transient Thermal Impedance, Junction-to-Case

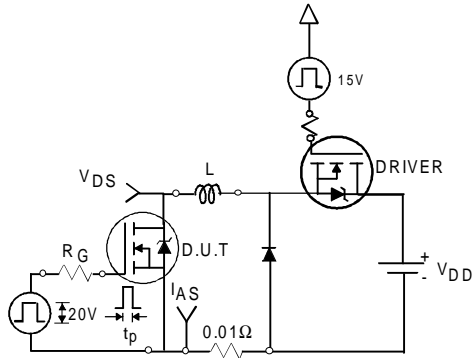

Fig 12a. Unclamped Inductive Test Circuit

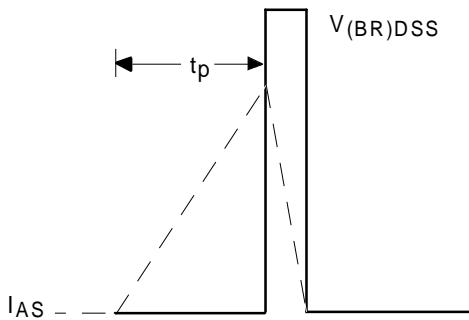

Fig 12b. Unclamped Inductive Waveforms

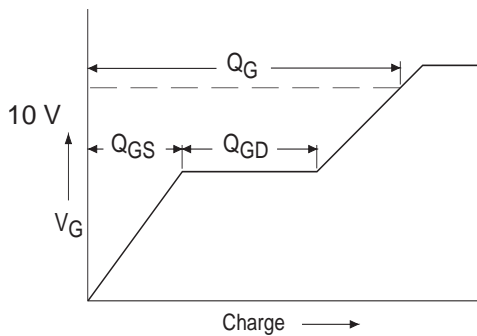

Fig 13a. Basic Gate Charge Waveform

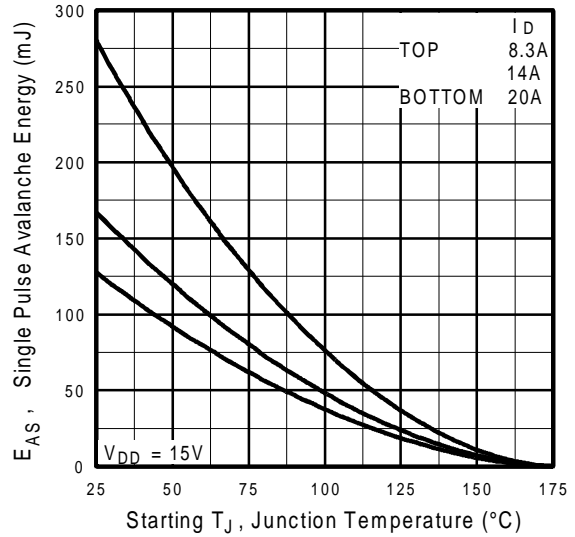

Fig 12c. Maximum Avalanche Energy Vs. Drain Current

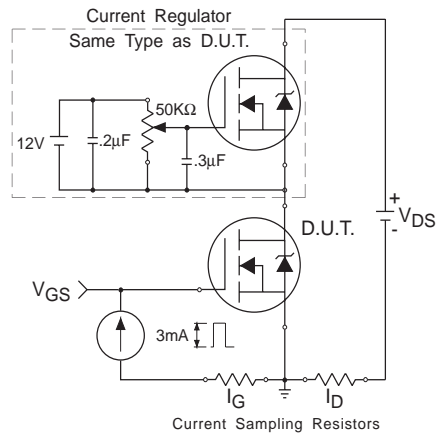

Fig 13b. Gate Charge Test Circuit

Peak Diode Recovery dv/dt Test Circuit



* $V_{GS} = 5V$ for Logic Level Devices

Fig 14. For N-Channel HEXFETS

IRLR/U3303



Package Outline

TO-252AA Outline

Dimensions are shown in millimeters (inches)

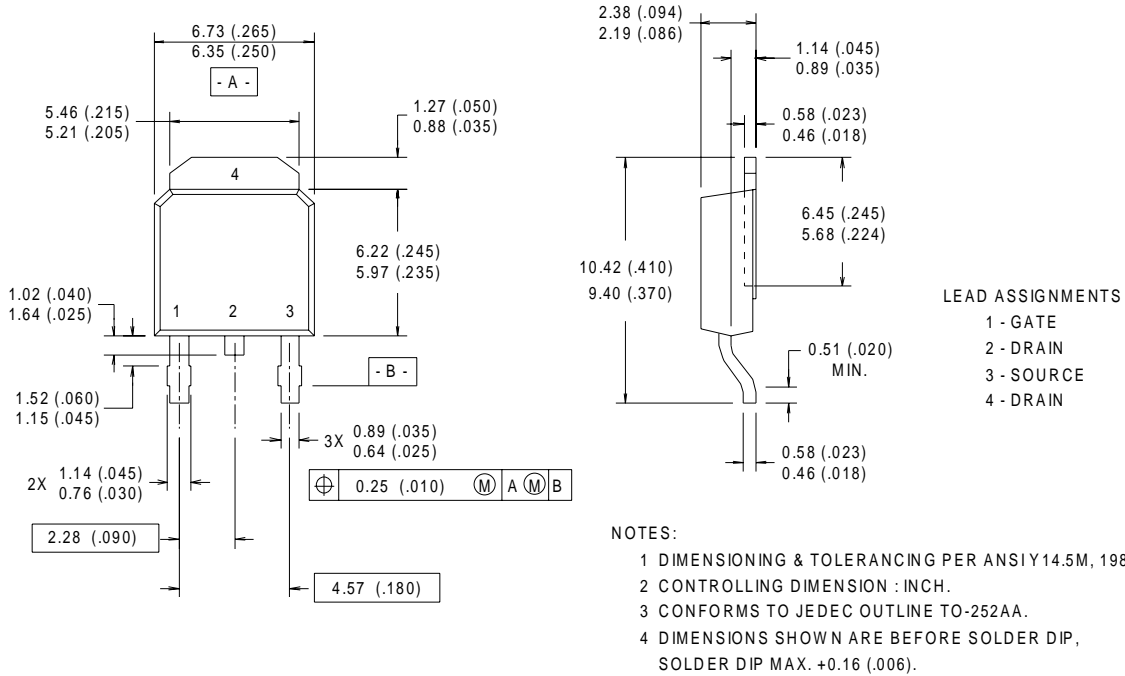

Part Marking Information

TO-252AA (D-PARK)

EXAMPLE : THIS IS AN IRFR120
WITH ASSEMBLY
LOT CODE 9U1P

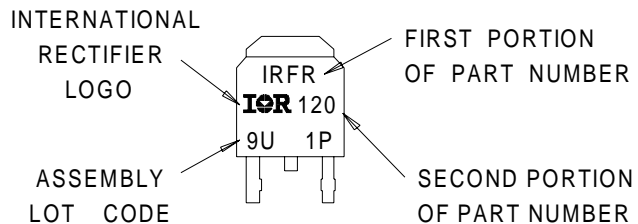

Package Outline

TO-251AA Outline

Dimensions are shown in millimeters (inches)

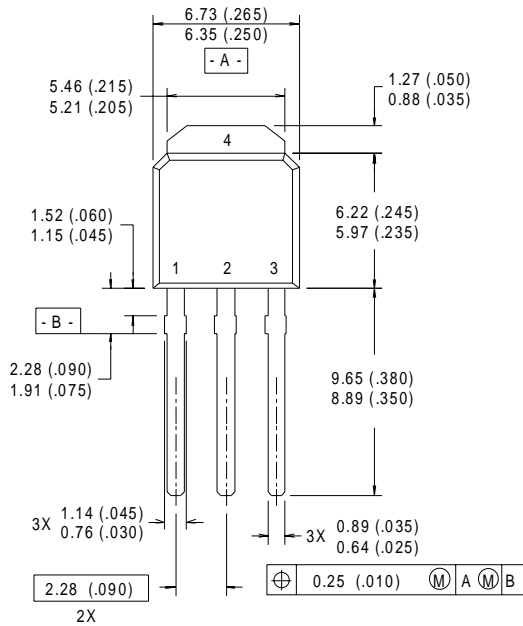

LEAD ASSIGNMENTS

- 1 - GATE
- 2 - DRAIN
- 3 - SOURCE
- 4 - DRAIN

NOTES:

- 1 DIMENSIONING & TOLERANCING PER ANSI Y14.5M, 1982.
- 2 CONTROLLING DIMENSION : INCH.
- 3 CONFORMS TO JEDEC OUTLINE TO-252AA.
- 4 DIMENSIONS SHOWN ARE BEFORE SOLDER DIP, SOLDER DIP MAX. +0.16 (.006).

Part Marking Information

TO-251AA (I-PARK)

EXAMPLE : THIS IS AN IRFU120
 WITH ASSEMBLY
 LOT CODE 9U1P

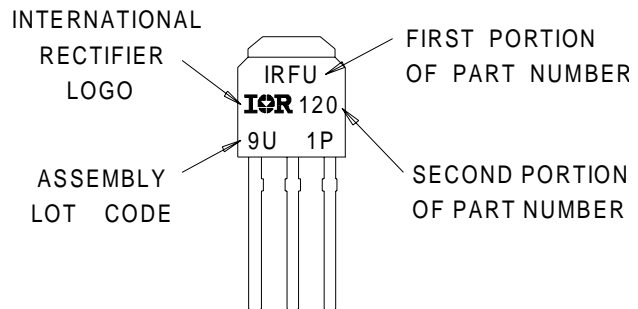

IRLR/U3303

International
IR Rectifier

Tape & Reel Information

TO-252AA

Dimensions are shown in millimeters (inches)

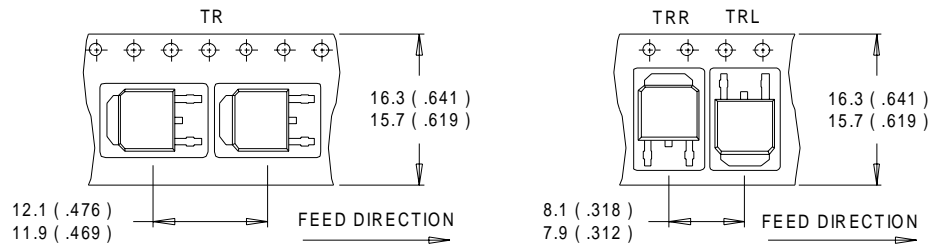

NOTES :

1. CONTROLLING DIMENSION : MILLIMETER.
2. ALL DIMENSIONS ARE SHOWN IN MILLIMETERS (INCHES).
3. OUTLINE CONFORMS TO EIA-481 & EIA-541.

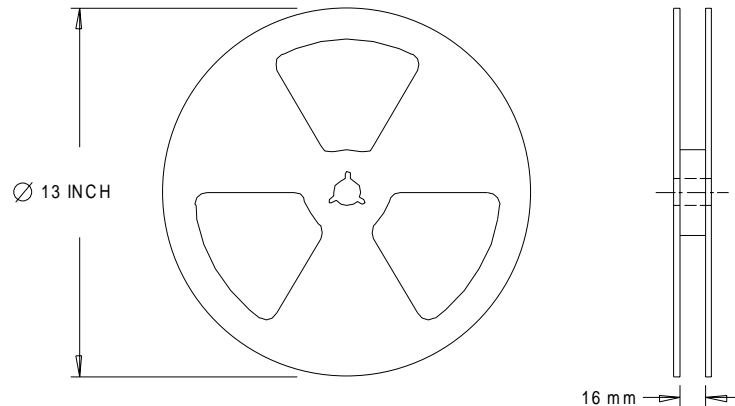

NOTES :

1. OUTLINE CONFORMS TO EIA-481.

International
IR Rectifier

WORLD HEADQUARTERS: 233 Kansas St., El Segundo, California 90245, Tel: (310) 322 3331

IR GREAT BRITAIN: Hurst Green, Oxted, Surrey RH8 9BB, UK Tel: ++ 44 1883 732020

IR CANADA: 15 Lincoln Court, Brampton, Ontario L6T3Z2, Tel: (905) 453 2200

IR GERMANY: Saalburgstrasse 157, 61350 Bad Homburg Tel: ++ 49 6172 96590

IR ITALY: Via Liguria 49, 10071 Borgaro, Torino Tel: ++ 39 11 451 0111

IR FAR EAST: K&H Bldg., 2F, 30-4 Nishi-Ikebukuro 3-Chome, Toshima-Ku, Tokyo Japan 171 Tel: 81 3 3983 0086

IR SOUTHEAST ASIA: 1 Kim Seng Promenade, Great World City West Tower, 13-11, Singapore 237994 Tel: ++ 65 838 4630

IR TAIWAN: 16 Fl. Suite D. 207, Sec. 2, Tun Haw South Road, Taipei, 10673, Taiwan Tel: 886-2-2377-9936

<http://www.irf.com/> Data and specifications subject to change without notice. 9/98