

General Purpose Transistor

PNP Silicon

- Pb-Free Package May be Available. The G-Suffix Denotes a Pb-Free Lead Finish

LMBT2907LT1
LMBT2907ALT1

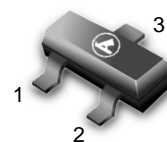

SOT-23

MAXIMUM RATINGS

Rating	Symbol	Value		Unit
		2907	2907A	
Collector-Emitter Voltage	V_{CEO}	-40	-60	Vdc
Collector-Base Voltage	V_{CBO}		-60	Vdc
Emitter-Base Voltage	V_{EBO}		-5.0	Vdc
Collector Current — Continuous	I_C		-600	mAdc

THERMAL CHARACTERISTICS

Characteristic	Symbol	Max	Unit
Total Device Dissipation FR-5 Board, (1) $T_A = 25^\circ\text{C}$	P_D	225	mW
Derate above 25°C		1.8	mW/ $^\circ\text{C}$
Thermal Resistance, Junction to Ambient	$R_{\theta JA}$	556	$^\circ\text{C}/\text{W}$
Total Device Dissipation Alumina Substrate, (2) $T_A = 25^\circ\text{C}$	P_D	300	mW
Derate above 25°C		2.4	mW/ $^\circ\text{C}$
Thermal Resistance, Junction to Ambient	$R_{\theta JA}$	417	$^\circ\text{C}/\text{W}$
Junction and Storage Temperature	T_J, T_{stg}	-55 to +150	$^\circ\text{C}$

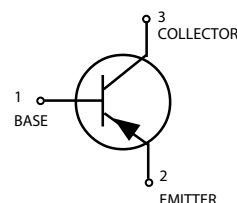

ORDERING INFORMATION

Device	Package	Shipping
LMBT2907LT1	SOT-23	3000/Tape & Reel
LMBT2907LT1G	SOT-23	3000/Tape & Reel
LMBT2907ALT1	SOT-23	3000/Tape & Reel
LMBT2907ALT1G	SOT-23	3000/Tape & Reel

DEVICE MARKING

LMBT2907LT1 = M2B, LMBT2907ALT1 = 2F

ELECTRICAL CHARACTERISTICS ($T_A = 25^\circ\text{C}$ unless otherwise noted.)

Characteristic	Symbol	Min	Max	Unit
----------------	--------	-----	-----	------

OFF CHARACTERISTICS

Collector-Emitter Breakdown Voltage(3) ($I_C = -10\text{ mAdc}, I_E = 0$)	$V_{(BR)CEO}$			Vdc
	LMBT2907	-40	—	
	LMBT2907A	-60	—	
Collector-Emitter Breakdown Voltage($I_C = -10\ \mu\text{Adc}, I_E = 0$)	$V_{(BR)CBO}$	-60	—	Vdc
Emitter-Base Breakdown Voltage($I_E = -10\ \mu\text{Adc}, I_C = 0$)	$V_{(BR)EBO}$	-5.0	—	Vdc
Collector Cutoff Current($V_{CB} = -30\text{Vdc}, I_{BE(OFF)} = -0.5\text{Vdc}$)	I_{CEX}	—	-50	nAdc
Collector Cutoff Current ($V_{CB} = -50\text{Vdc}, I_E = 0$)	I_{CBO}			μAdc
	LMBT2907	—	-0.020	
	LMBT2907A	—	-0.010	
($V_{CB} = -50\text{Vdc}, I_E = 0, T_A = 125^\circ\text{C}$)	LMBT2907	—	-20	
	LMBT2907A	—	-10	
Base Current($V_{CE} = -30\text{Vdc}, V_{EB(OFF)} = -0.5\text{Vdc}$)	I_B	—	-50	nAdc

1. FR-5 = 1.0 x 0.75 x 0.062 in.

2. Alumina = 0.4 x 0.3 x 0.024 in. 99.5% alumina.

3. Pulse Test: Pulse Width $\leq 300\ \mu\text{s}$, Duty Cycle $\leq 2.0\%$.

LMBT2907LT1 LMBT2907ALT1

ELECTRICAL CHARACTERISTICS ($T_A = 25^\circ\text{C}$ unless otherwise noted) (Continued)

Characteristic	Symbol	Min	Max	Unit
ON CHARACTERISTICS				
DC Current Gain ($I_C = -0.1\text{mA}$, $V_{CE} = -10\text{Vdc}$)	h_{FE}	35	—	—
	LMBT2907	75	—	—
	LMBT2907A	—	—	—
($I_C = -1.0\text{mA}$, $V_{CE} = -10\text{Vdc}$)	LMBT2907	50	—	—
	LMBT2907A	100	—	—
($I_C = -10\text{mA}$, $V_{CE} = -10\text{Vdc}$)	LMBT2907	75	—	—
	LMBT2907A	100	—	—
($I_C = -150\text{mA}$, $V_{CE} = -10\text{Vdc}$)(3)	LMBT2907	—	—	—
	LMBT2907A	100	300	—
($I_C = -500\text{mA}$, $V_{CE} = -10\text{Vdc}$)(3)	LMBT2907	30	—	—
	LMBT2907A	50	—	—
Collector–Emitter Saturation Voltage(3) ($I_C = -150\text{mA}$, $I_B = -15\text{mA}$) ($I_C = -500\text{mA}$, $I_B = -50\text{mA}$)	$V_{CE(sat)}$	—	-0.4 -1.6	Vdc
Base–Emitter Saturation Voltage(3) ($I_C = -150\text{mA}$, $I_B = -15\text{mA}$) ($I_C = -500\text{mA}$, $I_B = -50\text{mA}$)	$V_{BE(sat)}$	—	-1.3 -2.6	Vdc

SMALL-SIGNAL CHARACTERISTICS

Current–Gain — Bandwidth Product(3),(4) ($I_C = -50\text{mA}$, $V_{CE} = -20\text{Vdc}$, $f = 100\text{MHz}$)	f_T	200	—	MHz
Output Capacitance ($V_{CB} = -10\text{Vdc}$, $I_E = 0$, $f = 1.0\text{MHz}$)	C_{obo}	—	8.0	pF
Input Capacitance ($V_{EB} = -2.0\text{Vdc}$, $I_C = 0$, $f = 1.0\text{MHz}$)	C_{ibo}	—	30	pF

SWITCHING CHARACTERISTICS

Turn–On Time Delay Time Rise Time	($V_{CC} = -30\text{Vdc}$, $I_C = -150\text{mA}$, $I_{B1} = -15\text{mA}$)	t_{on} t^d t_r	— — —	45 10 40	ns
Fall Time Storage Time Turn–Off Time	($V_{CC} = -6.0\text{Vdc}$, $I_C = -150\text{mA}$, $I_{B1} = I_{B2} = 15\text{mA}$)	t_f t_s t_{off}	— — —	30 80 100	ns

3. Pulse Test: Pulse Width $\leq 300\ \mu\text{s}$, Duty Cycle $\leq 2.0\%$.

4. f_T is defined as the frequency at which $|h_{fe}|$ extrapolates to unity.

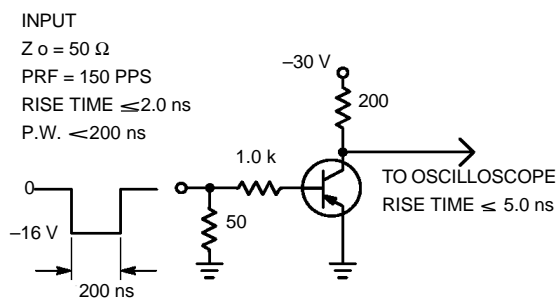

Figure 1. Delay and Rise Time Test Circuit

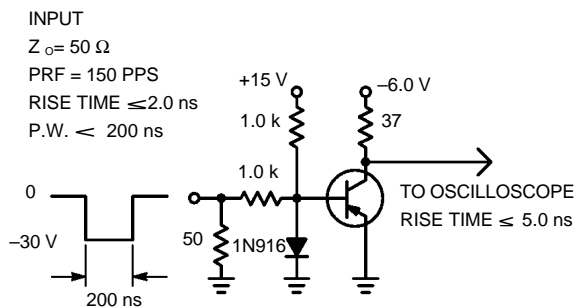

Figure 2. Storage and Fall Time Test Circuit

LMBT2907LT1 LMBT2907ALT1

TYPICAL CHARACTERISTICS

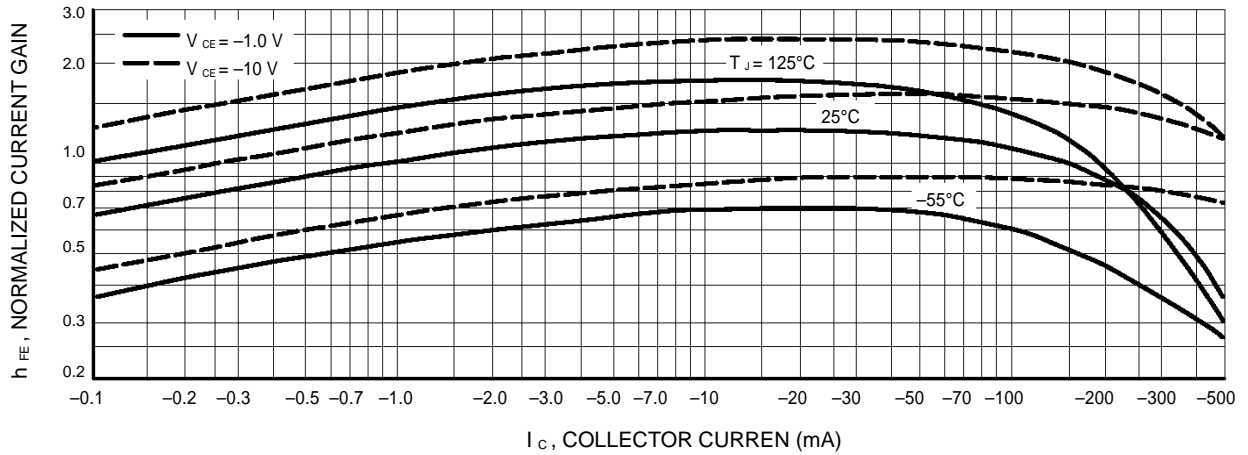

Figure 3. DC Current Gain

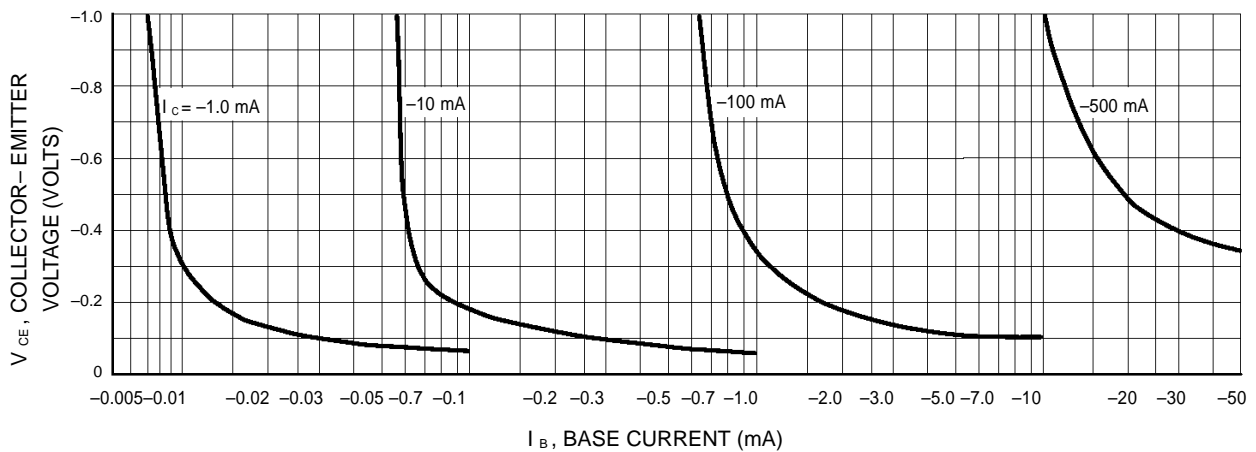

Figure 4. Collector Saturation Region

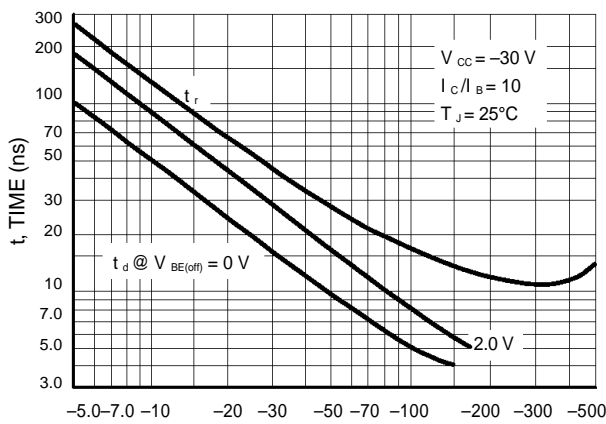

Figure 5. Turn-On Time

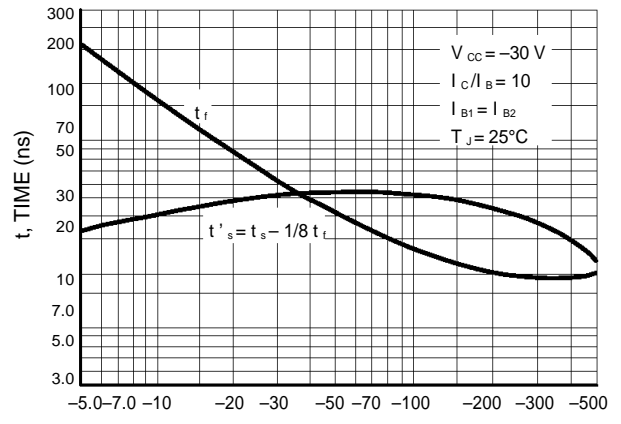

Figure 6. Turn-Off Time

LMBT2907LT1 LMBT2907ALT1

TYPICAL SMALL-SIGNAL CHARACTERISTICS

NOISE FIGURE

$V_{CE} = 10 \text{ Vdc}$, $T_A = 25^\circ\text{C}$

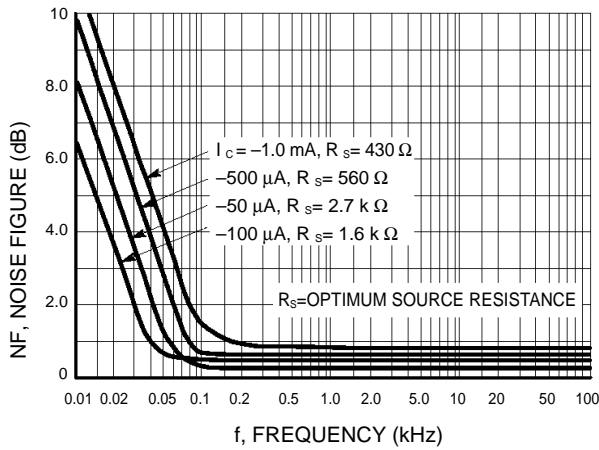

Figure 7. Frequency Effects

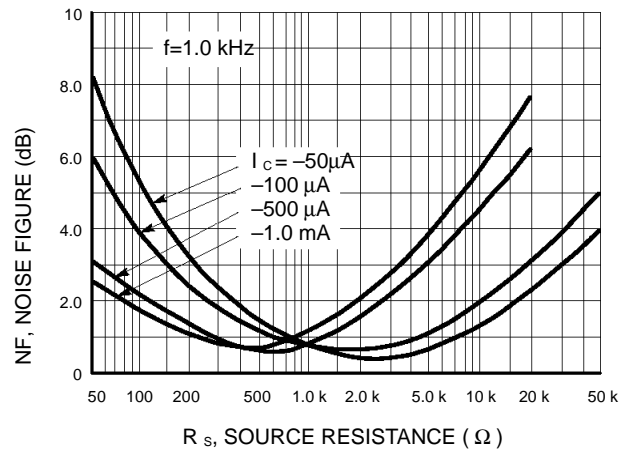

Figure 8. Source Resistance Effects

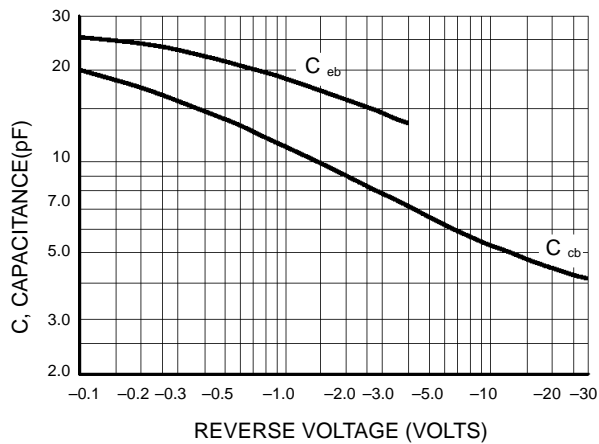

Figure 9. Capacitances

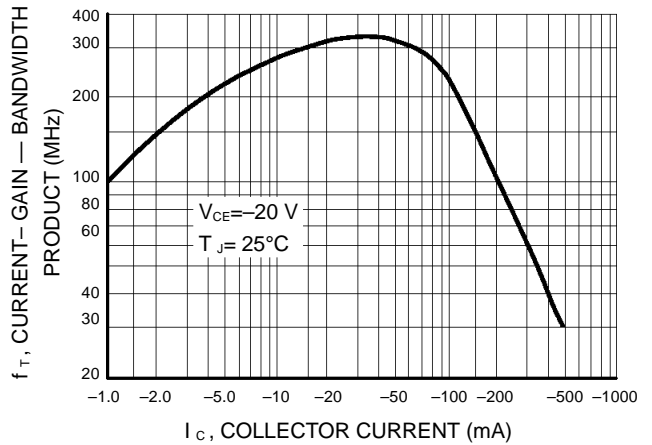

Figure 10. Current-Gain — Bandwidth Product

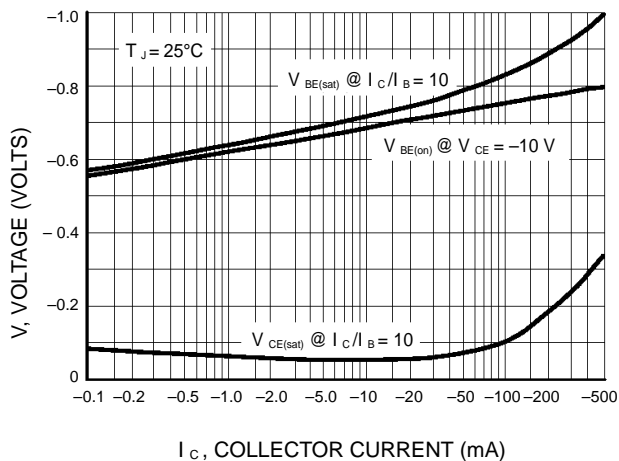

Figure 11. "On" Voltage

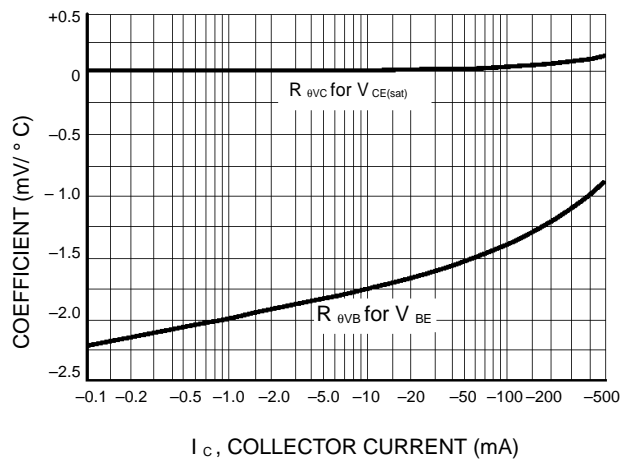
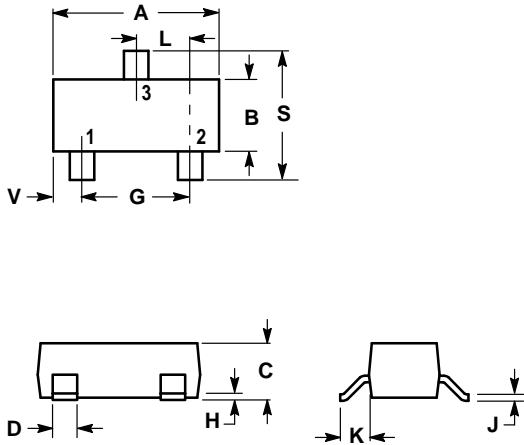

Figure 12. Temperature Coefficients

LMBT2907LT1 LMBT2907ALT1

SOT-23



NOTES:

1. DIMENSIONING AND TOLERANCING PER ANSI Y14.5M, 1982.
2. CONTROLLING DIMENSION: INCH.

DIM	INCHES		MILLIMETERS	
	MIN	MAX	MIN	MAX
A	0.1102	0.1197	2.80	3.04
B	0.0472	0.0551	1.20	1.40
C	0.0350	0.0440	0.89	1.11
D	0.0150	0.0200	0.37	0.50
G	0.0701	0.0807	1.78	2.04
H	0.0005	0.0040	0.013	0.100
J	0.0034	0.0070	0.085	0.177
K	0.0140	0.0285	0.35	0.69
L	0.0350	0.0401	0.89	1.02
S	0.0830	0.1039	2.10	2.64
V	0.0177	0.0236	0.45	0.60

- PIN 1. BASE
 2. EMITTER
 3. COLLECTOR

