

Features

- UNII, Hiperlan, and 802.11a Applications
- Low Insertion Loss: 1.0 dB Typical
- High Isolation: 21 dB Typical
- Low Leakage Current: $< 1 \mu\text{A}$
- Fast Switching Speed
- 4 mm FQFP-N Plastic Surface Mount Package

Description

The MASWSM0002 is a low loss RF switch mounted in a standard outline 4 mm, 16 pin FQFP-N leadless plastic package. It is designed for U-NII, Hiperlan, and 802.11a applications. The MASWSM0002 features isolation greater than 20 dB, a P1dB point above 30 dBm, and switching speeds of 15 ns typical. Its small size and height make it ideal for PC card and access point applications.

The MASWSM0002 is fabricated using M/A-COM's 0.5 micron P-HEMT process to realize low loss and high linearity. The process features passivation for increased performance and reliability.

Ordering Information

Part Number	Description
MASWSM0002TR	7 inch, 1000 piece reel
MASWSM0002TR-3000	13 inch, 3000 piece reel
MASWSM0002SMB	Sample Test Board

Functional Schematic

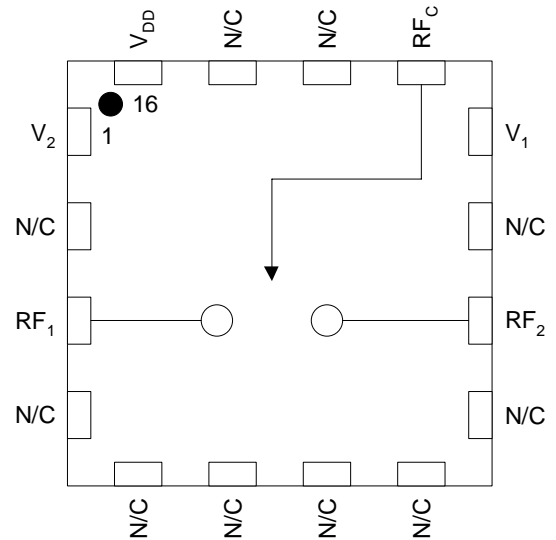

Pin Configuration

Pin	Function	Description
1	V_2	Voltage Control Line 2
2	N/C	Not Connected
3	RF_1	RF Port 1
4	N/C	Not Connected
5	N/C	Not Connected
6	N/C	Not Connected
7	N/C	Not Connected
8	N/C	Not Connected
9	N/C	Not Connected
10	RF_2	RF Port 2
11	N/C	Not Connected
12	V_1	Voltage Control Line 1
13	RF_C	Common RF Port
14	N/C	Not Connected
15	N/C	Not Connected
16	V_{DD}	DC Supply Voltage
Pad	GND	RF & DC Ground

Specifications subject to change without notice.

- North America: Tel. (800) 366-2266
- Asia/Pacific: Tel.+81-44-844-8296, Fax +81-44-844-8298
- Europe: Tel. +44 (1344) 869 595, Fax+44 (1344) 300 020

Visit www.macom.com for additional data sheets and product information.

Electrical Specifications: $T_A = 25\text{ }^\circ\text{C}$, $Z_0 = 50\ \Omega$ ¹

Characteristic	Test Conditions	Unit	Min	Typ	Max
Frequency		GHz	5.15		5.35
Insertion Loss	$F = 5.25\text{ GHz}$, $P_{IN} = 0\text{ dBm}$	dB		1.0	1.4
Isolation	$F = 5.25\text{ GHz}$, $P_{IN} = 0\text{ dBm}$	dB	18	21	
Return Loss, RF_C	$F = 5.25\text{ GHz}$, $P_{IN} = 0\text{ dBm}$	dB		13	
1 dB Compression Point	$F = 5.25\text{ GHz}$	dBm		30.5	
Third Order Intercept Point	$F = 5.250\text{ GHz}$, $P_{IN} = +20\text{ dBm}$ $F = 5.251\text{ GHz}$, $P_{IN} = +20\text{ dBm}$	dBm		51	
Leakage Current	$F = 5.25\text{ GHz}$, $P_{IN} = +20\text{ dBm}$	μA		1.0	
T_{RISE} , T_{FALL}	10% to 90% RF, 90% to 10% RF	ns		8	
T_{ON} , T_{OFF}	50% Control to 90% RF, 50% Control to 10% RF	ns		15	

- Control voltages are 0 V and +3 V, and V_{DD} is +3 V unless otherwise specified.

Switch Logic Table^{1,2}

Insertion Loss Path	Isolated Path	V_1	V_2
RF_1/RF_C	RF_2/RF_C	1	0
RF_2/RF_C	RF_1/RF_C	0	1

- "0" = 0 +/- 0.2 volts
- "1" = +2.7 to +5 volts, equal to V_{DD}

Absolute Maximum Ratings¹

Parameter	Absolute Maximum
Max Input Power	+ 33 dBm
Operating Voltage	+5.5 volts
Operating Temperature	-40 °C to +100 °C
Channel Temperature	+150 °C
Storage Temperature	-40 °C to +150 °C

- Exceeding any one or combination of these limits may cause permanent damage.

Application Information

Static Sensitivity

Gallium arsenide integrated circuits are ESD sensitive and can be damaged by static electricity. Use proper ESD precautions when handling these devices.

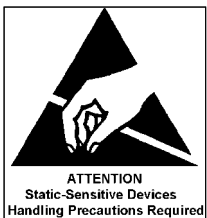

Specifications subject to change without notice.

- North America: Tel. (800) 366-2266
- Asia/Pacific: Tel.+81-44-844-8296, Fax +81-44-844-8298
- Europe: Tel. +44 (1344) 869 595, Fax+44 (1344) 300 020

Visit www.macom.com for additional data sheets and product information.

tyco / Electronics

M/ACOM

Typical Performance

Insertion Loss vs. Frequency, over Temperature

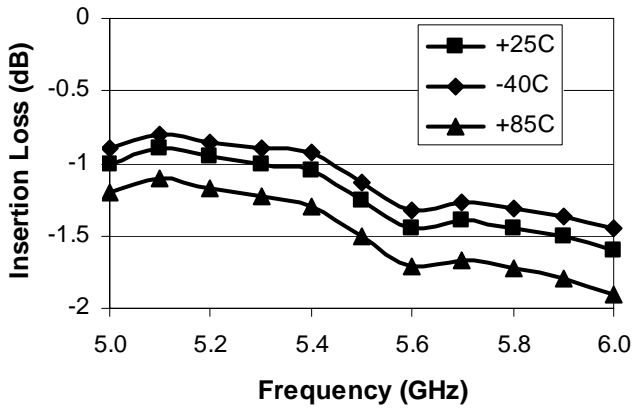

Insertion Loss vs. Frequency, T_A = +25°C

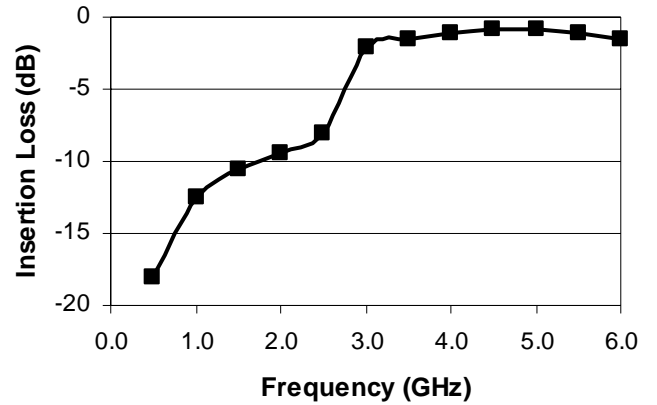

Isolation vs. Frequency, over Temperature

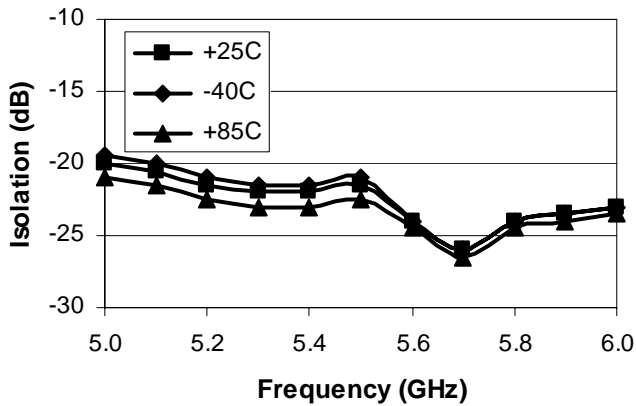

Return Loss vs. Frequency, over Temperature

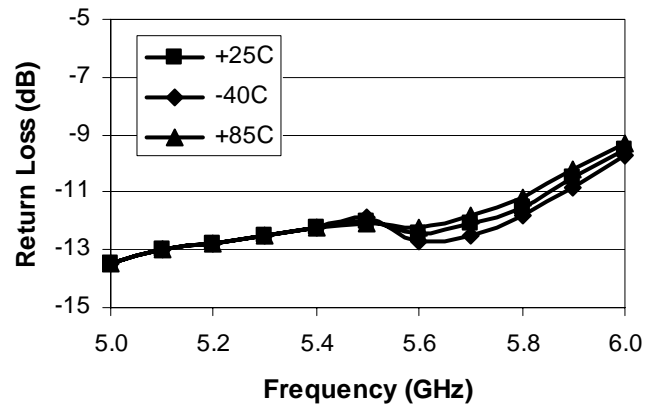

Specifications subject to change without notice.

- North America: Tel. (800) 366-2266
- Asia/Pacific: Tel.+81-44-844-8296, Fax +81-44-844-8298
- Europe: Tel. +44 (1344) 869 595, Fax+44 (1344) 300 020

Visit www.macom.com for additional data sheets and product information.



4 mm, 16 Pin FQFP-N Package

Dimension	Measurement (mm)		
	Min.	Nom.	Max.
A	0.80	0.90	1.00
A1	0	0.02	0.05
A2	0.80	0.88	1.00
b	0.23	0.30	0.38
D		4.00	
D2	2.05	2.15	2.25
e		0.65	
E		4.00	
E2	2.00	2.15	2.25
L	0.40	0.55	0.65

Note: See JEDEC MO-220A VGGC Issue B for additional dimensional and tolerance information.

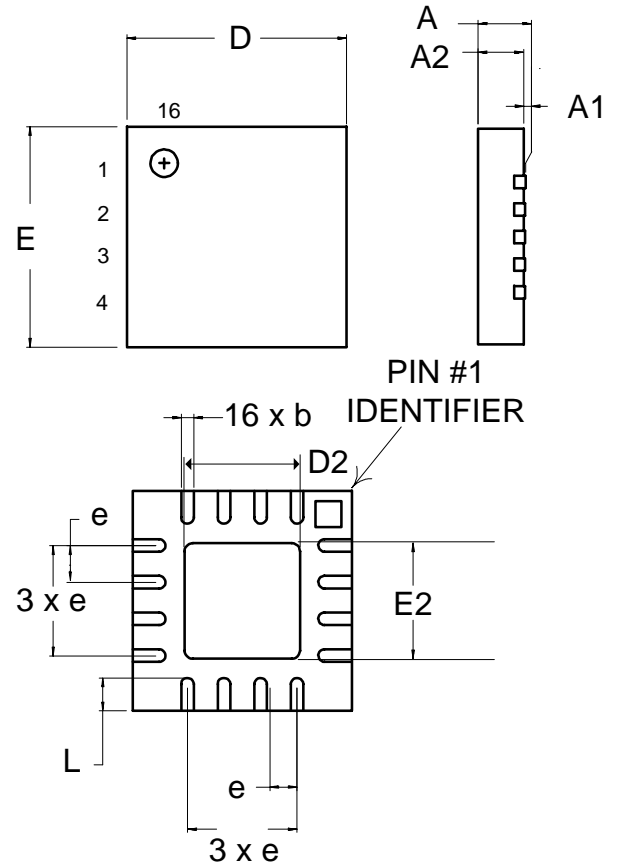

Specifications subject to change without notice.

- North America: Tel. (800) 366-2266
- Asia/Pacific: Tel.+81-44-844-8296, Fax +81-44-844-8298
- Europe: Tel. +44 (1344) 869 595, Fax+44 (1344) 300 020

Visit www.macom.com for additional data sheets and product information.