

Precision Adjustable Shunt Regulator

Monolithic IC MM1431 AT/AN

Outline

The MM1431AT/AN is 3-terminal adjustable shunt regulator, which provides a highly accurate 0.8% bandgap reference voltage. The output voltage can be adjusted to any value between reference voltage V_{REF} and 35 volts with two external resistors. Moreover, there are a lot of ranges of the application as a zener diode besides the replacement is possible because it has steep turn-on characteristics.

Features

- | | |
|-----------------------------------|-------------------------------|
| 1. Reference voltage tolerance | $V_{REF}=2.495V\pm 0.8\%$ |
| 2. Output voltage can be adjusted | $V_{REF}\leq V_o\leq 35V$ |
| 3. Low Dynamic Output Impedance | $ Z_{KA} \leq 0.2\Omega$ typ. |

Package

TO-92
SOT-25

Pin Assignment

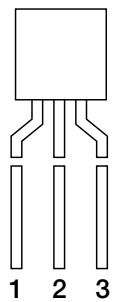

TO-92

1	Reference
2	Anode
3	Cathode

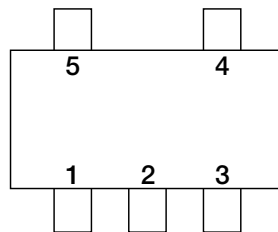

SOT-25
(TOP VIEW)

1	NC
2	SUB
3	Cathode
4	Reference
5	Anode

note: The second terminal is SUB, so connect the terminal to GND.

Equivalent Circuit Diagram

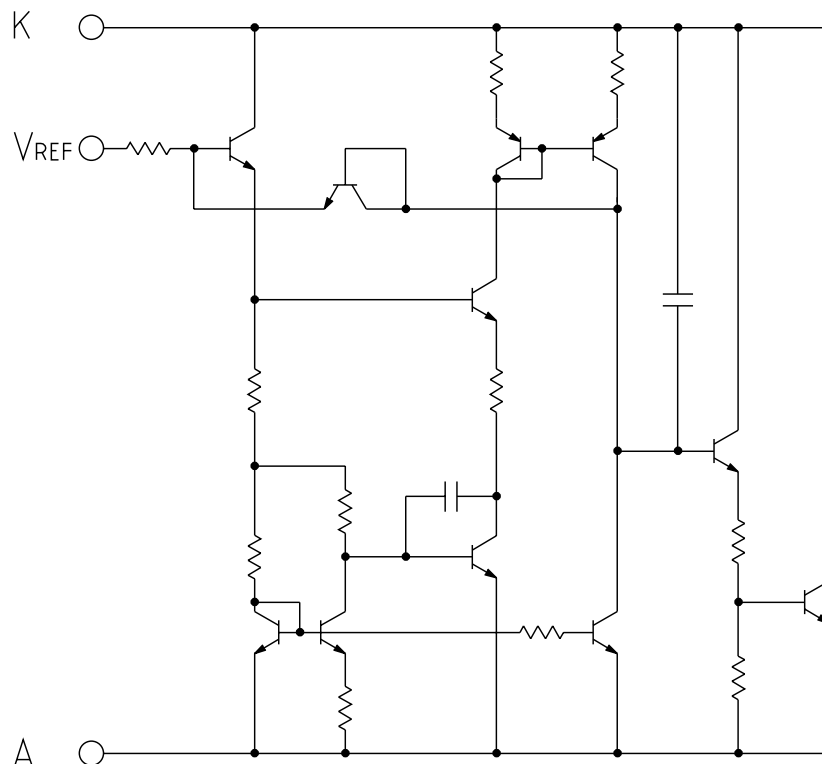

Absolute Maximum Ratings (Ambient Temperature, $T_a=25^\circ\text{C}$)

Item	Symbol	Ratings	Unit
Operating Temperature	T_{OPR}	-30~+85	$^\circ\text{C}$
Storage Temperature	T_{STG}	-40~+125	$^\circ\text{C}$
Cathode to Anode voltage	V_{KA}	35	V
Cathode current	I_K	-100~100	mA
Reference input current	I_{REF}	-0.05~10	mA
Allowable loss	P_d	500 (TO-92) 150 (SOT-25)	mW

Recommended Operating Conditions (Ambient Temperature, $T_a=25^\circ\text{C}$)

Cathode to Anode voltage	V_{KA}	$V_{REF}-35$	V
Cathode current	I_K	0.6~50	mA

Electrical Characteristics (Ambient Temperature, $T_a=25^\circ\text{C}$)

Item	Symbol	Measurement conditions	Min.	Typ.	Max.	Unit
Reference voltage	V_{REF}	$V_{KA}=V_{REF}, I_K=10\text{mA}$	2.475	2.495	2.515	V
Reference voltage deviation over temperature range	$\Delta V_{REF}/\Delta T_a$	$V_{KA}=V_{REF}, I_K=10\text{mA}$ $T_a=-30\sim+85^\circ\text{C}$		± 10		mV
Load regulation	ΔV_{REF}	$\Delta V_{KA}=V_{REF}\sim 10\text{V}$ $I_K=10\text{mA}$		-1.4	-2.7	mV/V
	ΔV_{KA}	$\Delta V_{KA}=10\text{V}\sim 35\text{V}$ $I_K=10\text{mA}$		-1	-2	mV/V
Reference input current	I_{REF}	$I_K=10\text{mA}$ $R_1=10\text{K}$, $R_2=\infty$		1	4	μA
Reference input current deviation over temperature range	$\Delta I_{REF}/\Delta T_a$	$I_K=10\text{mA}$ $R_1=10\text{K}$, $R_2=\infty$ $T_a=-30\sim+85^\circ\text{C}$		± 0.5		μA
Minimum Cathode Current	$I_{Kmin.}$	$V_{KA}=V_{REF}$		0.3	0.6	mA
Off-state Cathode Current	I_{OFF}	$V_{KA}=35\text{V}$, $V_{REF}=0\text{V}$		0.1	1.0	μA
Dynamic Impedance	$ Z_{KA} $	$V_{KA}=V_{REF}$, $f \leq 1\text{kHz}$ $I_K=1\sim 50\text{mA}$		0.2	0.5	Ω

Measuring Circuit

(1) $V_{KA}=V_{REF}$

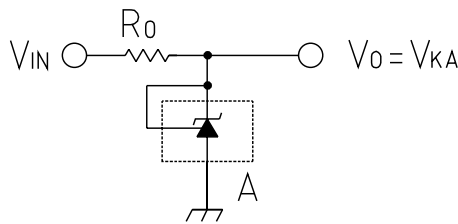

(3) I_{OFF}

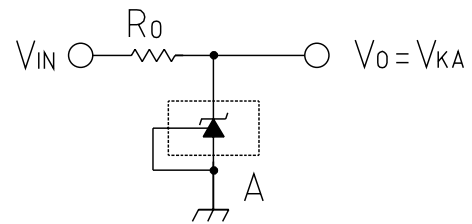

(2) $V_{KA} \geq V_{REF}$ $V_0 = V_{KA} = V_{REF}$

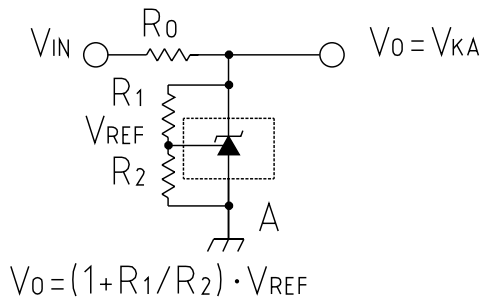

(4) Open Loop Voltage Gain

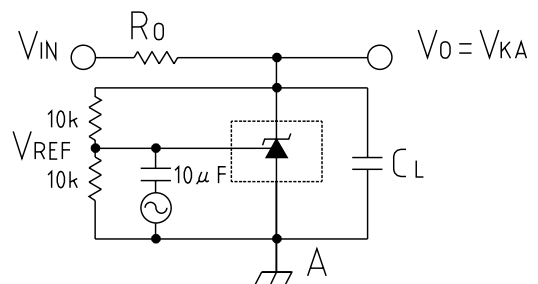

Characteristics

High Voltage Operating Characteristics

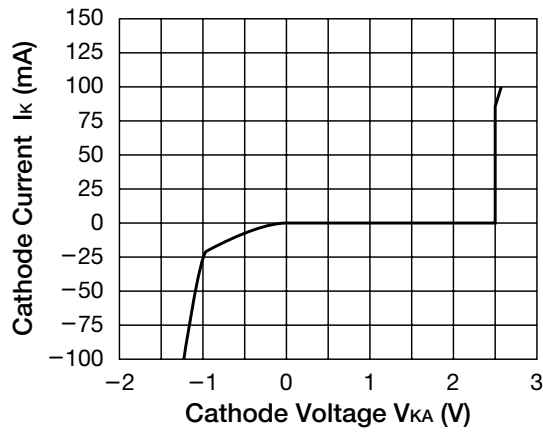

Reference Input Current

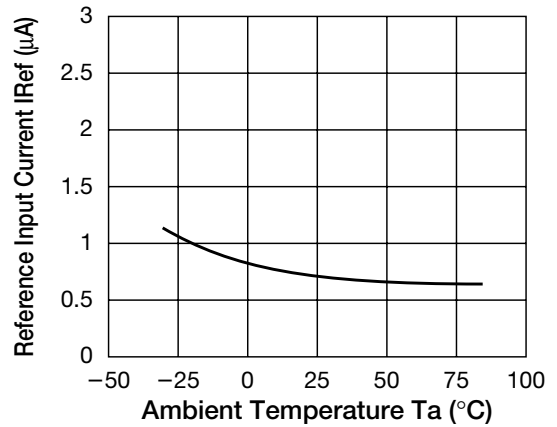

Low Current Operating Characteristics

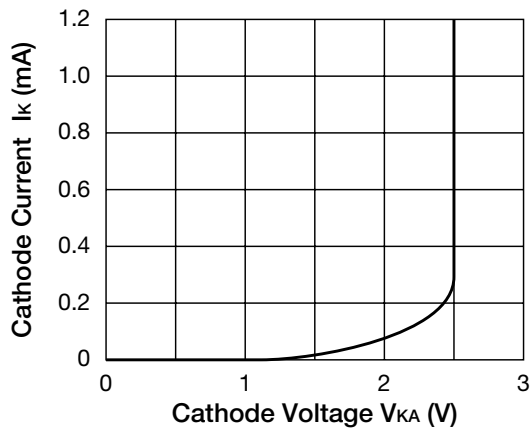

Reference Voltage

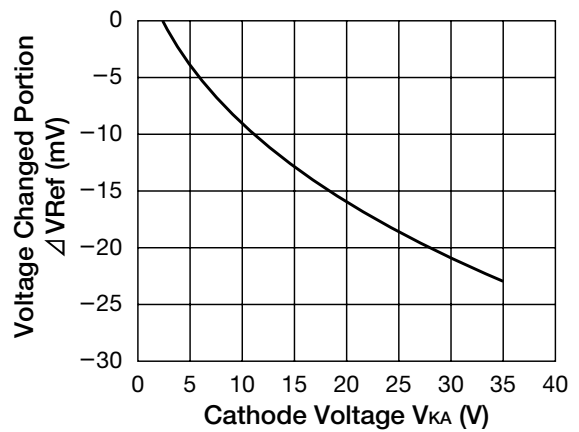

Reference Voltage

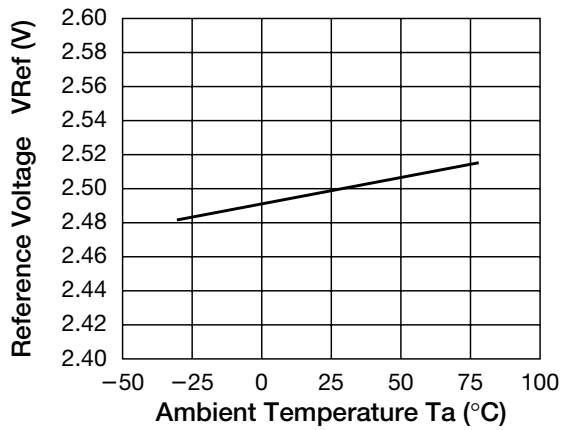

Off State Leakage

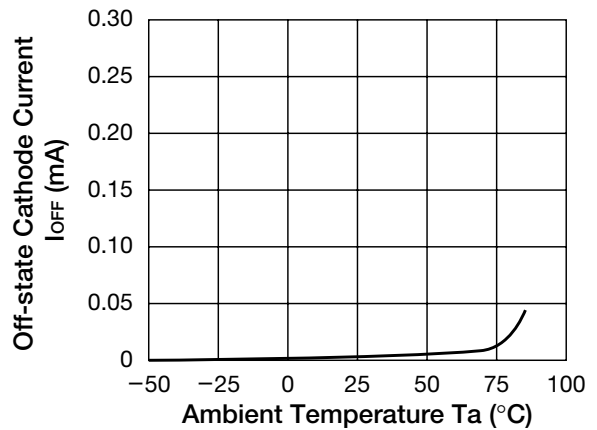

■ Dynamic Output Impedance

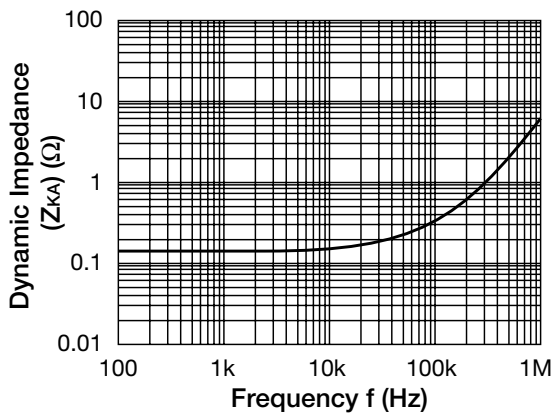

■ Open loop Voltage Gain $V_{KA}=5V$

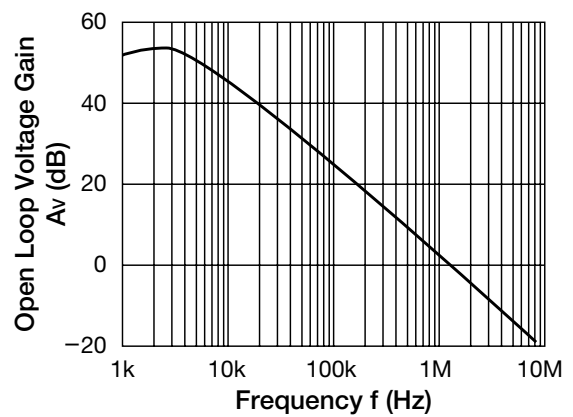

■ Pulse Response

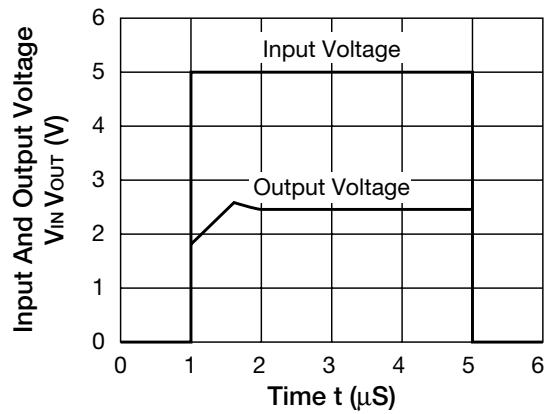

■ Stability Boundary Conditions

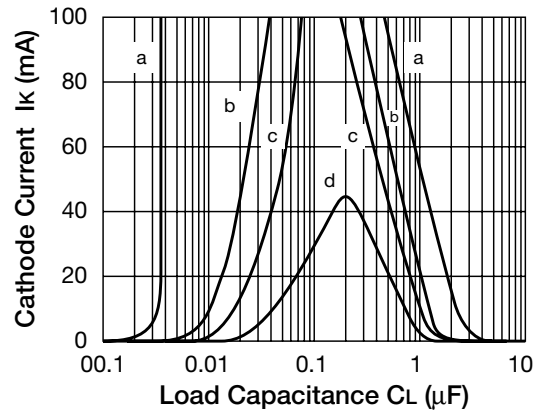

a: $V_{KA}=V_{REF}$ b: $V_{KA}=5V$ c: $V_{KA}=10V$
 d: $V_{KA}=15V$
 Cathode voltage temperature $T_a=25^\circ C$
 $I_{KA}=10mA$ C_L : Ceramic capacitor

Notes concerning stability operation region

The MM1431AT/AN requires external capacitors for regulator stability. These capacitors must be correctly selected for good performance.