

*Designer's™ Data Sheet*  
**SCANSWITCH™ Power Rectifier**  
**For Use As A Damper Diode**  
**In High and Very High Resolution Monitors**

**MUR10150E**

Motorola Preferred Device

**SCANSWITCH  
RECTIFIER  
10 AMPERES  
1500 VOLTS**

The MUR10150E is a state-of-the-art Power Rectifier specifically designed for use as a damper diode in horizontal deflection circuits for high and very high resolution monitors. In these applications, the outstanding performance of the MUR10150E is fully realized when paired with either the MJW16212 or MJF16212 monitor specific, 1500 V bipolar power transistor.

- 1500 V Blocking Voltage
- 20 mJ Avalanche Energy Guaranteed
- Peak Transient Overshoot Voltage Specified, 14 Volts (typical)
- Forward Recovery Time Specified, 135 ns (typical)
- Epoxy Meets UL94, V<sub>O</sub> at 1/8"

**Mechanical Characteristics**

- Case: Epoxy, Molded
- Weight: 1.9 grams (approximately)
- Finish: All External Surfaces Corrosion Resistant and Terminal Leads are Readily Solderable
- Lead Temperature for Soldering Purposes: 260°C Max. for 10 Seconds
- Shipped 50 units per plastic tube
- Marking: U10150E

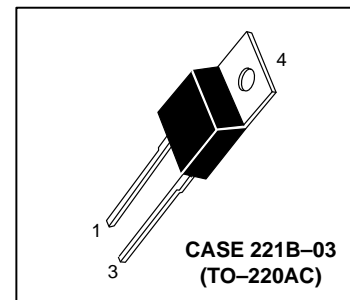
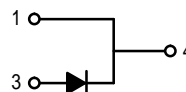

**MAXIMUM RATINGS**

Rating	Symbol	Value	Unit
Peak Repetitive Reverse Voltage Working Peak Reverse Voltage DC Blocking Voltage	V <sub>RRM</sub> V <sub>VRM</sub> V <sub>R</sub>	1500	Volts
Average Rectified Forward Current, (Rated V <sub>R</sub> ), T <sub>C</sub> = 125°C	I <sub>F(AV)</sub>	10	Amps
Peak Repetitive Forward Current, Per Leg (Rated V <sub>R</sub> , Square Wave, 20 kHz), T <sub>C</sub> = 125°C	I <sub>FRM</sub>	20	Amps
Nonrepetitive Peak Surge Current (Surge applied at rated load conditions halfwave, single phase, 60 Hz)	I <sub>FSM</sub>	100	Amps
Operating Junction and Storage Temperature	T <sub>J</sub> , T <sub>stg</sub>	-65 to +125	°C
Controlled Avalanche Energy	W <sub>AVAIL</sub>	20	mJ

**THERMAL CHARACTERISTICS**

Thermal Resistance — Junction to Case	R <sub>θJC</sub>	2.0	°C/W
---------------------------------------	------------------	-----	------

**ELECTRICAL CHARACTERISTICS**

Characteristic	Symbol	Typ	Max	Unit
Maximum Instantaneous Forward Voltage (1) (i <sub>F</sub> = 6.5 Amps, T <sub>J</sub> = 125°C) (i <sub>F</sub> = 6.5 Amps, T <sub>J</sub> = 25°C)	v <sub>F</sub>	1.7 1.9	2.2 2.4	Volts
Maximum Instantaneous Reverse Current (1) (Rated dc Voltage, T <sub>J</sub> = 125°C) (Rated dc Voltage, T <sub>J</sub> = 25°C)	i <sub>R</sub>	750 25	1000 100	μA
Maximum Reverse Recovery Time (I <sub>F</sub> = 1.0 Amp, di/dt = 50 Amps/μs)	t <sub>rr</sub>	150	175	ns
Maximum Forward Recovery Time (I <sub>F</sub> = 6.5 Amps, di/dt = 12 Amps/μs)	t <sub>fr</sub>	135	175	ns
Peak Transient Overshoot Voltage	V <sub>RFM</sub>	14	16	Volts

(1) Pulse Test: Pulse Width = 300 μs, Duty Cycle ≤ 2.0%

SCANSWITCH is a trademark of Motorola, Inc.

**Designer's Data for "Worst Case" Conditions** — The Designer's Data Sheet permits the design of most circuits entirely from the information presented. SOA Limit curves — representing boundaries on device characteristics — are given to facilitate "worst case" design.

**Preferred** devices are Motorola recommended choices for future use and best overall value.

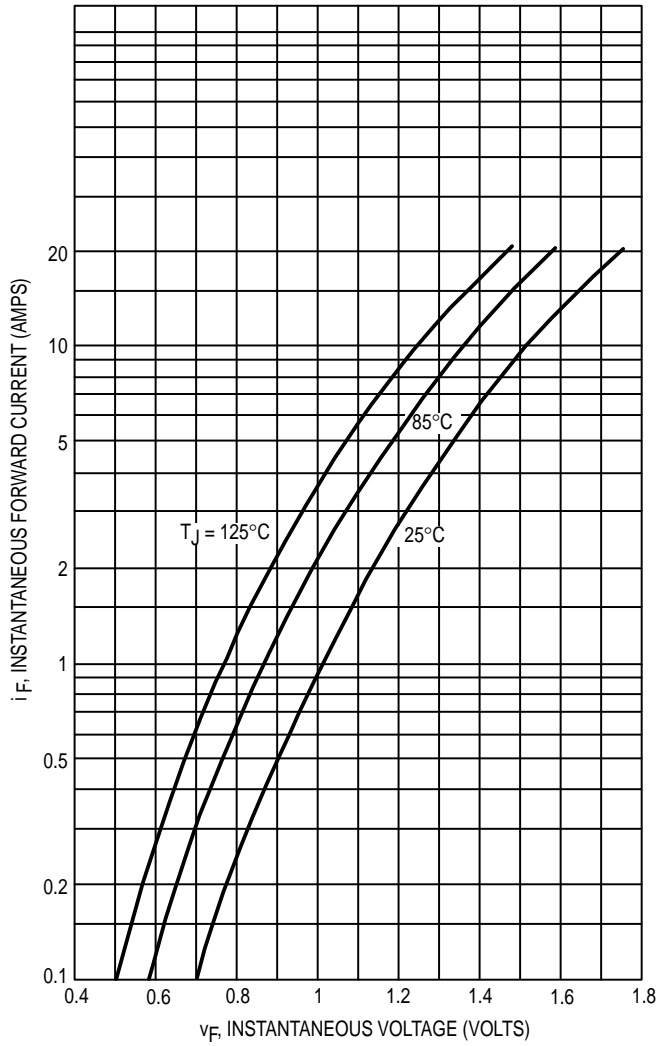

Figure 1. Typical Forward Voltage

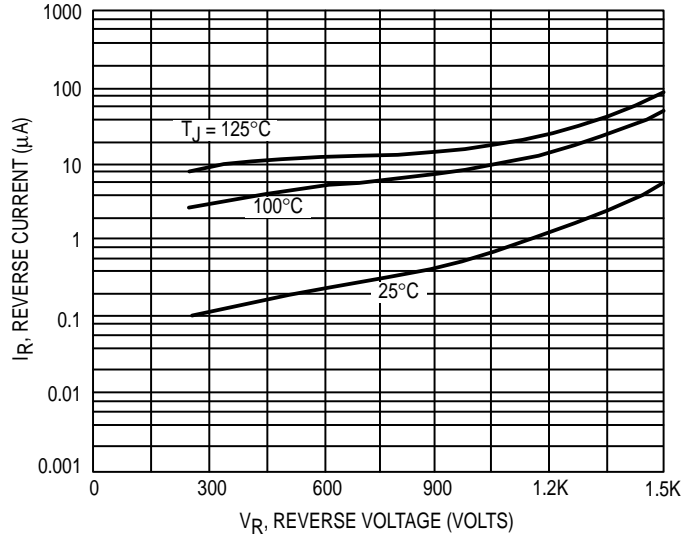

Figure 2. Typical Reverse Current

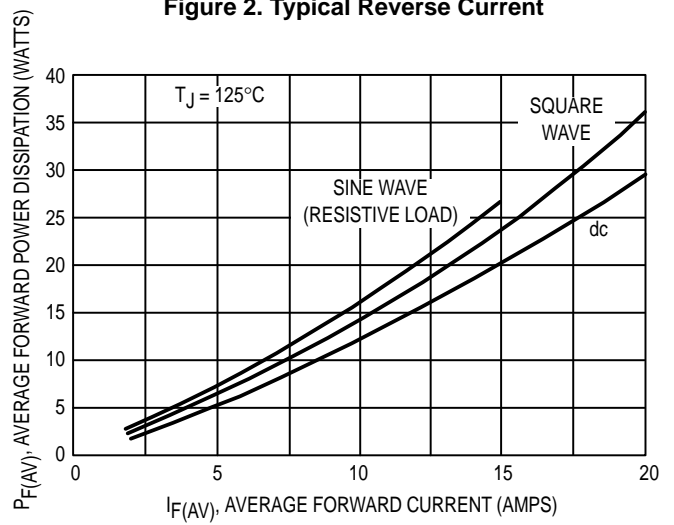

Figure 3. Forward Power Dissipation

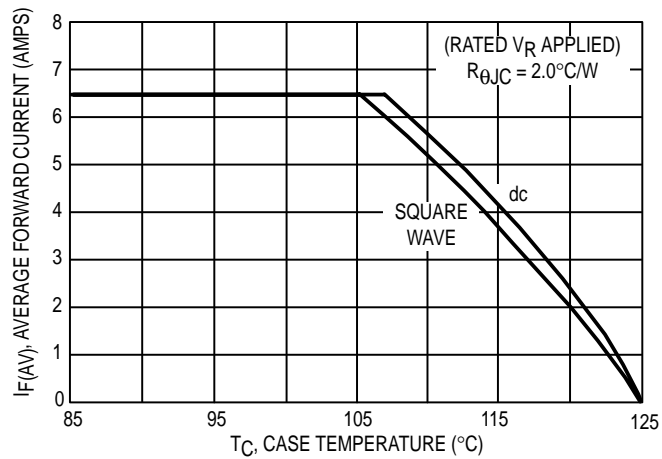

Figure 4. Current Derating Case

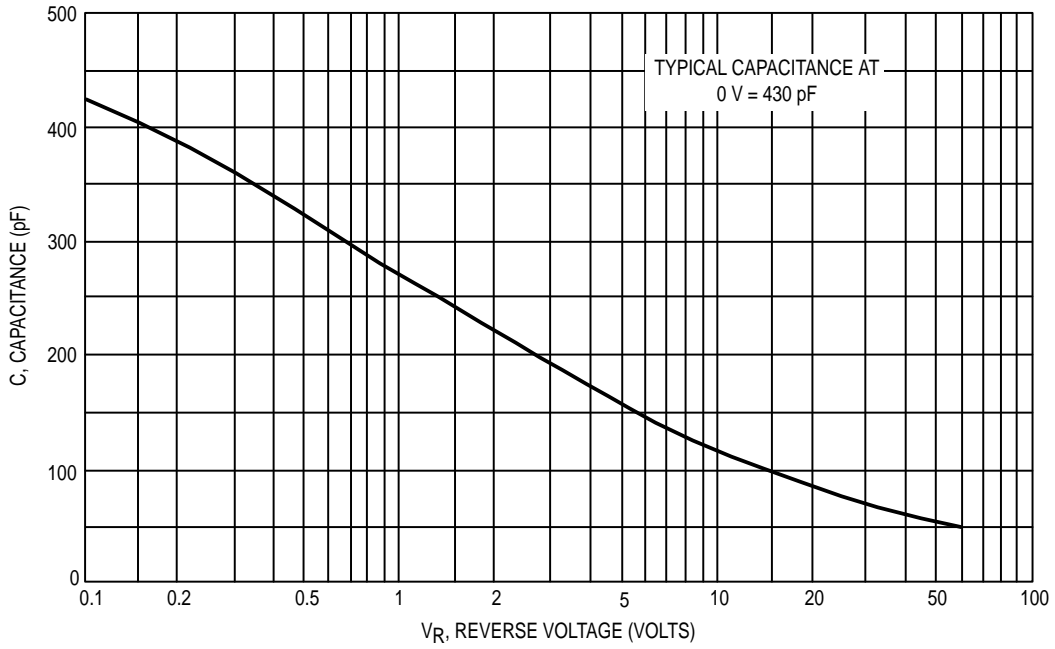

Figure 5. Typical Capacitance

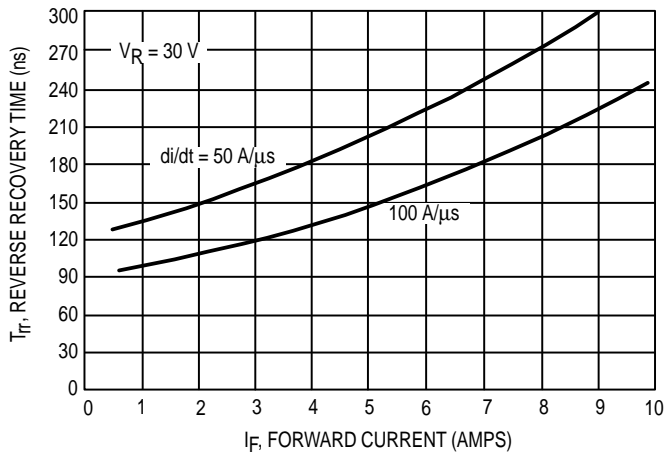

Figure 6. Typical Reverse Recovery Time

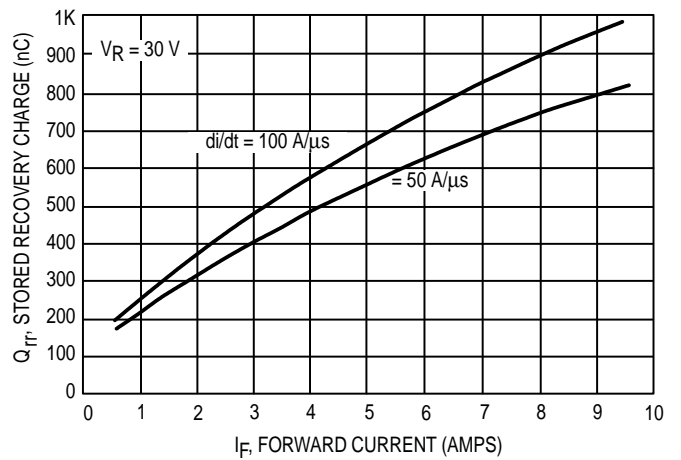
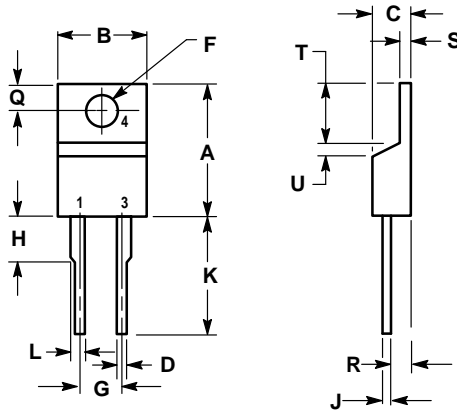

Figure 7. Typical Stored Recovery Charge

PACKAGE DIMENSIONS



- NOTES:  
 1. DIMENSIONING AND TOLERANCING PER ANSI Y14.5M, 1982.  
 2. CONTROLLING DIMENSION: INCH.

DIM	INCHES		MILLIMETERS	
	MIN	MAX	MIN	MAX
A	0.595	0.620	15.11	15.75
B	0.380	0.405	9.65	10.29
C	0.160	0.190	4.06	4.82
D	0.025	0.035	0.64	0.89
F	0.142	0.147	3.61	3.73
G	0.190	0.210	4.83	5.33
H	0.110	0.130	2.79	3.30
J	0.018	0.025	0.46	0.64
K	0.500	0.562	12.70	14.27
L	0.045	0.060	1.14	1.52
Q	0.100	0.120	2.54	3.04
R	0.080	0.110	2.04	2.79
S	0.045	0.055	1.14	1.39
T	0.235	0.255	5.97	6.48
U	0.000	0.050	0.000	1.27

- STYLE 1:  
 PIN 1. CATHODE  
 2. N/A  
 3. ANODE  
 4. CATHODE

CASE 221B-03  
 (TO-220AC)  
 ISSUE B

Motorola reserves the right to make changes without further notice to any products herein. Motorola makes no warranty, representation or guarantee regarding the suitability of its products for any particular purpose, nor does Motorola assume any liability arising out of the application or use of any product or circuit, and specifically disclaims any and all liability, including without limitation consequential or incidental damages. "Typical" parameters which may be provided in Motorola data sheets and/or specifications can and do vary in different applications and actual performance may vary over time. All operating parameters, including "Typicals" must be validated for each customer application by customer's technical experts. Motorola does not convey any license under its patent rights nor the rights of others. Motorola products are not designed, intended, or authorized for use as components in systems intended for surgical implant into the body, or other applications intended to support or sustain life, or for any other application in which the failure of the Motorola product could create a situation where personal injury or death may occur. Should Buyer purchase or use Motorola products for any such unintended or unauthorized application, Buyer shall indemnify and hold Motorola and its officers, employees, subsidiaries, affiliates, and distributors harmless against all claims, costs, damages, and expenses, and reasonable attorney fees arising out of, directly or indirectly, any claim of personal injury or death associated with such unintended or unauthorized use, even if such claim alleges that Motorola was negligent regarding the design or manufacture of the part. Motorola and are registered trademarks of Motorola, Inc. Motorola, Inc. is an Equal Opportunity/Affirmative Action Employer.

Mfax is a trademark of Motorola, Inc.

How to reach us:

USA/EUROPE/Locations Not Listed: Motorola Literature Distribution;  
 P.O. Box 5405, Denver, Colorado 80217. 303-675-2140 or 1-800-441-2447

JAPAN: Nippon Motorola Ltd.; Tatsumi-SPD-JLDC, 6F Seibu-Butsuryu-Center,  
 3-14-2 Tatsumi Koto-Ku, Tokyo 135, Japan. 81-3-3521-8315

Mfax™: RMFAX0@email.sps.mot.com – TOUCHTONE 602-244-6609  
 – US & Canada ONLY 1-800-774-1848

ASIA/PACIFIC: Motorola Semiconductors H.K. Ltd.; 8B Tai Ping Industrial Park,  
 51 Ting Kok Road, Tai Po, N.T., Hong Kong. 852-26629298

INTERNET: <http://motorola.com/sps>

