



HIGH CURRENT, LOW DROPOUT SURFACE MOUNT VOLTAGE REGULATORS

5232 SERIES

M.S.KENNEDY CORP.

4707 Dey Road Liverpool, N.Y. 13088

(315) 701-6751

FEATURES:

- Hermetic Surface Mount Package Option
- Extremely Low Dropout Voltage: 350mV @ 3 Amps
- Available in 1.5V, 1.7V, 1.8V, 1.9V, 2.5V, 3.3V, 5.0V and 12.0V
- On Board Thermal Shut Down
- Reverse Battery and Load Dump Protection
- Low Ground Current: 32mA Typical at Full Load
- 1% Maximum Guaranteed Accuracy
- Output Current to 3 Amps
- Alternate Output Voltages Available
- Improved Replacement for OM185SR
- Available in Four Lead Configurations
- Available with Top Tab or Tabless Package

MIL-PRF-38534 CERTIFIED

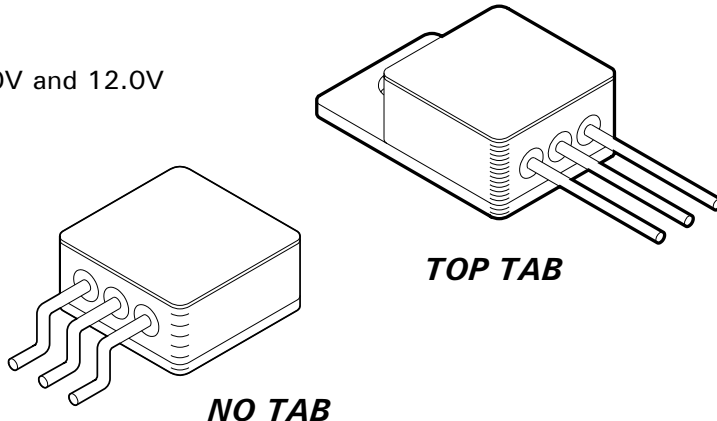

DESCRIPTION:

The MSK 5232 series voltage regulators are available in +1.5V, +1.7V, +1.8V, +1.9V, +2.5V, +3.3V, +5.0V, and +12.0V output configurations. All boast ultra low dropout specifications due to the utilization of a super PNP output pass transistor with monolithic technology. Dropout voltages of 350mV at 3 amps are typical in this configuration, which drives efficiency up and power dissipation down. Accuracy is guaranteed with a 1% maximum output voltage tolerance. The case of the MSK5232 series is electrically isolated for heat sinking purposes. The MSK5232 series is packaged in a space efficient 3 pin power package that is available lead formed for surface mount applications. The device is also available in a power package with a top tab to accommodate direct mounting to a heat sink.

EQUIVALENT SCHEMATIC

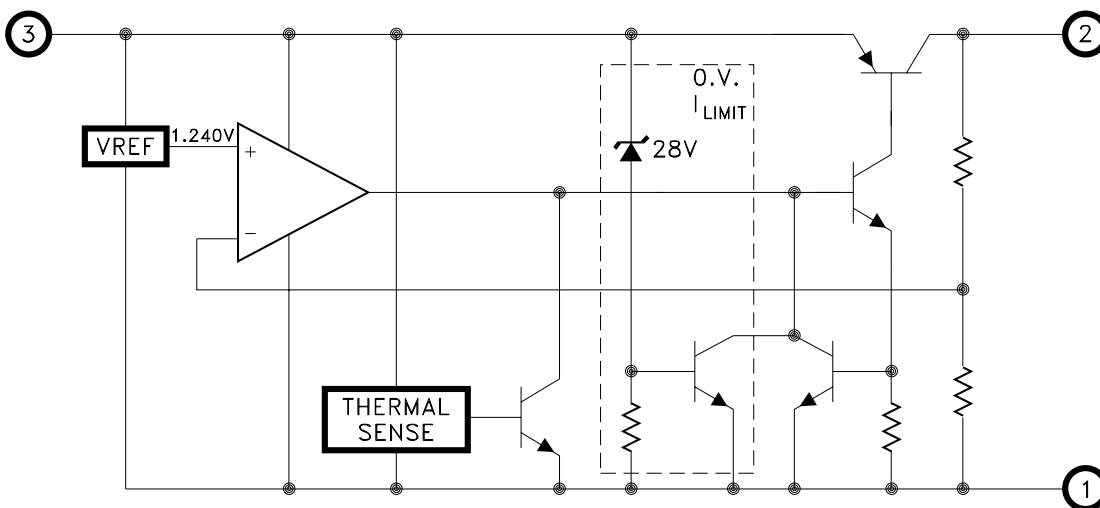

TYPICAL APPLICATIONS

- High Efficiency, High Current Linear Regulators
- Constant Voltage/Current Regulators
- System Power Supplies
- Switching Power Supply Post Regulators
- Battery Powered Equipment

PIN-OUT INFORMATION

- 1 GND
- 2 VOUT
- 3 VIN

ABSOLUTE MAXIMUM RATINGS

V_{INP} Input Voltage (100mS 1%D.C.) -20V to +60V
 V_{IN} Input Voltage 26V
 V_{EN} Enable Voltage -0.3V to 26V
 I_{OUT} Output Current 4A

T_{ST} Storage Temperature Range . . -65°C to +150°C
 T_{LD} Lead Temperature 300°C
 (10 Seconds Soldering)
 T_J Operating Temperature
 MSK 5232 Series -40°C to +85°C
 MSK 5232H/E Series -55°C to +125°C

ELECTRICAL SPECIFICATIONS

Parameter	Test Conditions ^{①③}	Group A Subgroup	MSK 5232H/E SERIES			MSK 5232 SERIES			Units
			Min.	Typ.	Max.	Min.	Typ.	Max.	
Output Voltage Tolerance	$I_{OUT} = 10mA; V_{IN} = V_{OUT} + 1V$	1	-	±0.5	±1.0	-	±0.5	±1.0	%
		2, 3	-	±1.0	±2.0	-	-	-	%
Dropout Voltage ^②	$\Delta V_{OUT} = -1%; I_{OUT} = 100 mA$	1	-	80	200	-	80	225	mV
	$\Delta V_{OUT} = -1%; I_{OUT} = 3A$	1	-	350	600	-	350	625	mV
Load Regulation ^⑧	$V_{IN} = V_{OUT} + 5V$ $10 mA \leq I_{OUT} \leq 2.5A$	1	-	±0.2	±1.0	-	±0.2	±1.2	%
		2, 3	-	±0.3	±2.0	-	±0.3	-	%
Line Regulation	$(V_{OUT} + 1V) \leq V_{IN} \leq 26V$ $I_{OUT} = 10 mA$	1	-	±0.05	±0.5	-	±0.05	±0.6	%
		2, 3	-	±0.5	±1.0	-	±0.5	-	%
Output Current Limit ^②	$V_{OUT} = 0V; V_{IN} = V_{OUT} + 1V$	1	-	4.5	5.0	-	4.5	5.0	A
Ground Current ^②	$V_{IN} = V_{OUT} + 1V; I_{OUT} = 1.5A$	1	-	20	45	-	20	45	mA
	$V_{IN} = V_{OUT} + 1V; I_{OUT} = 3A$	1	-	42	-	-	42	-	mA
Output Noise ^②	$C_L = 20\mu F; 10 Hz \leq f \leq 100 KHz$	-	-	400	-	-	400	-	μV
Thermal Resistance ^②	Junction to Case @ 125°C	-	-	6.2	6.5	-	6.2	6.8	°C/W
Thermal Shutdown ^②	T_J	-	-	130	-	-	130	-	°C

PART NUMBER	OUTPUT VOLTAGE ^⑦
MSK5232-1.5	+1.5V
MSK5232-1.7	+1.7V
MSK5232-1.8	+1.8V
MSK5232-1.9	+1.9V
MSK5232-2.5	+2.5V
MSK5232-3.3	+3.3V
MSK5232-5.0	+5.0V
MSK5232-12	+12.0V

NOTES:

- ① Output decoupled to ground using 47μF minimum capacitor unless otherwise specified.
- ② This parameter is guaranteed by design but need not be tested.
Typical parameters are representative of actual device performance but are for reference only.
- ③ All output parameters are tested using a low duty cycle pulse to maintain $T_J = T_C$.
- ④ Industrial grade and "E" suffix devices shall be tested to subgroup 1 unless otherwise specified.
- ⑤ Military grade devices ('H' suffix) shall be 100% tested to subgroups 1,2,3.
- ⑥ Subgroup 1 $T_C = +25^\circ C$
Subgroup 2 $T_J = +125^\circ C$
Subgroup 3 $T_A = -55^\circ C$
- ⑦ Please consult the factory if alternate output voltages are required.
- ⑧ Due to current limit, maximum output current may not be available at all values of V_{IN} - V_{OUT} and temperatures.
See typical performance curves for clarification.

APPLICATION NOTES

REGULATOR PROTECTION:

The MSK 5232 series is fully protected against reversed input polarity, overcurrent faults, overtemperature conditions (Pd) and transient voltage spikes of up to 60V. If the regulator is used in dual supply systems where the load is returned to a negative supply, the output voltage must be diode clamped to ground.

OUTPUT CAPACITOR:

The output voltage ripple of the MSK 5232 series voltage regulators can be minimized by placing a filter capacitor from the output to ground. The optimum value for this capacitor may vary from one application to the next, but a minimum of 20µF is recommended for optimum performance. Transient load response can also be improved by placing a capacitor directly across the load. The capacitor should not be an ultra-low ESR type. Tantalum capacitors are best for fast load transients but aluminum electrolytics will work fine in most applications.

LOAD CONNECTIONS:

In voltage regulator applications where very large load currents are present, the load connection is very important. The path connecting the output of the regulator to the load must be extremely low impedance to avoid affecting the load regulation specifications. Any impedance in this path will form a voltage divider with the load.

MINIMIZING POWER DISSIPATION:

Many applications can not take full advantage of the extremely low dropout specifications of the regulator due to large input to output voltage differences. The simple circuit below illustrates a method to reduce the input voltage at the regulator to just over the dropout specification to keep the internal power dissipation minimized:

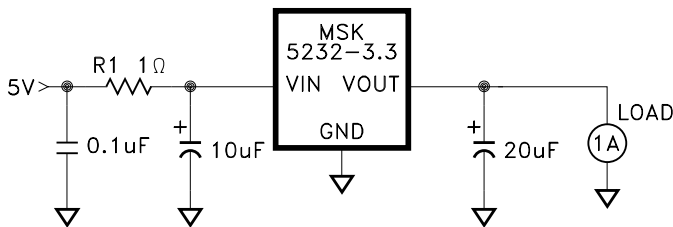

For a given continuous maximum load of 1 amp, R1 can be selected to drop the voltage seen at the regulator to 4V. This allows for the output tolerance and dropout specifications. Input voltage variations (5V) also should be included in the calculations. The resistor should be sized according to the power levels required for the application.

PACKAGE CONNECTIONS:

The MSK 5232 series are highly thermally conductive devices and the thermal path from the package heat sink to the internal junctions is very short. Standard surface mount soldering techniques should be used when mounting the device. Some applications may require additional heat sinking of the device.

HEAT SINK SELECTION:

To select a heat sink for the MSK 5232, the following formula for convective heat flow may be used.

Governing Equation:

$$T_j = P_d \times (R_{\theta jc} + R_{\theta cs} + R_{\theta sa}) + T_a$$

WHERE:

T_j = Junction Temperature

P_d = Total Power Dissipation

$R_{\theta jc}$ = Junction to Case Thermal Resistance

$R_{\theta cs}$ = Case to Heat Sink Thermal Resistance

$R_{\theta sa}$ = Heat Sink to Ambient Thermal Resistance

T_a = Ambient Temperature

First, the power dissipation must be calculated as follows:

$$\text{Power Dissipation} = (V_{in} - V_{out}) \times I_{out}$$

Next, the user must select a maximum junction temperature. The absolute maximum allowable junction temperature is 125°C. The equation may now be rearranged to solve for the required heat sink to ambient thermal resistance ($R_{\theta sa}$).

EXAMPLE:

An MSK 5232-1.8 is configured for $V_{in}=3.3V$ and $V_{out}=1.8V$. I_{out} is a continuous 1A DC level. The ambient temperature is +25°C. The maximum desired junction temperature is 125°C.

$R_{\theta jc} = 6.5^\circ C/W$ and $R_{\theta cs} = 0.5^\circ C/W$ typically.

$$\begin{aligned} \text{Power Dissipation} &= (3.3V - 1.8V) \times (1A) \\ &= 1.5 \text{ Watts} \end{aligned}$$

Solve for $R_{\theta sa}$:

$$R_{\theta sa} = \left[\frac{125^\circ C - 25^\circ C}{1.5W} \right] - 6.5^\circ C/W - 0.5^\circ C/W$$

In this example, a heat sink with a thermal resistance of no more than 60°C/W must be used to maintain a junction temperature of no more than 125°C.

TYPICAL PERFORMANCE CURVES

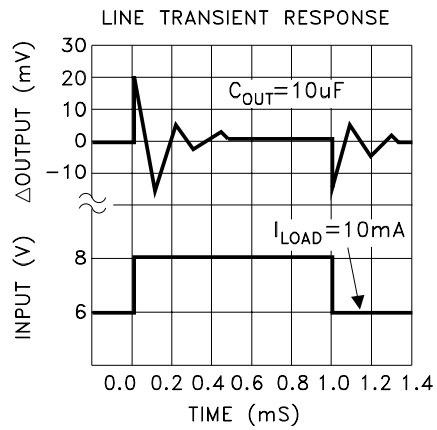
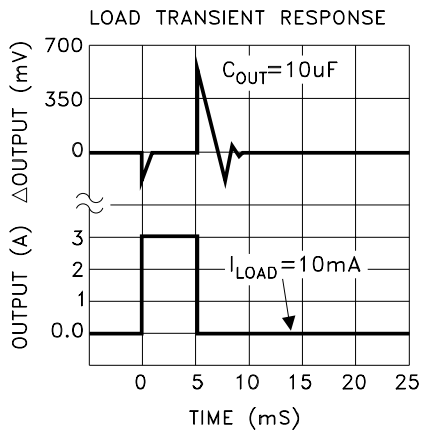
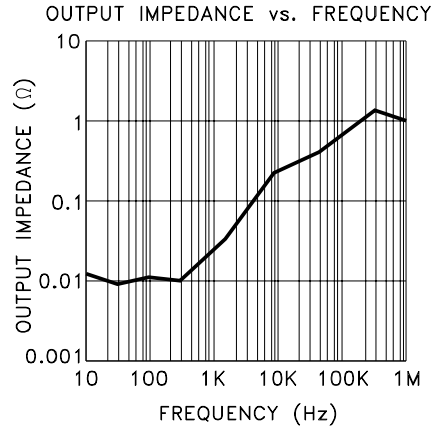
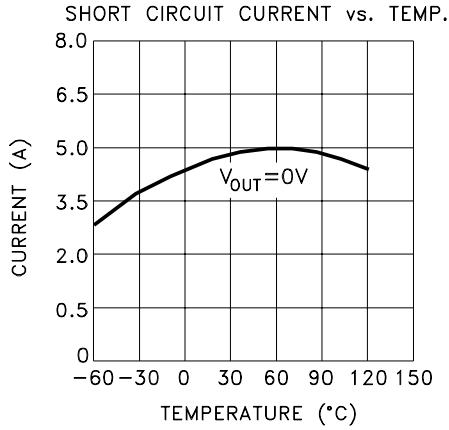
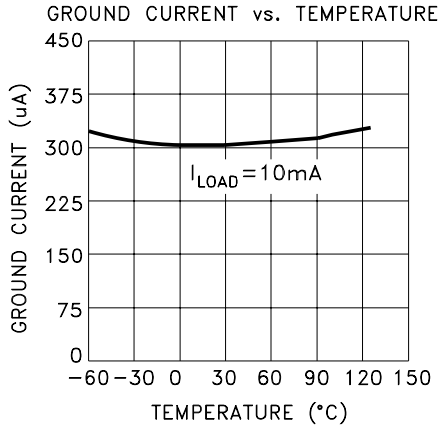
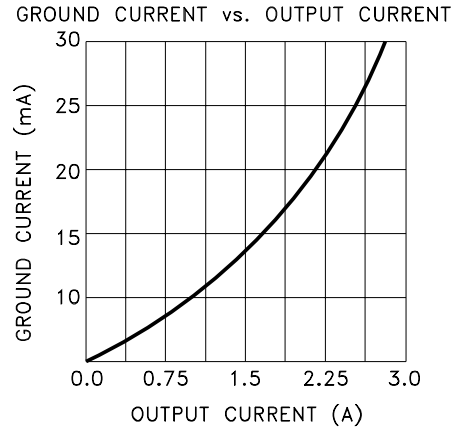
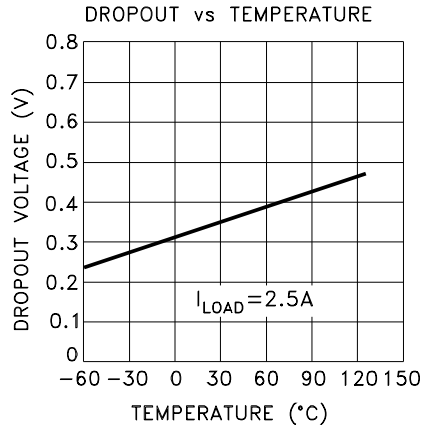
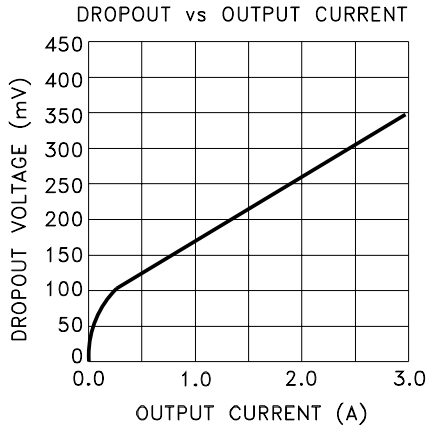

MECHANICAL SPECIFICATIONS

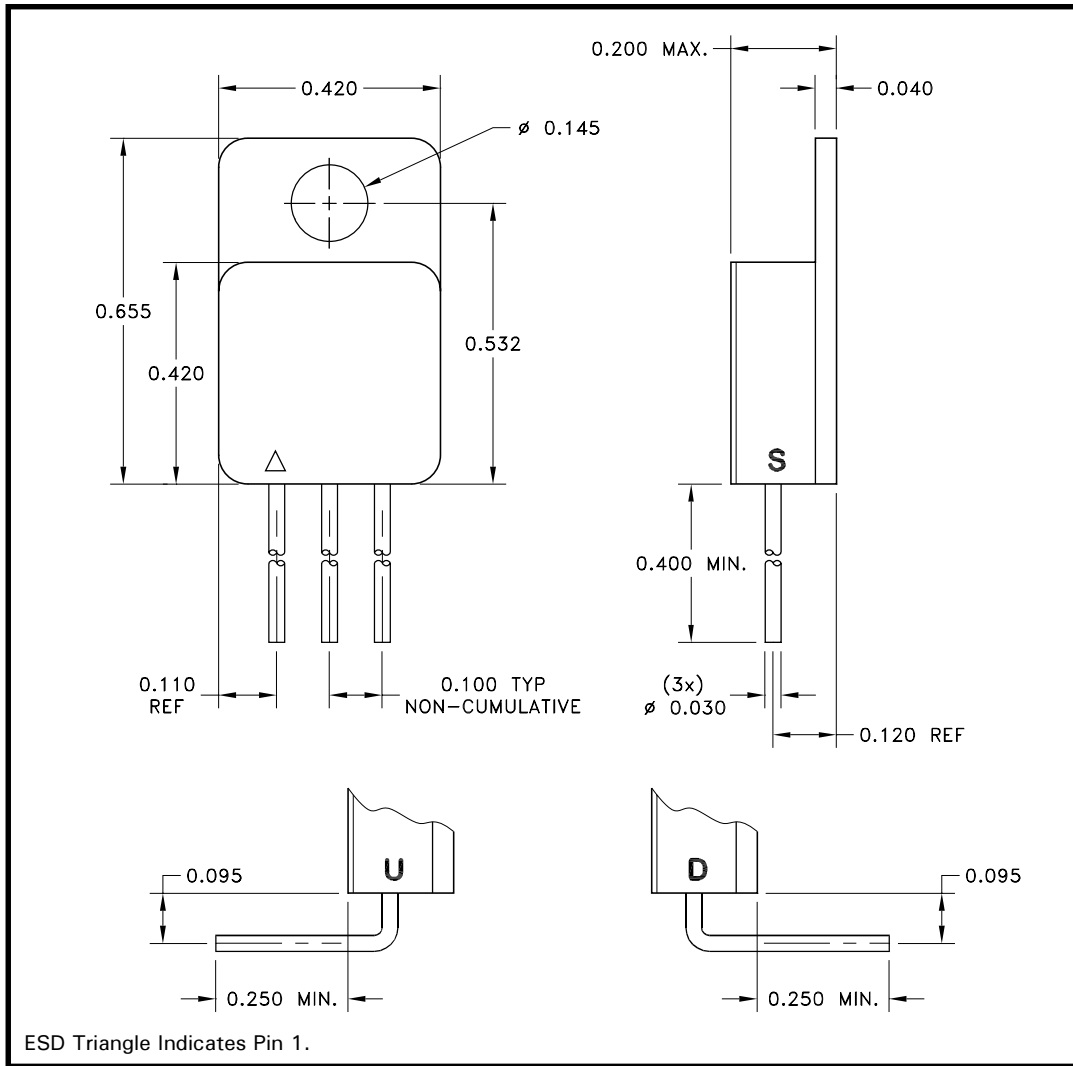

NOTE: ALL DIMENSIONS ARE ± 0.010 INCHES UNLESS OTHERWISE LABELED.

ORDERING INFORMATION

MSK5232-3.3 H T D

LEAD CONFIGURATIONS

(GULL WING NOT AVAILABLE WITH TOP TAB VERSION)

S = STRAIGHT; U = BENT UP; D = BENT DOWN

PACKAGE STYLE

T = TOP TAB; BLANK = NO TAB

SCREENING

BLANK = INDUSTRIAL; E = EXTENDED RELIABILITY

H = MIL-PRF-38534 CLASS H

OUTPUT VOLTAGE

1.5 = +1.5V; 1.7 = +1.7V; 1.8 = +1.8V; 1.9 = +1.9V;

2.5 = +2.5V; 3.3 = +3.3V; 5.0 = +5.0V; 12 = +12.0V

GENERAL PART NUMBER

MECHANICAL SPECIFICATIONS

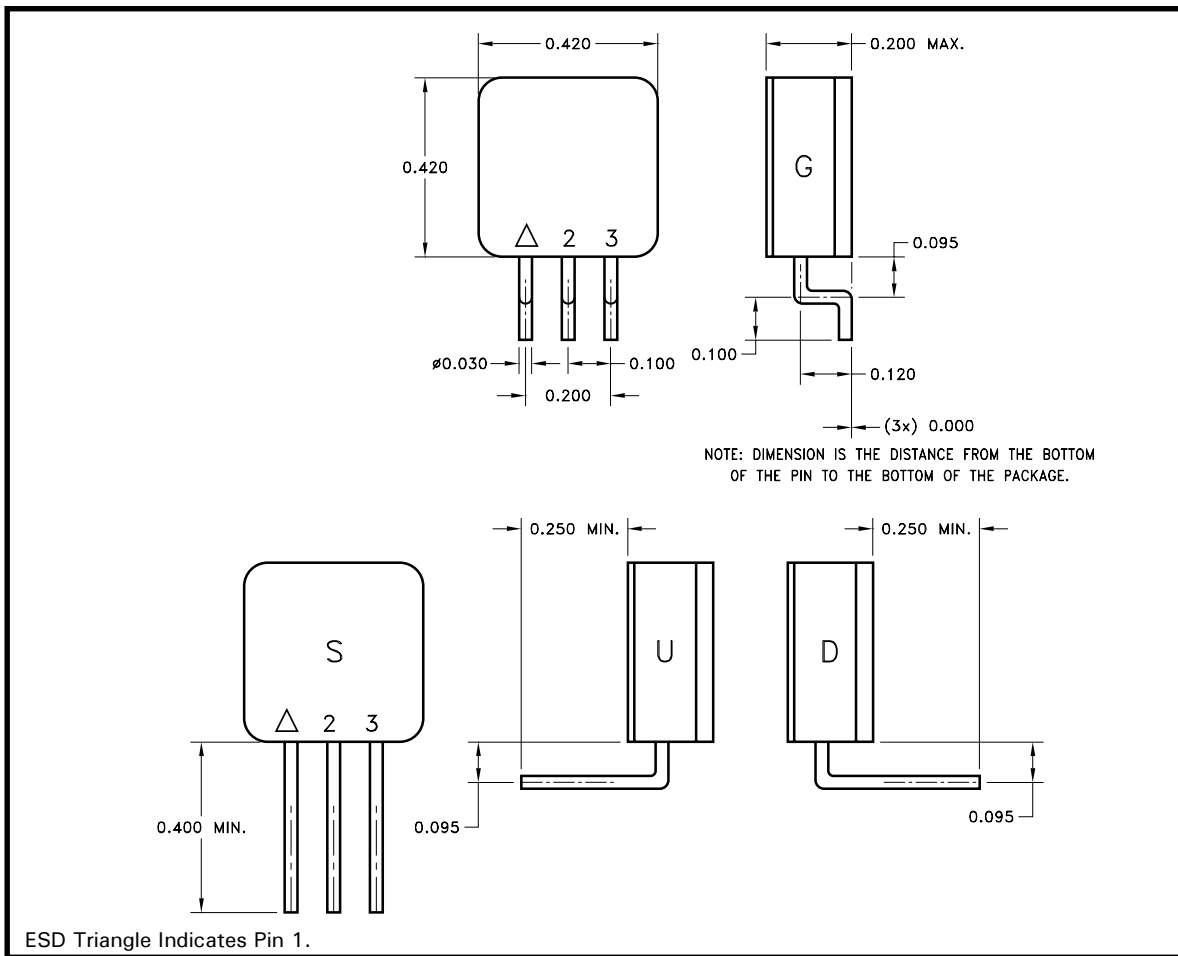

NOTE: ALL DIMENSIONS ARE ± 0.010 INCHES UNLESS OTHERWISE LABELED.

ORDERING INFORMATION

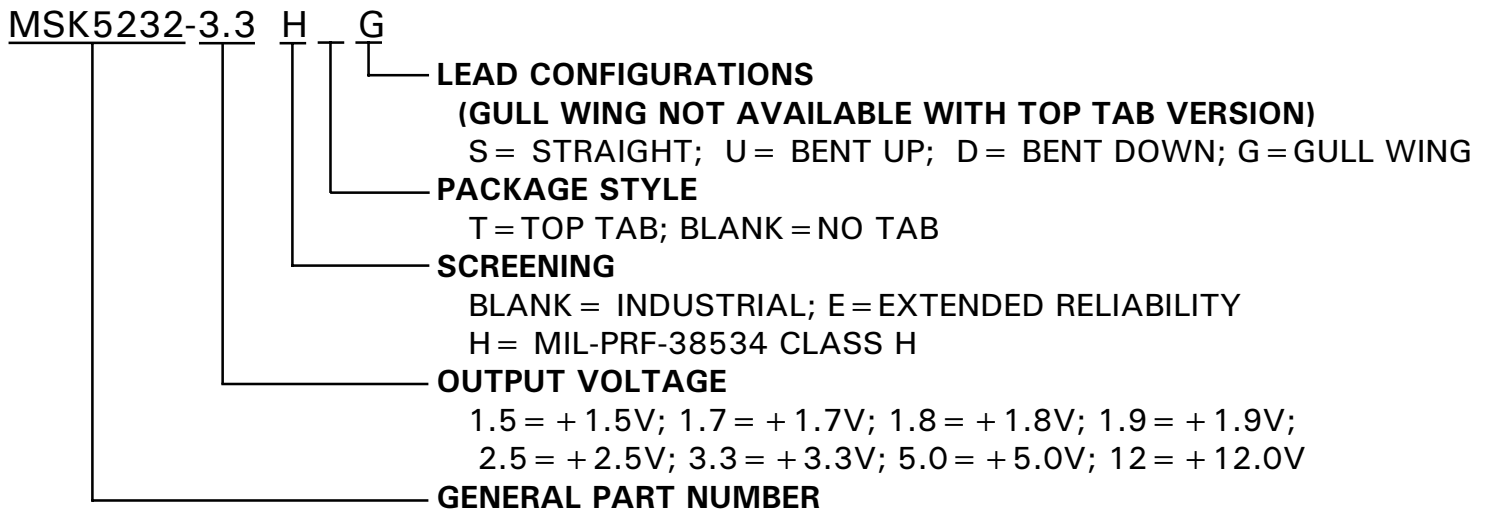

The above example is a +3.3V, Military regulator with gull wing leads.

M.S. Kennedy Corp.
4707 Dey Road, Liverpool, New York 13088
Phone (315) 701-6751
FAX (315) 701-6752
www.mskennedy.com

The information contained herein is believed to be accurate at the time of printing. MSK reserves the right to make changes to its products or specifications without notice, however, and assumes no liability for the use of its products. Please visit our website for the most recent revision of this datasheet.