

LM4911 Boomer® Audio Power Amplifier Series

Stereo 40mW Low Noise Headphone Amplifier with Selectable Capacitive Coupled or OCL Output

General Description

The LM4911 is an stereo audio power amplifier capable of delivering 40mW per channel of continuous average power into a 16Ω load or 25mW per channel into a 32Ω load at 1% THD+N from a 3V power supply.

Boomer audio power amplifiers were designed specifically to provide high quality output power with a minimal amount of external components. Since the LM4911 does not require bootstrap capacitors or snubber networks, it is optimally suited for low-power portable systems. In addition, the LM4911 may be configured for either single-ended capacitively coupled outputs or for OCL outputs (patent pending).

The LM4911 features a low-power consumption shutdown mode and a power mute mode that allows for faster turn on time with less than 1mV voltage change at outputs on release. Additionally, the LM4911 features an internal thermal shutdown protection mechanism.

The LM4911 is unity gain stable and may be configured with external gain-setting resistors.

Key Specifications

■ PSRR at 217 Hz and 1kHz	65dB (typ)
■ Output Power at 1kHz with $V_{DD} = 2.4V$, 1% THD+N into a 16Ω load	25mW (typ)
■ Output Power at 1kHz with $V_{DD} = 3V$, 1% THD+N into a 16Ω load	40mW (typ)
■ Shutdown Current	2.0μA (max)
■ Output Voltage change on release from Shutdown $V_{DD} = 2.4V$, $R_L = 16\Omega$ (C-Coupled)	1mV (max)
■ Mute Current	100μA (max)

Features

- OCL or capacitively coupled outputs (patent pending)
- External gain-setting capability
- Available in space-saving MSOP package
- Ultra low current shutdown mode
- Mute mode allows fast turn-on (1ms) with less than 1mV change on outputs
- 2V - 5.5V operation
- Ultra low noise

Applications

- Portable CD players
- PDAs
- Portable electronics devices

Block Diagram

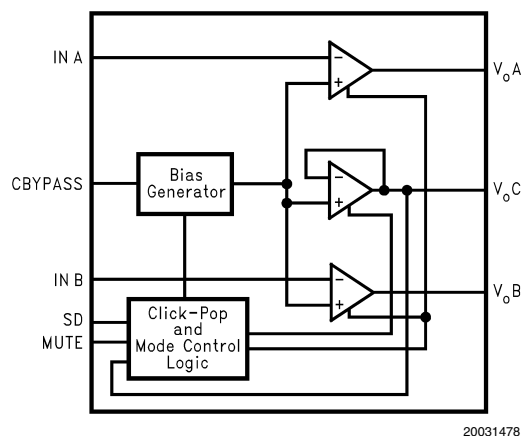
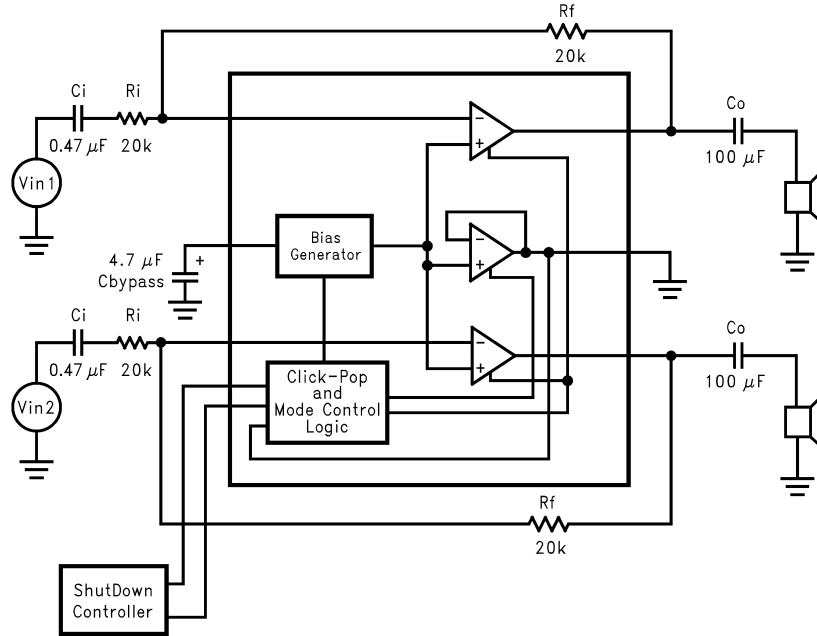

FIGURE 1. Block Diagram

Typical Application



20031480

FIGURE 2. Typical Capacitive Coupled Output Configuration Circuit

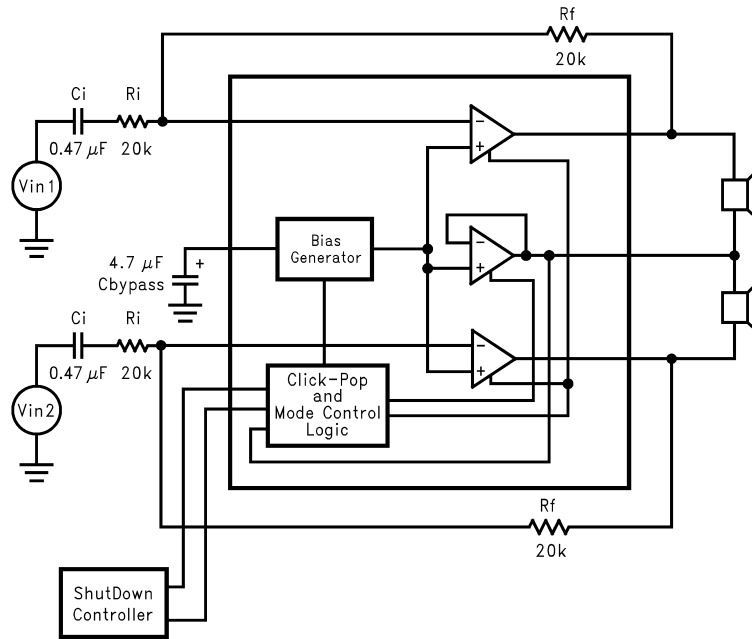

20031481

FIGURE 3. Typical OCL Output Configuration Circuit

Connection Diagrams

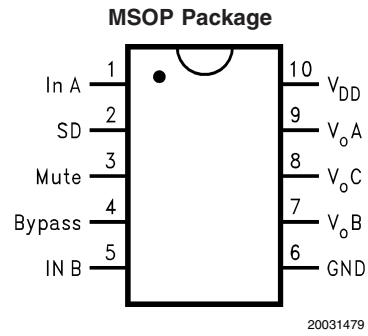

Top View
Order Number LM4911MM
See NS Package Number MUB10A

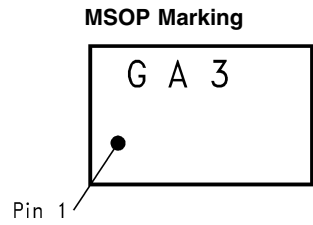

Top View
G-Boomer Family
A3 - LM4911MM

Absolute Maximum Ratings (Note 2)

If Military/Aerospace specified devices are required, please contact the National Semiconductor Sales Office/Distributors for availability and specifications.

Supply Voltage	6.0V
Storage Temperature	-65°C to +150°C
Input Voltage	-0.3V to $V_{DD} + 0.3V$
Power Dissipation (Note 3)	Internally Limited
ESD Susceptibility (Note 4)	2000V
ESD Susceptibility (Note 5)	200V
Junction Temperature	150°C

Thermal Resistance

 θ_{JC} (MSOP)

56°C/W

 θ_{JA} (MSOP)

190°C/W

Operating Ratings

Temperature Range

 $T_{MIN} \leq T_A \leq T_{MAX}$ $-40^\circ\text{C} \leq T_A \leq 85^\circ\text{C}$ Supply Voltage (V_{DD}) $2V \leq V_{CC} \leq 5.5V$ **Electrical Characteristics $V_{DD} = 5V$** (Notes 1, 2)

The following specifications apply for $V_{DD} = 5V$, $R_L = 16\Omega$, and $C_B = 4.7\mu\text{F}$ unless otherwise specified. Limits apply to $T_A = 25^\circ\text{C}$.

Symbol	Parameter	Conditions	LM4911		Units (Limits)
			Typ (Note 6)	Limit (Note 7)	
I_{DD}	Quiescent Power Supply Current	$V_{IN} = 0V, I_O = 0A$	2	5	mA (max)
I_{SD}	Shutdown Current	$V_{SHUTDOWN} = \text{GND}$	0.1		$\mu\text{A}(\text{max})$
I_M	Mute Current	$V_{MUTE} = V_{DD}, \text{C-Coupled}$	100		$\mu\text{A}(\text{max})$
V_{SDIH}	Shutdown Voltage Input High		1.8		V
V_{SDIL}	Shutdown Voltage Input Low		0.4		V
V_{MIH}	Mute Voltage Input High		1.8		V
V_{MIL}	Mute Voltage Input Low		0.4		V
P_O	Output Power	THD $\leq 1\%$; $f=1\text{ kHz}$ OCL, $R_L = 16\Omega$ OCL, $R_L = 32\Omega$ C-CUPL, $R_L = 16\Omega$ C-CUPL, $R_L = 32\Omega$	80 80 145 85		mW
V_{ON}	Output Noise Voltage	BW = 20Hz to 20kHz, A-weighted	10		μV
PSRR	Power Supply Rejection Ratio	$V_{RIPPLE} = 200\text{mV sine p-p}$ $f = 1\text{ kHz}$ (Note 9)	65		dB

Electrical Characteristics $V_{DD} = 3.0V$ (Notes 1, 2)

The following specifications apply for $V_{DD} = 3.0V$, $R_L = 16\Omega$, and $C_B = 4.7\mu\text{F}$ unless otherwise specified. Limits apply to $T_A = 25^\circ\text{C}$.

Symbol	Parameter	Conditions	LM4911		Units (Limits)
			Typ (Note 6)	Limit (Note 7)	
I_{DD}	Quiescent Power Supply Current	$V_{IN} = 0V, I_O = 0A$	1.5	3	mA (max)
I_{SD}	Shutdown Current	$V_{SHUTDOWN} = \text{GND}$	0.1	2.0	$\mu\text{A}(\text{max})$
I_M	Mute Current	$V_{MUTE} = V_{DD}, \text{C-Coupled}$	50	100	$\mu\text{A}(\text{max})$
P_O	Output Power	THD = 1%; $f = 1\text{ kHz}$ R = 16 Ω R = 32 Ω	40 25		mW
V_{NO}	Output Noise Voltage	BW = 20 Hz to 20kHz, A-weighted	10		μV
PSRR	Power Supply Rejection Ratio	$V_{RIPPLE} = 200\text{mV sine p-p}$	65		dB

Electrical Characteristics $V_{DD} = 2.4V$ (Notes 1, 2)

The following specifications apply for $V_{DD} = 2.4V$, $R_L = 16\Omega$, and $C_B = 4.7\mu F$ unless otherwise specified. Limits apply to $T_A = 25^\circ C$.

Symbol	Parameter	Conditions	LM4911		Units (Limits)
			Typ (Note 6)	Limit (Note 7)	
I_{DD}	Quiescent Power Supply Current	$V_{IN} = 0V, I_O = 0A$	1.5	3	mA (max)
I_{SD}	Shutdown Current	$V_{SHUTDOWN} = GND$	0.1	2.0	μA (max)
I_M	Mute Current	$V_{MUTE} = V_{DD}, C$ -Coupled	40	80	μA (max)
P_O	Output Power	THD = 1%; f = 1kHz			mW
		R = 16 Ω	25		
		R = 32 Ω	12		
V_{NO}	Output Noise Voltage	BW = 20 Hz to 20kHz, A-weighted	10		μV
PSRR	Power Supply Rejection Ratio	$V_{RIPPLE} = 200mV$ sine p-p	65		dB
T_{WU}	Wake Up Time from Shutdown	OCL	0.5		s
		C-Coupled, $C_O = 100\mu F$	2		
V_{OSD}	Output Voltage Change on Release from Shutdown	C-Coupled, $C_O = 100\mu F$		1	mV (max)
T_{UM}	Time to Un-Mute	C-Coupled, $C_O = 100\mu F$	0.01	0.02	s (max)

Note 1: All voltages are measured with respect to the GND pin unless otherwise specified.

Note 2: : Absolute Maximum Ratings indicate limits beyond which damage to the device may occur. Operating Ratings indicate conditions for which the device is functional but do not guarantee specific performance limits. Electrical Characteristics state DC and AC electrical specifications under particular test conditions which guarantee specific performance limits. This assumes that the device is within the Operating Ratings. Specifications are not guaranteed for parameters where no limit is given, however, the typical value is a good indication of device performance.

Note 3: : The maximum power dissipation must be derated at elevated temperatures and is dictated by T_{JMAX} , θ_{JA} , and the ambient temperature, T_A . The maximum allowable power dissipation is $P_{DMAX} = (T_{JMAX} - T_A) / \theta_{JA}$ or the number given in Absolute Maximum Ratings, whichever is lower. For the LM4911, see power derating currents for more information.

Note 4: Human body model, 100pF discharged through a 1.5k Ω resistor.

Note 5: Machine Model, 220pF-240pF discharged through all pins.

Note 6: Typical values are measured at 25 $^\circ C$ and represent the parametric norm.

Note 7: Limits are guaranteed to National's AOQL (Average Outgoing Quality Level).

Note 8: Datasheet min/max specification limits are guaranteed by design, test, or statistical analysis.

Note 9: 10 Ω Terminated input.

External Components Description (Figure 2)

Components	Functional Description
1. R_i	Inverting input resistance which sets the closed-loop gain in conjunction with R_f . This resistor also forms a high-pass filter with C_i at $f_c = 1/(2\pi R_i C_i)$.
2. C_i	Input coupling capacitor which blocks the DC voltage at the amplifier's input terminals. Also creates a high-pass filter with R_i at $f_c = 1/(2\pi R_i C_i)$. Refer to the section Proper Selection of External Components , for an explanation of how to determine the value of C_i .
3. R_f	Feedback resistance which sets the closed-loop gain in conjunction with R_i .
4. C_S	Supply bypass capacitor which provides power supply filtering. Refer to the Power Supply Bypassing section for information concerning proper placement and selection of the supply bypass capacitor.
5. C_B	Bypass pin capacitor which provides half-supply filtering. Refer to the section, Proper Selection of Proper Components , for information concerning proper placement and selection of C_B .
6. C_o	Output coupling capacitor which blocks the DC voltage at the amplifier's output. Forms a high pass filter with R_L at $f_o = 1/(2\pi R_L C_o)$.

Typical Performance Characteristics

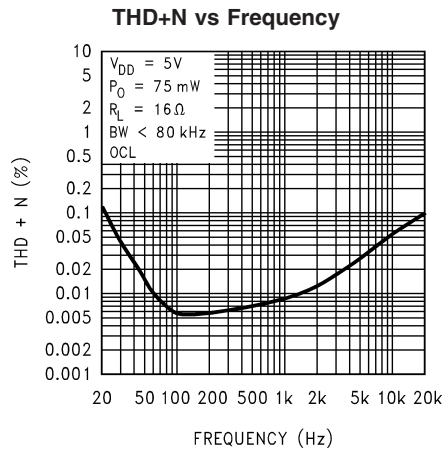

20031482

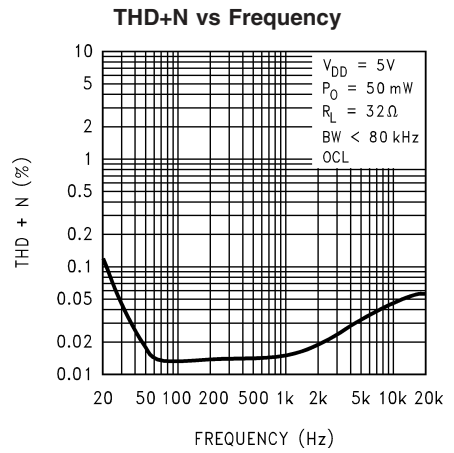

20031483

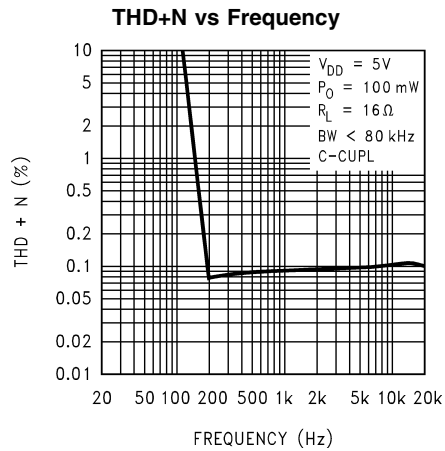

20031484

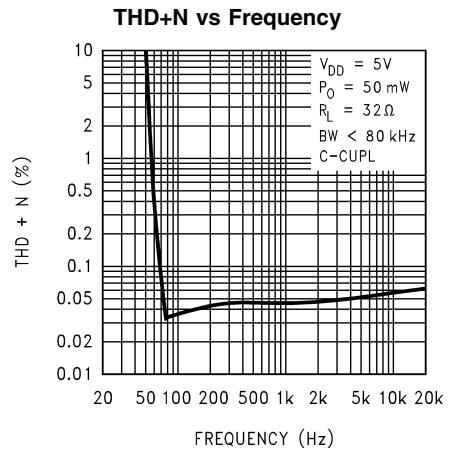

20031485

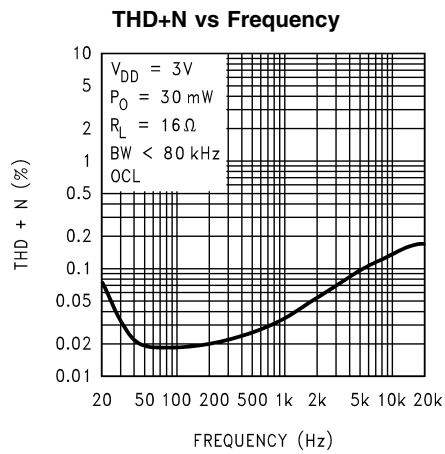

20031406

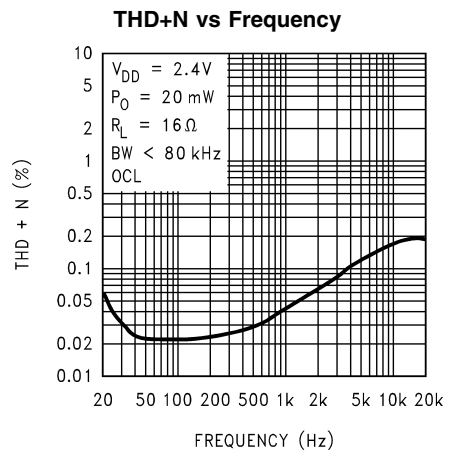

20031403

Typical Performance Characteristics (Continued)

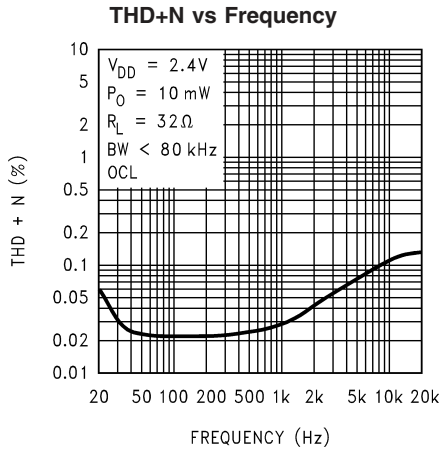

20031405

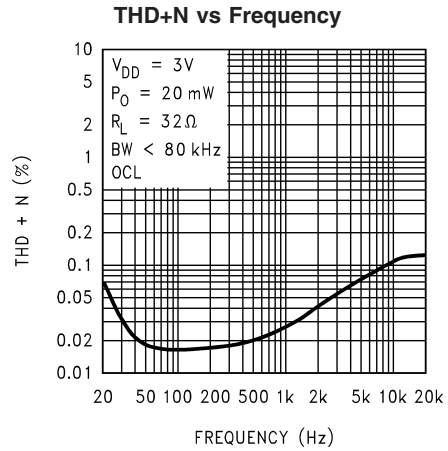

20031404

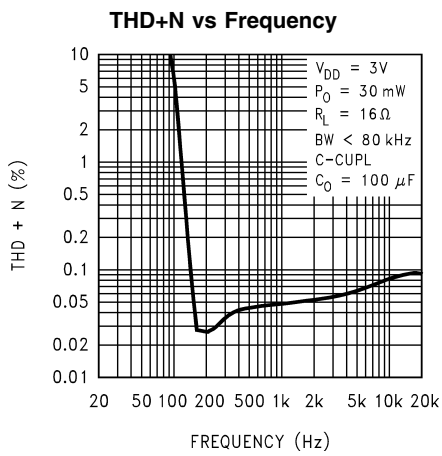

20031486

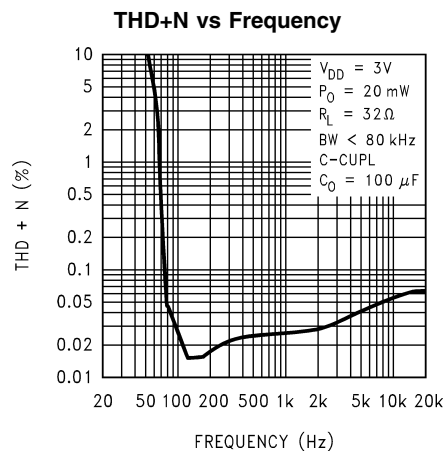

20031487

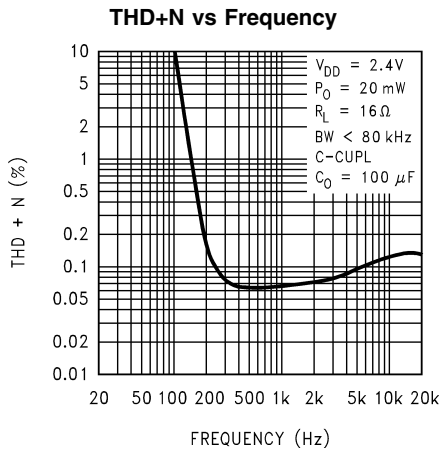

20031488

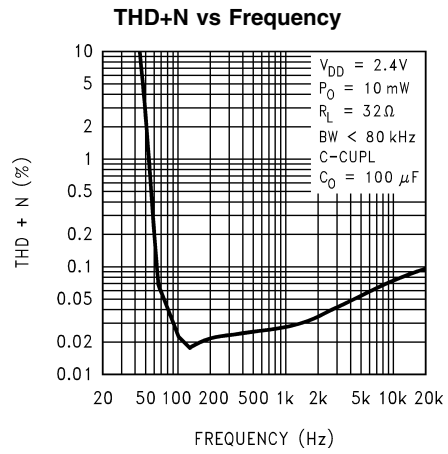

20031489

Typical Performance Characteristics (Continued)

THD+N vs Output Power

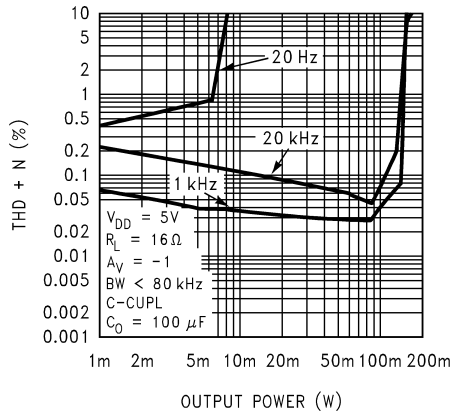

20031490

THD+N vs Output Power

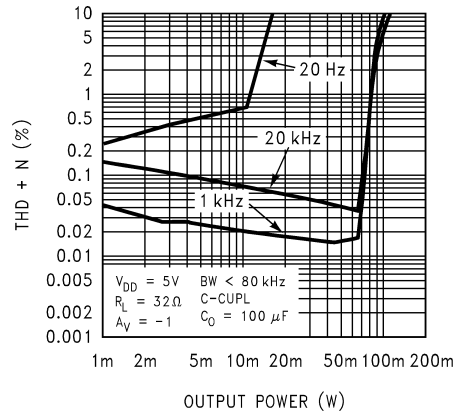

20031491

THD+N vs Output Power

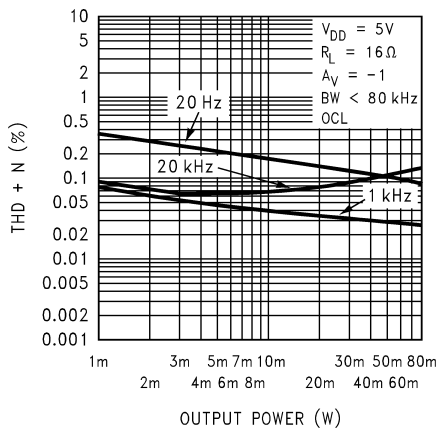

20031492

THD+N vs Output Power

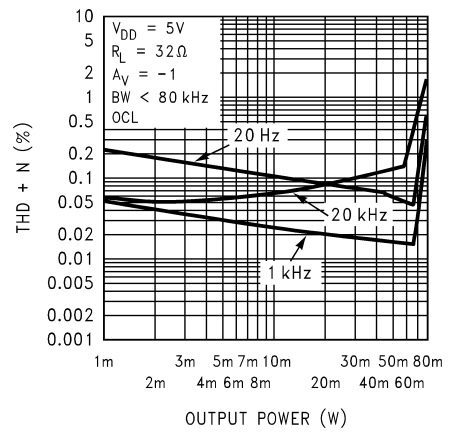

20031493

THD+N vs Output Power

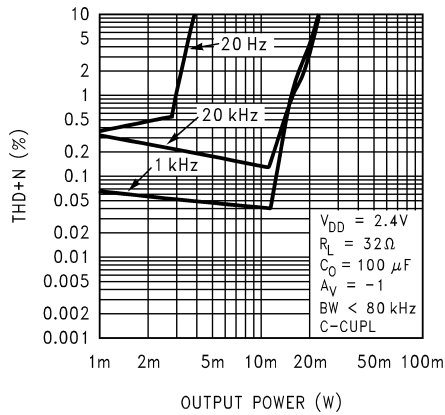

20031408

THD+N vs Output Power

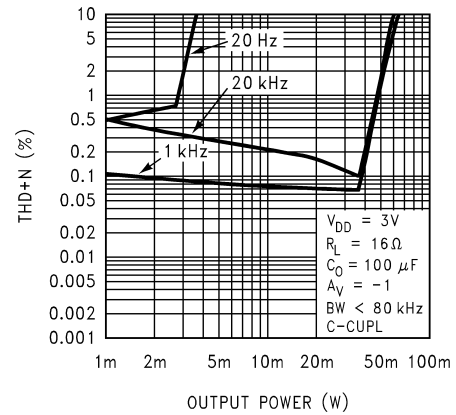

20031407

Typical Performance Characteristics (Continued)

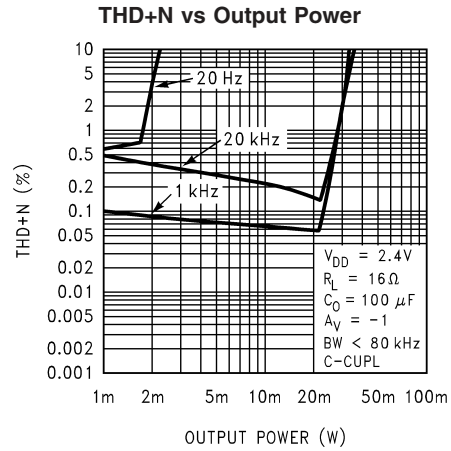
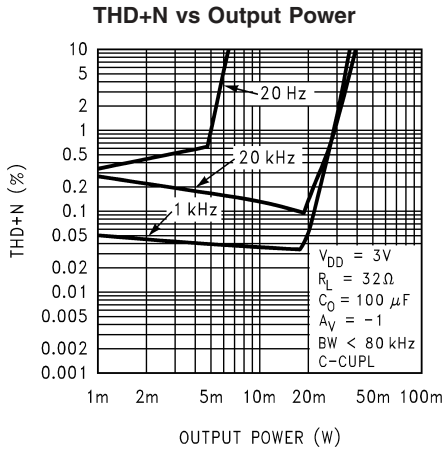

Output Resistance vs Load Resistance

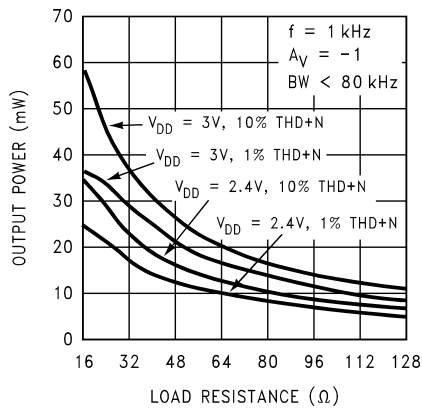

Output Power vs Supply Voltage

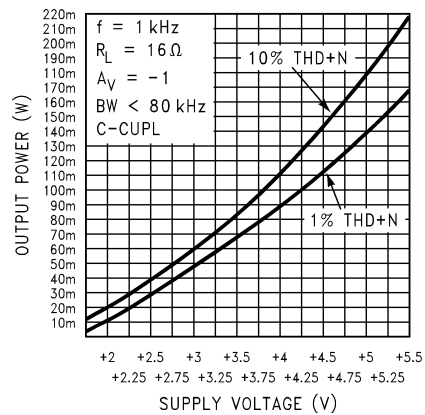

Output Power vs Supply Voltage

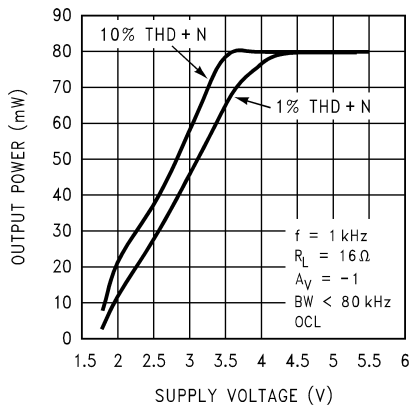

Output Power vs Supply Voltage

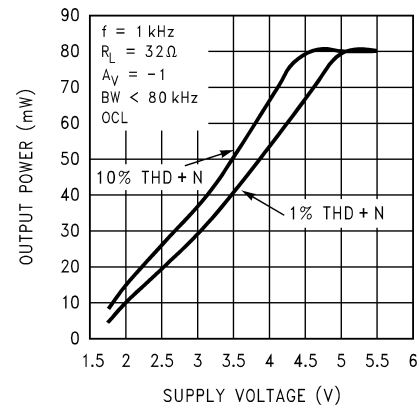

Typical Performance Characteristics (Continued)

Output Power vs Supply Voltage

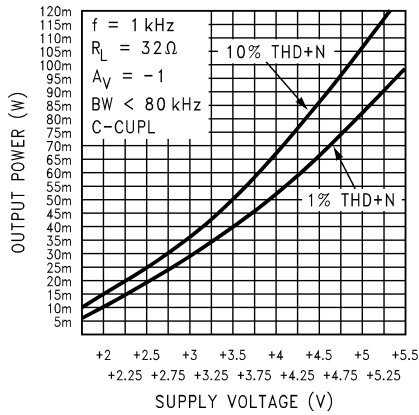

20031411

Output Power vs Load Resistance

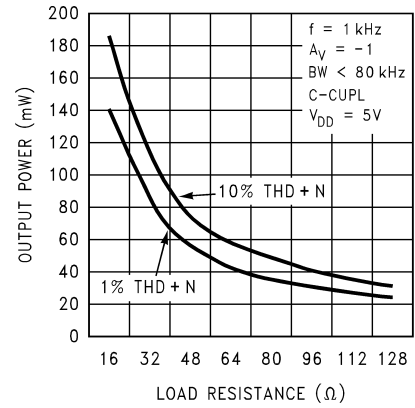

20031496

Output Power vs Load Resistance

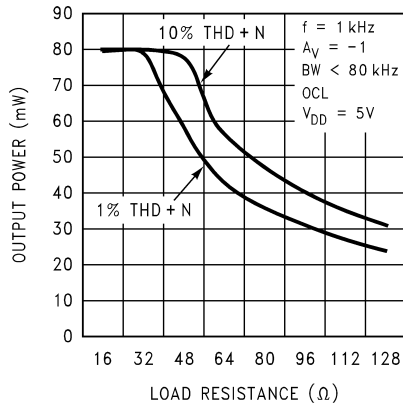

20031497

Power Dissipation vs. Output Power

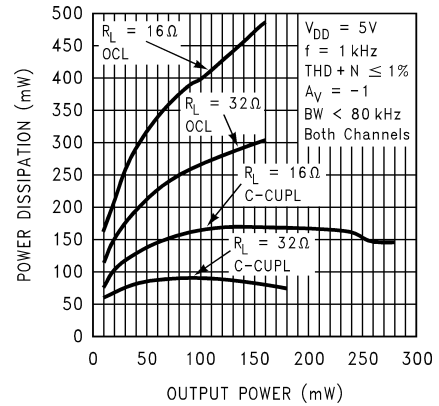

20031498

Power Dissipation vs. Output Power

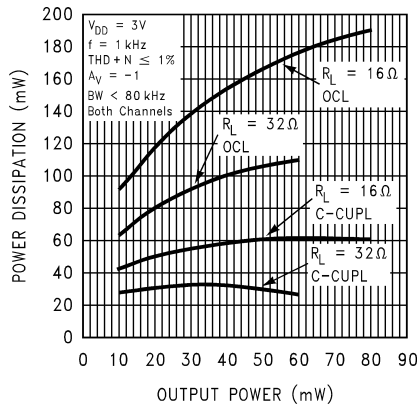

20031499

Power Dissipation vs Output Power

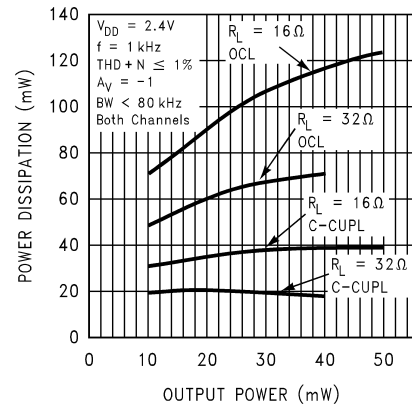

200314A0

Typical Performance Characteristics (Continued)

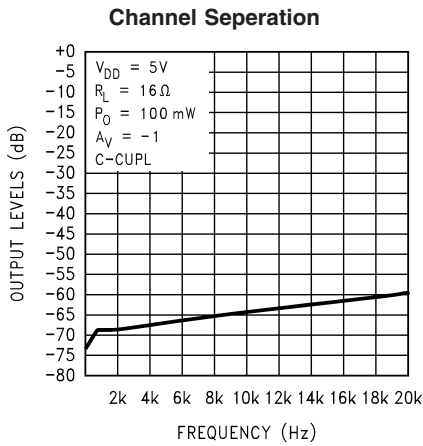

200314A1

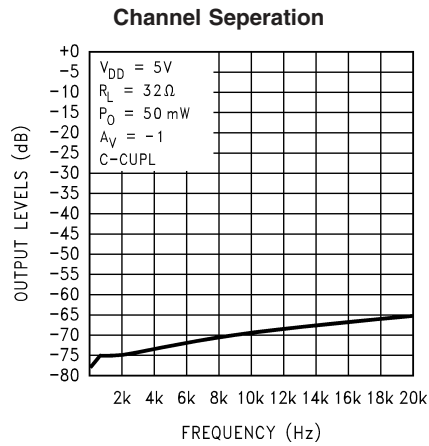

200314A2

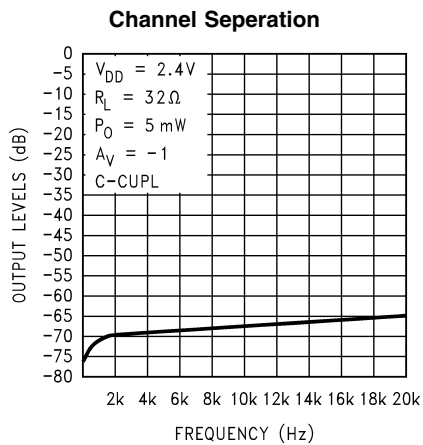

20031417

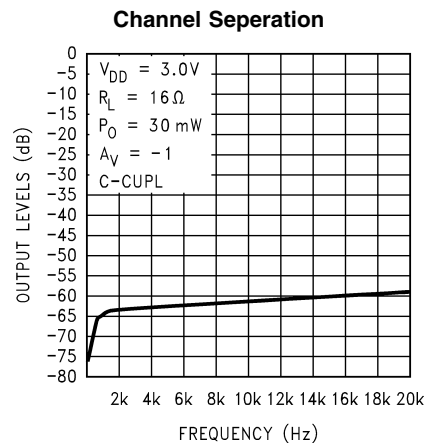

20031419

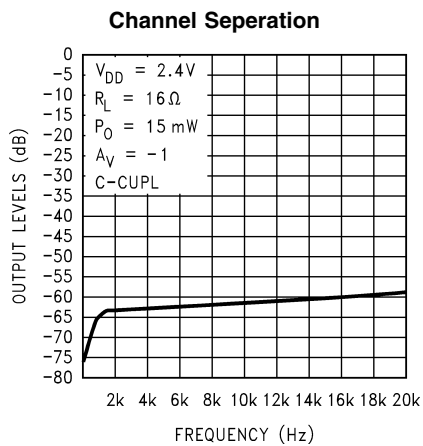

20031418

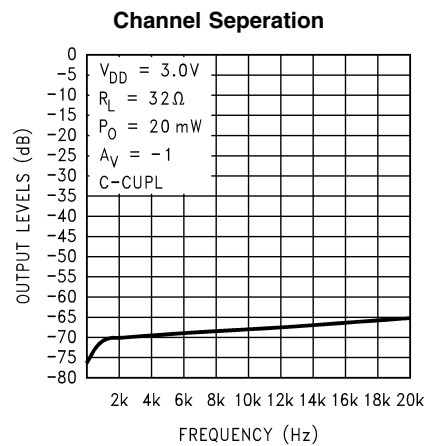

20031416

Typical Performance Characteristics (Continued)

Power Supply Rejection Ratio

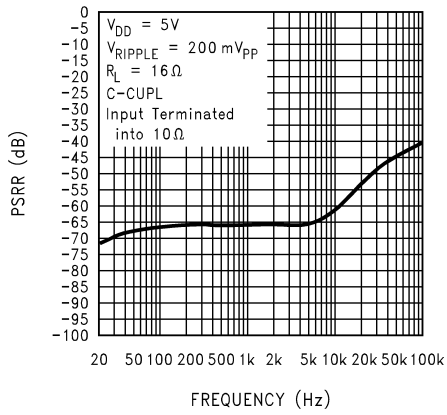

200314A3

Power Supply Rejection Ratio

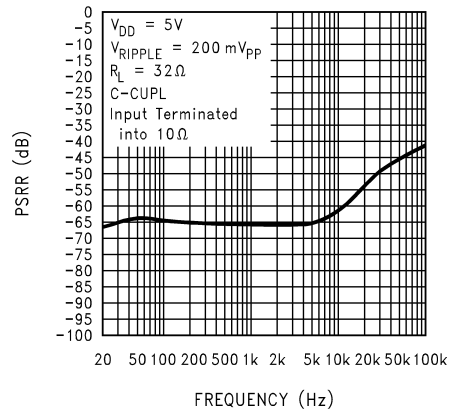

200314A4

Power Supply Rejection Ratio

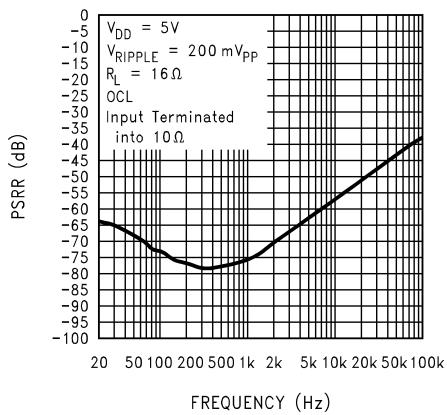

200314A5

Power Supply Rejection Ratio

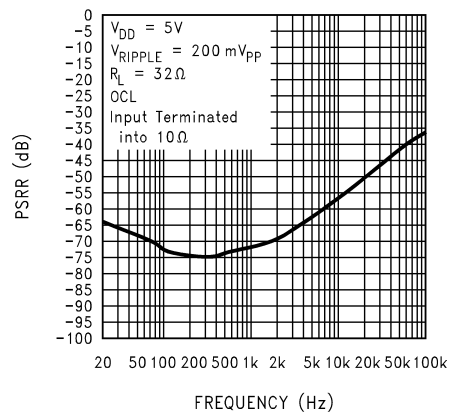

200314A6

Power Supply Rejection Ratio

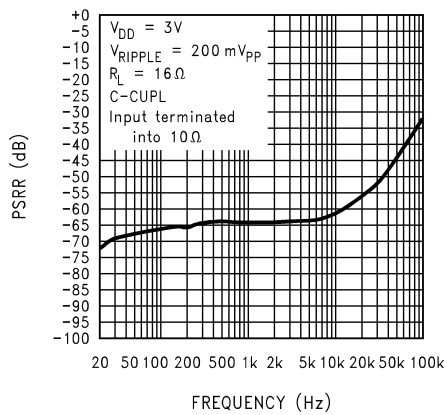

20031420

Power Supply Rejection Ratio

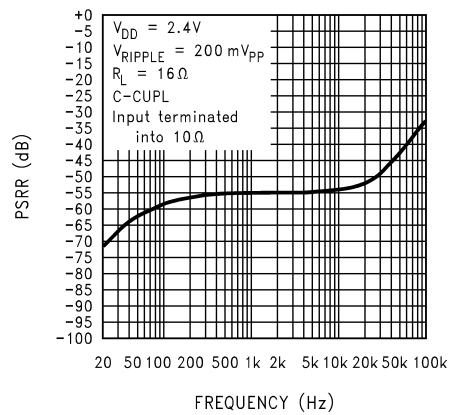

20031423

Typical Performance Characteristics (Continued)

Power Supply Rejection Ratio

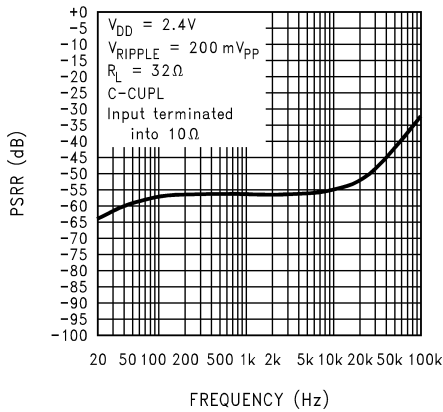

20031421

Power Supply Rejection Ratio

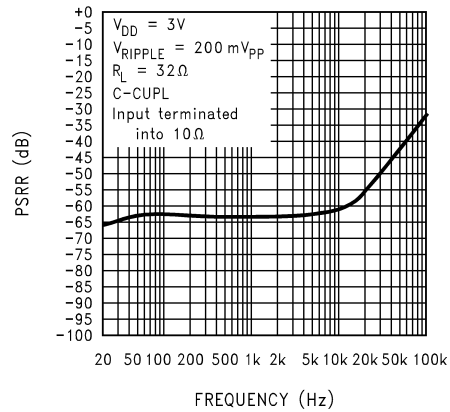

20031422

Frequency Response vs Input Capacitor Size

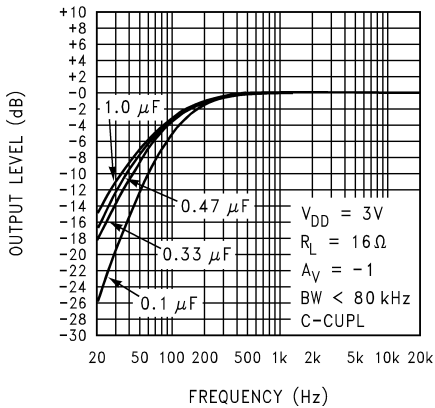

20031427

Frequency Response vs Input Capacitor Size

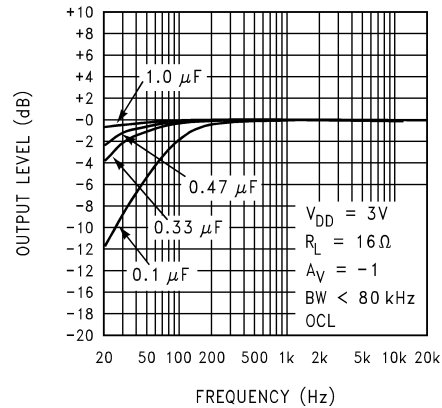

20031426

Open Loop Frequency Response

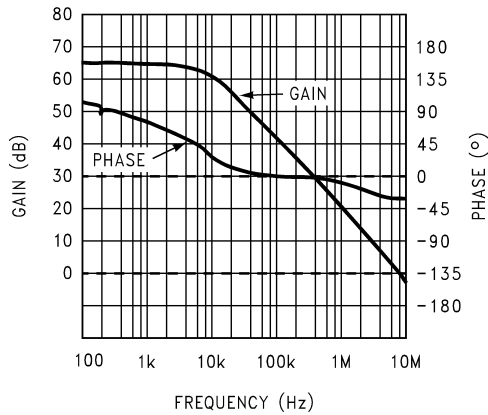

200314A7

Supply Voltage vs Supply Current

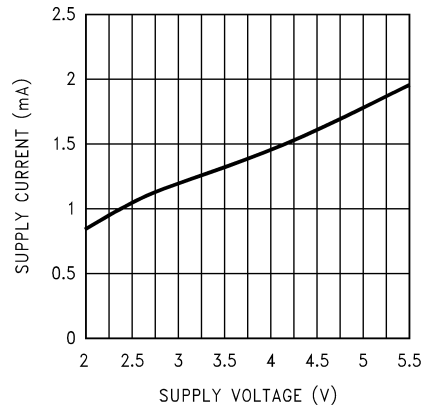

20031424

Typical Performance Characteristics (Continued)

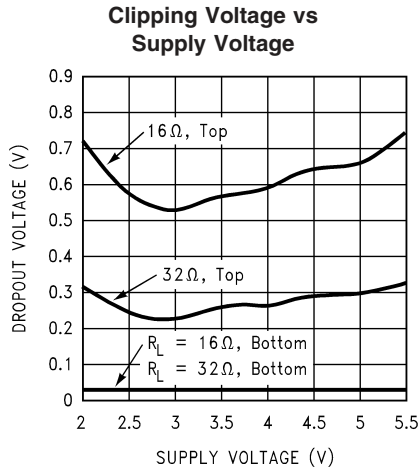

20031425

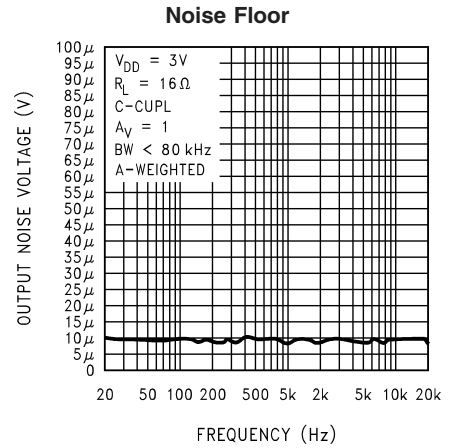

200314A8

Shutdown Hysteresis Voltage, Vdd=5V

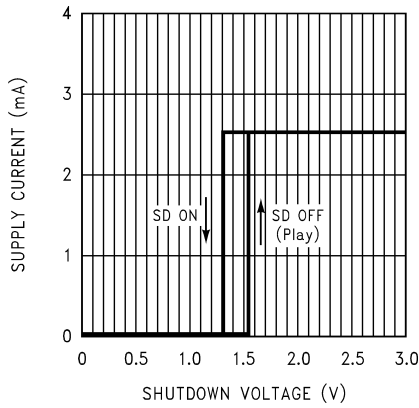

200314B1

Shutdown Hysteresis Voltage, Vdd=3V

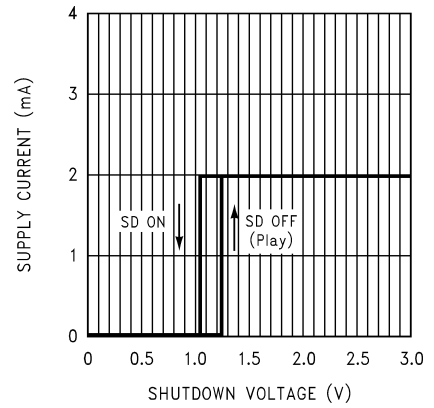

200314B2

Power Derating Curve

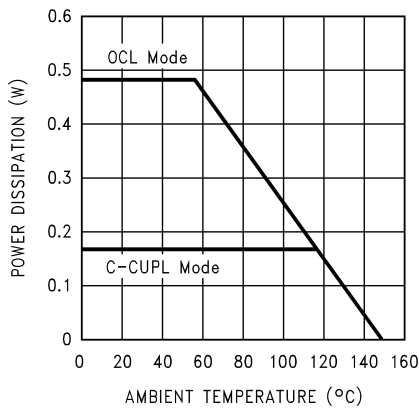

200314B3

Application Information

AMPLIFIER CONFIGURATION EXPLANATION

As shown in Figure 1, the LM4911 has three operational amplifiers internally. Two of the amplifier's have externally configurable gain while the other amplifier is internally fixed at the bias point acting as a unity-gain buffer. The closed-loop gain of the two configurable amplifiers is set by selecting the ratio of R_f to R_i . Consequently, the gain for each channel of the IC is

$$A_{VD} = -(R_f / R_i)$$

By driving the loads through outputs V_{oA} and V_{oB} with V_{oC} acting as a buffered bias voltage the LM4911 does not require output coupling capacitors. The classical single-ended amplifier configuration where one side of the load is connected to ground requires large, expensive output coupling capacitors.

A configuration, such as the one used in the LM4911, has a major advantage over single supply, single-ended amplifiers. Since the outputs V_{oA} , V_{oB} , and V_{oC} are all biased at $1/2 V_{DD}$, no net DC voltage exists across each load. This eliminates the need for output coupling capacitors which are required in a single-supply, single-ended amplifier configuration. Without output coupling capacitors in a typical single-supply, single-ended amplifier, the bias voltage is placed across the load resulting in both increased internal IC power dissipation and possible loudspeaker damage.

OUTPUT CAPACITOR vs. CAPACITOR COUPLED

The LM4911 is a stereo audio power amplifier capable of operating in two distinct output modes: capacitor coupled (C-CUPL) or output capacitor-less (OCL). The LM4911 may be run in capacitor coupled mode by using a coupling capacitor on each single-ended output (V_{oA} and V_{oB}) and connecting V_{oC} to ground. This output coupling capacitor blocks the half supply voltage to which the output amplifiers are typically biased and couples the audio signal to the headphones or other single-ended (SE) load. The signal return to circuit ground is through the headphone jack's sleeve.

The LM4911 can also eliminate these output coupling capacitors by running in OCL mode. Unless shorted to ground, V_{oC} is internally configured to apply a $1/2 V_{DD}$ bias voltage to a stereo headphone jack's sleeve. This voltage matches the bias voltage present on V_{oA} and V_{oB} outputs that drive the headphones. The headphones operate in a manner similar to a bridge-tied load (BTL). Because the same DC voltage is applied to both headphone speaker terminals this results in no net DC current flow through the speaker. AC current flows through a headphone speaker as an audio signal's output amplitude increases on the speaker's terminal.

The headphone jack's sleeve is not connected to circuit ground when used in OCL mode. Using the headphone output jack as a line-level output will place the LM4911's $1/2 V_{DD}$ bias voltage on a plug's sleeve connection. This presents no difficulty when the external equipment uses capacitively coupled inputs. For the very small minority of equipment that is DC coupled, the LM4911 monitors the current supplied by the amplifier that drives the headphone jack's sleeve. If this current exceeds 500mAPK, the amplifier is shutdown, protecting the LM4911 and the external equipment.

POWER DISSIPATION

Power dissipation is a major concern when using any power amplifier and must be thoroughly understood to ensure a successful design. When operating in capacitor-coupled mode, Equation 1 states the maximum power dissipation point for a single-ended amplifier operating at a given supply voltage and driving a specified output load.

$$P_{DMAX} = (V_{DD})^2 / (2\pi^2 R_L) \quad (1)$$

Since the LM4911 has two operational amplifiers in one package, the maximum internal power dissipation point is twice that of the number which results from Equation 1. From Equation 1, assuming a 3V power supply and an 32Ω load, the maximum power dissipation point is 14mW per amplifier. Thus the maximum package dissipation point is 28mW.

When operating in OCL mode, the maximum power dissipation increases due to the use of the third amplifier as a buffer and is given in Equation 2:

$$P_{DMAX} = 4(V_{DD})^2 / (\pi^2 R_L) \quad (2)$$

The maximum power dissipation point obtained from either Equation 1 or 2 must not be greater than the power dissipation that results from Equation 3:

$$P_{DMAX} = (T_{JMAX} - T_A) / \theta_{JA} \quad (3)$$

For package MUB10A, $\theta_{JA} = 190^\circ\text{C/W}$. $T_{JMAX} = 150^\circ\text{C}$ for the LM4911. Depending on the ambient temperature, T_A , of the system surroundings, Equation 3 can be used to find the maximum internal power dissipation supported by the IC packaging. If the result of Equation 1 or 2 is greater than that of Equation 3, then either the supply voltage must be decreased, the load impedance increased or T_A reduced. For the typical application of a 3V power supply, with an 32Ω load, the maximum ambient temperature possible without violating the maximum junction temperature is approximately 144°C provided that device operation is around the maximum power dissipation point. Thus, for typical applications, power dissipation is not an issue. Power dissipation is a function of output power and thus, if typical operation is not around the maximum power dissipation point, the ambient temperature may be increased accordingly. Refer to the Typical Performance Characteristics curves for power dissipation information for lower output powers.

POWER SUPPLY BYPASSING

As with any amplifier, proper supply bypassing is important for low noise performance and high power supply rejection. The capacitor location on the power supply pins should be as close to the device as possible.

Typical applications employ a 3V regulator with 10mF tantalum or electrolytic capacitor and a ceramic bypass capacitor which aid in supply stability. This does not eliminate the need for bypassing the supply nodes of the LM4911. A bypass capacitor value in the range of $0.1\mu\text{F}$ to $1\mu\text{F}$ is recommended for C_S .

Application Information (Continued)

MICRO POWER SHUTDOWN

The voltage applied to the SHUTDOWN pin controls the LM4911's shutdown function. Activate micro-power shutdown by applying a logic-low voltage to the SHUTDOWN pin. When active, the LM4911's micro-power shutdown feature turns off the amplifier's bias circuitry, reducing the supply current. The trigger point varies depending on supply voltage and is shown in the Shutdown Hysteresis Voltage graphs in the Typical Performance Characteristics section. The low 0.1 μ A(typ) shutdown current is achieved by applying a voltage that is as near as ground as possible to the SHUTDOWN pin. A voltage that is higher than ground may increase the shutdown current. There are a few ways to control the micro-power shutdown. These include using a single-pole, single-throw switch, a microprocessor, or a microcontroller. When using a switch, connect an external 100k Ω pull-up resistor between the SHUTDOWN pin and V_{DD} . Connect the switch between the SHUTDOWN pin and ground. Select normal amplifier operation by opening the switch. Closing the switch connects the SHUTDOWN pin to ground, activating micro-power shutdown.

The switch and resistor guarantee that the SHUTDOWN pin will not float. This prevents unwanted state changes. In a system with a microprocessor or microcontroller, use a digital output to apply the control voltage to the SHUTDOWN pin. Driving the SHUTDOWN pin with active circuitry eliminates the pull-up resistor.

Shutdown enable/disable times are controlled by a combination of C_B and V_{DD} . Larger values of C_B results in longer turn on/off times from Shutdown. Smaller V_{DD} values also increase turn on/off time for a given value of C_B . Longer shutdown times also improve the LM4911's resistance to click and pop upon entering or returning from shutdown. For a 2.4V supply and $C_B = 4.7\mu$ F, the LM4911 requires about 2 seconds to enter or return from shutdown. This longer shutdown time enables the LM4911 to have virtually zero pop and click transients upon entering or release from shutdown. Smaller values of C_B will decrease turn-on time, but at the cost of increased pop and click and reduced PSRR. Since shutdown enable/disable times increase dramatically as supply voltage gets below 2.2V, this reduced turn-on time may be desirable if extreme low supply voltage levels are used as this would offset increases in turn-on time caused by the lower supply voltage. This technique is not recommended for OCL mode since shutdown enable/disable times are very fast (0.5s) independent of supply voltage.

MUTE

When in C-CUPL mode, the LM4911 also features a mute function that enables extremely fast turn-on/turn-off with a minimum of output pop and click with a low current consumption ($\leq 100\mu$ A). The mute function leaves the outputs at their bias level, thus resulting in higher power consumption than shutdown mode, but also provides much faster turn on/off times. Mute mode is enabled by providing a logic high signal on the MUTE pin in the opposite manner as the shutdown function described above. Threshold voltages and activation techniques match those given for the shutdown function as well.

The mute function is not necessary when the LM4911 is operating in OCL mode since the shutdown function operates quickly in OCL mode with less power consumption than mute.

Additionally, Mute should not be enabled during shutdown or while entering or returning from shutdown. This is not a valid operation condition and may result in much higher pop and click values.

PROPER SELECTION OF EXTERNAL COMPONENTS

Proper selection of external components in applications using integrated power amplifiers is critical to optimize device and system performance. While the LM4911 is tolerant of external component combinations, consideration to component values must be used to maximize overall system quality.

The LM4911 is unity-gain stable which gives the designer maximum system flexibility. The LM4911 should be used in low gain configurations to minimize THD+N values, and maximize the signal to noise ratio. Low gain configurations require large input signals to obtain a given output power. Input signals equal to or greater than 1V_{rms} are available from sources such as audio codecs. Very large values should not be used for the gain-setting resistors. Values for R_i and R_f should be less than 1M Ω . Please refer to the section, **Audio Power Amplifier Design**, for a more complete explanation of proper gain selection

Besides gain, one of the major considerations is the closed-loop bandwidth of the amplifier. To a large extent, the bandwidth is dictated by the choice of external components shown in Figures 2 and 3. The input coupling capacitor, C_i , forms a first order high pass filter which limits low frequency response. This value should be chosen based on needed frequency response and turn-on time.

SELECTION OF INPUT CAPACITOR SIZE

Amplifying the lowest audio frequencies requires a high value input coupling capacitor, C_i . A high value capacitor can be expensive and may compromise space efficiency in portable designs. In many cases, however, the headphones used in portable systems have little ability to reproduce signals below 60Hz. Applications using headphones with this limited frequency response reap little improvement by using a high value input capacitor.

In addition to system cost and size, turn on time is affected by the size of the input coupling capacitor C_i . A larger input coupling capacitor requires more charge to reach its quiescent DC voltage. This charge comes from the output via the feedback. Thus, by minimizing the capacitor size based on necessary low frequency response, turn-on time can be minimized. A small value of C_i (in the range of 0.1 μ F to 0.39 μ F), is recommended.

AUDIO POWER AMPLIFIER DESIGN

A 25mW/32 Ω Audio Amplifier

Given:	
Power Output	25mWrms
Load Impedance	32 Ω
Input Level	1Vrms
Input Impedance	20k Ω

A designer must first determine the minimum supply rail to obtain the specified output power. By extrapolating from the Output Power vs Supply Voltage graphs in the **Typical Performance Characteristics** section, the supply rail can be easily found.

3V is a standard voltage in most applications, it is chosen for the supply rail. Extra supply voltage creates headroom that

Application Information (Continued)

allows the LM4911 to reproduce peak in excess of 25mW without producing audible distortion. At this time, the designer must make sure that the power supply choice along with the output impedance does not violate the conditions explained in the **Power Dissipation** section.

Once the power dissipation equations have been addressed, the required gain can be determined from Equation 2.

$$A_V \geq \sqrt{(P_O R_L) / (V_{IN})} = V_{orms} / V_{inrms} \quad (4)$$

From Equation 4, the minimum A_V is 0.89; use $A_V = 1$. Since the desired input impedance is $20k\Omega$, and with a A_V gain of 1, a ratio of 1:1 results from Equation 1 for R_f to R_i . The values are chosen with $R_i = 20k\Omega$ and $R_f = 20k\Omega$. The final design step is to address the bandwidth requirements which must be stated as a pair of -3dB frequency points. Five times away from a -3dB point is 0.17dB down from passband response which is better than the required ± 0.25 dB specified.

$$f_L = 100\text{Hz} / 5 = 20\text{Hz}$$

$$f_H = 20\text{kHz} * 5 = 100\text{kHz}$$

As stated in the **External Components** section, R_i in conjunction with C_i creates a

$$C_i \geq 1 / (2\pi * 20k\Omega * 20\text{Hz}) = 0.397\mu\text{F}; \text{ use } 0.39\mu\text{F}.$$

The high frequency pole is determined by the product of the desired frequency pole, f_H , and the differential gain, A_V . With an $A_V = 1$ and $f_H = 100\text{kHz}$, the resulting GBWP = 100kHz which is much smaller than the LM4911 GBWP of 10MHz . This figure displays that a designer has a need to design an amplifier with higher differential gain, the LM4911 can still be used without running into bandwidth limitations.

Figure 4 shows an optional resistor connected between the amplifier output that drives the headphone jack sleeve and ground. This resistor provides a ground path that suppressed power supply hum. This hum may occur in applications such as notebook computers in a shutdown condition and connected to an external powered speaker. The resistor's 100Ω value is a suggested starting point. Its final value must be determined based on the tradeoff between the amount of noise suppression that may be needed and minimizing the additional current drawn by the resistor (25mA for a 100Ω resistor and a 5V supply).

ESD PROTECTION

As stated in the Absolute Maximum Ratings, the LM4911 has a maximum ESD susceptibility rating of 2000V . For higher ESD voltages, the addition of a PCDN042 dual transil (from California Micro Devices), as shown in Figure 4, will provide additional protection.

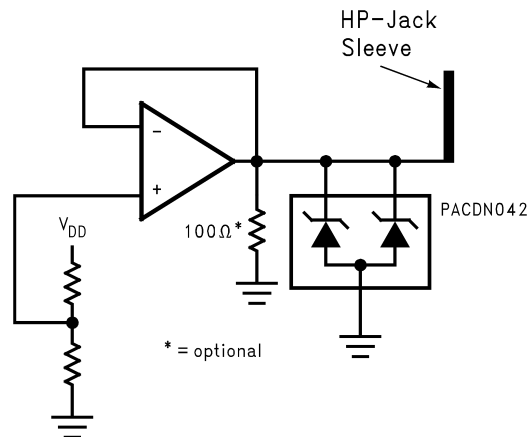

200314B4

Figure 4. The PCDN042 provides additional ESD protection beyond the 2000V shown in the Absolute Maximum Ratings for the V_{OC} output

Physical Dimensions inches (millimeters) unless otherwise noted

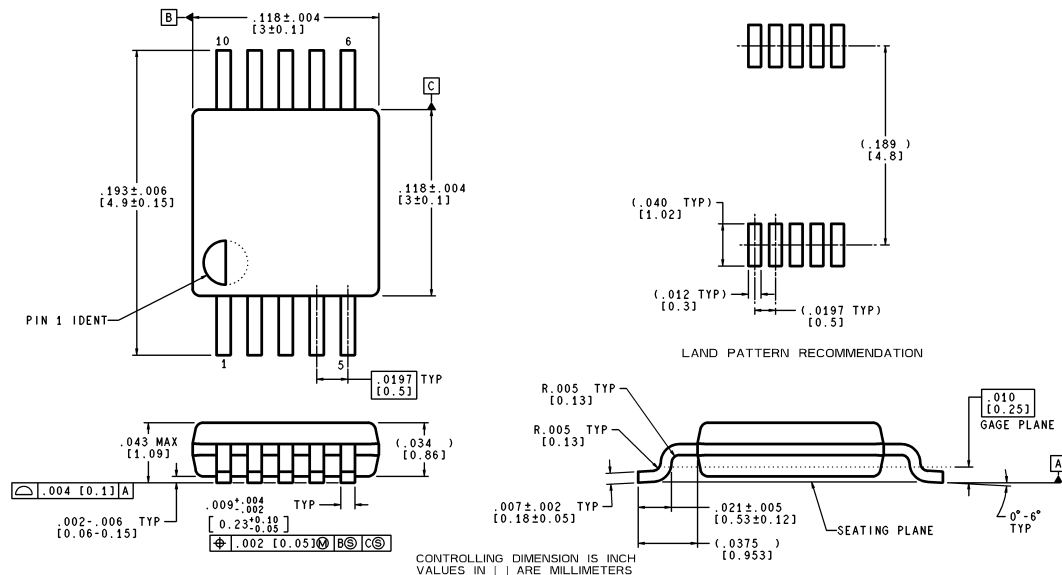

MUB10A (Rev A)

MSOP
Order Number LM4911MM
NS Package Number MUB10A

LIFE SUPPORT POLICY

NATIONAL'S PRODUCTS ARE NOT AUTHORIZED FOR USE AS CRITICAL COMPONENTS IN LIFE SUPPORT DEVICES OR SYSTEMS WITHOUT THE EXPRESS WRITTEN APPROVAL OF THE PRESIDENT AND GENERAL COUNSEL OF NATIONAL SEMICONDUCTOR CORPORATION. As used herein:

1. Life support devices or systems are devices or systems which, (a) are intended for surgical implant into the body, or (b) support or sustain life, and whose failure to perform when properly used in accordance with instructions for use provided in the labeling, can be reasonably expected to result in a significant injury to the user.
2. A critical component is any component of a life support device or system whose failure to perform can be reasonably expected to cause the failure of the life support device or system, or to affect its safety or effectiveness.



National Semiconductor Corporation
Americas
Email: support@nsc.com

www.national.com

National Semiconductor Europe
Fax: +49 (0) 180-530 85 86
Email: europe.support@nsc.com
Deutsch Tel: +49 (0) 69 9508 6208
English Tel: +44 (0) 870 24 0 2171
Français Tel: +33 (0) 1 41 91 8790

National Semiconductor Asia Pacific Customer Response Group
Tel: 65-2544466
Fax: 65-2504466
Email: ap.support@nsc.com

National Semiconductor Japan Ltd.
Tel: 81-3-5639-7560
Fax: 81-3-5639-7507