

LM612

Dual-Channel Comparator and Reference

General Description

The dual-channel comparator consists of two individual comparators, having an input voltage range that extends down to the negative supply voltage V^- . The common open-collector output can be driven low by either half of the LM612. This configuration makes the LM612 ideal for use as a window comparator. The input stages of the comparator have lateral PNP input transistors which maintain low input currents for large differential input voltages and swings above V^+ .

The 1.2V voltage reference, referred to the V^- terminal, is a two-terminal shunt-type band-gap similar to the LM185-1.2 series, with voltage accuracy of $\pm 0.6\%$ available. The reference features operation over a shunt current range of $17 \mu\text{A}$ to 20 mA, low dynamic impedance, and broad capacitive load range.

As a member of National's Super-Block™ family, the LM612 is a space-saving monolithic alternative to a multi-chip solution, offering a high level of integration without sacrificing performance.

Features

COMPARATORS

- Low operating current 300 μA
- Wide supply voltage range 4V to 36V
- Open-collector outputs
- Input common-mode range V^- to $(V^+ - 1.8\text{V})$
- Wide differential input voltage $\pm 36\text{V}$

REFERENCE

- Fixed output voltage 1.24V
- Tight initial tolerance available $\pm 0.6\%$ (25°C)
- Wide operating current range 17 μA to 20 mA
- Tolerant of load capacitance

Applications

- Voltage window comparator
- Power supply voltage monitor
- Dual-channel fault monitor

Connection Diagram

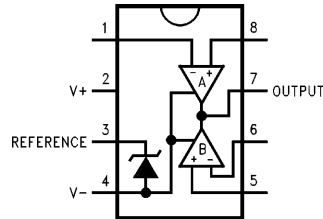

Top View

TL/H/11058-1

Ordering Information

For information about surface-mount packaging of this device, please contact the Analog Product Marketing group at National Semiconductor Corporation headquarters.

Reference Tolerances	Temperature Range		Package	NSC Package Number
	Military $-55^\circ\text{C} \leq T_J \leq +125^\circ\text{C}$	Industrial $-40^\circ\text{C} \leq T_J \leq +85^\circ\text{C}$		
$\pm 0.6\%$ at 25°C, 80 ppm/°C Max	LM612AMN	LM612AIN	8-Pin Molded DIP	N08E
	LM612AMJ/883 (Note 13)		8-Pin Ceramic DIP	J08A
$\pm 2.0\%$ at 25°C, 150 ppm/°C Max	LM612MN	LM612IN	8-Pin Molded DIP	N08E
		LM612IM	8-Pin Narrow Surface Mount	M08A

Super-Block™ is a trademark of National Semiconductor Corporation.

Absolute Maximum Ratings (Note 1)

If Military/Aerospace specified devices are required, please contact the National Semiconductor Sales Office/Distributors for availability and specifications.

Voltage on Any Pin Except V_R (referred to V^- pin) (Note 2)	36V (Max)
(Note 3)	-0.3V (Min)
Current through Any Input Pin and V_R Pin	± 20 mA
Differential Input Voltage	± 36 V
Output Short-Circuit Duration	(Note 4)
Storage Temperature Range	$-65^\circ\text{C} \leq T_J \leq +150^\circ\text{C}$
Maximum Junction Temperature	150°C

Thermal Resistance, Junction-to-Ambient (Note 5)
N Package $100^\circ\text{C}/\text{W}$

Soldering Information
N Package
Soldering (10 seconds) 260°C
ESD Tolerance (Note 6) ± 1 kV

Operating Temperature Range

LM612AI, LM612I $-40^\circ\text{C} \leq T_J \leq +85^\circ\text{C}$
LM612AM, LM612M $-55^\circ\text{C} \leq T_J \leq +125^\circ\text{C}$

Electrical Characteristics These specifications apply for $V^- = \text{GND} = 0\text{V}$, $V^+ = 5\text{V}$, $V_{\text{CM}} = V_{\text{OUT}} = V^+ / 2$, $I_R = 100 \mu\text{A}$, unless otherwise specified. Limits in standard typeface are for $T_J = 25^\circ\text{C}$; limits in **boldface type** apply over the **Operating Temperature Range**.

Symbol	Parameter	Conditions	Typical (Note 7)	LM612AM LM612AI Limits (Note 8)	LM612M LM612I Limits (Note 8)	Units
COMPARATORS						
I_S	Total Supply Current	V^+ Current, $R_{\text{LOAD}} = \infty$, $3\text{V} \leq V^+ \leq 36\text{V}$	150 170	250 300	250 300	μA Max μA Max
V_{OS}	Offset Voltage over V^+ Range	$4\text{V} \leq V^+ \leq 36\text{V}$, $R_L = 15 \text{ k}\Omega$	1.0 2.0	3.0 6.0	5.0 7.0	mV Max mV Max
V_{OS}	Offset Voltage over V_{CM} Range	$0\text{V} \leq V_{\text{CM}} \leq (V^+ - 1.8\text{V})$ $V^+ = 30\text{V}$, $R_L = 15 \text{ k}\Omega$	1.0 1.5	3.0 6.0	5.0 7.0	mV Max mV Max
$\frac{\Delta V_{\text{OS}}}{\Delta T}$	Average Offset Voltage Drift		15			$\mu\text{V}/^\circ\text{C}$
I_B	Input Bias Current		5 8	25 30	35 40	nA Max nA Max
I_{OS}	Input Offset Current		0.2 0.3	4 5	4 5	nA Max nA Max
A_V	Voltage Gain	$R_L = 10 \text{ k}\Omega$ to 36V , $2\text{V} \leq V_{\text{OUT}} \leq 27\text{V}$	500 100	50	50	V/mV Min V/mV
t_R	Large Signal Response Time	$V_{+\text{IN}} = 1.4\text{V}$, $V_{-\text{IN}} = \text{TTL}$ Swing, $R_L = 5.1 \text{ k}\Omega$	1.5 2.0			μs μs
I_{SINK}	Output Sink Current	$V_{+\text{IN}} = 0\text{V}$, $V_{-\text{IN}} = 1\text{V}$, $V_{\text{OUT}} = 1.5\text{V}$ $V_{\text{OUT}} = 0.4\text{V}$	20 13 2.8 2.4	10 8 1.0 0.5	10 8 0.8 0.5	mA Min mA Min mA Min mA Min
I_L	Output Leakage Current	$V_{+\text{IN}} = 1\text{V}$, $V_{-\text{IN}} = 0\text{V}$, $V_{\text{OUT}} = 36\text{V}$	0.1 0.2	10	10	μA Max μA

Electrical Characteristics These specifications apply for $V^- = \text{GND} = 0\text{V}$, $V^+ = 5\text{V}$, $V_{\text{CM}} = V_{\text{OUT}} = V^+ / 2$, $I_{\text{R}} = 100 \mu\text{A}$, unless otherwise specified. Limits in standard typeface are for $T_{\text{J}} = 25^\circ\text{C}$; limits in **boldface type** apply over the **Operating Temperature Range**. (Continued)

Symbol	Parameter	Conditions	Typical (Note 7)	LM612AM LM612AI Limits (Note 8)	LM612M LM612I Limits (Note 8)	Units
VOLTAGE REFERENCE (Note 9)						
V_{R}	Reference Voltage		1.244	1.2365 1.2515 ($\pm 0.6\%$)	1.2191 1.2689 ($\pm 2\%$)	V Min V Max
$\frac{\Delta V_{\text{R}}}{\Delta T}$	Average Drift with Temperature	(Note 10)	18	80	150	ppm/ $^\circ\text{C}$ Max
$\frac{\Delta V_{\text{R}}}{\text{kH}}$	Average Drift with Time	$T_{\text{J}} = 40^\circ\text{C}$ $T_{\text{J}} = 150^\circ\text{C}$	400 1000			ppm/kH ppm/kH
$\frac{\Delta V_{\text{R}}}{\Delta T_{\text{J}}}$	Hysteresis	(Note 11)	3.2			$\mu\text{V}/^\circ\text{C}$
$\frac{\Delta V_{\text{R}}}{\Delta I_{\text{R}}}$	V_{R} Change with Current	$V_{\text{R}}[100 \mu\text{A}] - V_{\text{R}}[17 \mu\text{A}]$	0.05 0.1	1 1.1	1 1.1	mV Max mV Max
		$V_{\text{R}}[10 \text{mA}] - V_{\text{R}}[100 \mu\text{A}]$ (Note 12)	1.5 2.0	5 5.5	5 5.5	mV Max mV Max
R	Resistance	$\Delta V_{\text{R}}[10 \text{mA to } 0.1 \text{mA}] / 9.9 \text{mA}$	0.2	0.56	0.56	Ω Max
		$\Delta V_{\text{R}}[100 \mu\text{A to } 17 \mu\text{A}] / 83 \mu\text{A}$	0.6	13	13	Ω Max
$\frac{\Delta V_{\text{R}}}{\Delta V^+}$	V_{R} Change with V^+ Change	$V_{\text{R}}[V^+ = 5\text{V}] - V_{\text{R}}[V^+ = 36\text{V}]$	0.1 0.1	1.2 1.3	1.2 1.3	mV Max mV Max
		$V_{\text{R}}[V^+ = 5\text{V}] - V_{\text{R}}[V^+ = 3\text{V}]$	0.01 0.01	1 1.5	1 1.5	mV Max mV Max
e_{n}	Voltage Noise	BW = 10 Hz to 10 kHz	30			μVRMS

Note 1: Absolute maximum ratings indicate limits beyond which damage to the component may occur. Electrical specifications do not apply when operating the device beyond its rated operating conditions.

Note 2: Input voltage above V^+ is not allowed. As long as one input pin voltage remains inside the common-mode range, the comparator will deliver the correct output.

Note 3: More accurately, it is excessive current flow, with resulting excess heating, that limits the voltages on all pins. When any pin is pulled a diode drop below V^- , a parasitic NPN transistor turns ON. No latch-up will occur as long as the current through that pin remains below the Maximum Rating. Operation is undefined and unpredictable when any parasitic diode or transistor is conducting.

Note 4: Shorting the Output to V^- will not cause power dissipation, so it may be continuous. However, shorting the Output to any more positive voltage (including V^+), will cause 80 mA (typ.) to be drawn through the output transistor. This current multiplied by the applied voltage is the power dissipation in the output transistor. If this total power causes the junction temperature to exceed 150°C , degraded reliability or destruction of the device may occur. To determine junction temperature, see Note 5.

Note 5: Junction temperature may be calculated using $T_{\text{J}} = T_{\text{A}} + P_{\text{D}} \theta_{\text{JA}}$. The given thermal resistance is worst-case for packages in sockets in still air. For packages soldered to copper-clad board with dissipation from one comparator or reference output transistor, nominal θ_{JA} is $90^\circ\text{C}/\text{W}$ for the N package.

Note 6: Human body model, 100 pF discharged through a 1.5 k Ω resistor.

Note 7: Typical values in standard typeface are for $T_{\text{J}} = 25^\circ\text{C}$; values in **boldface type** apply for the full operating temperature range. These values represent the most likely parametric norm.

Note 8: All limits are guaranteed for $T_{\text{J}} = 25^\circ\text{C}$ (standard type face) or over the full operating temperature range (**bold type face**).

Note 9: V_{R} is the reference output voltage, nominally 1.24V.

Note 10: Average reference drift is calculated from the measurement of the reference voltage at 25°C and at the temperature extremes. The drift, in ppm/ $^\circ\text{C}$, is $10^6 \cdot \Delta V_{\text{R}} / V_{\text{R}}[25^\circ\text{C}] \cdot \Delta T_{\text{J}}$, where ΔV_{R} is the lowest value subtracted from the highest, $V_{\text{R}}[25^\circ\text{C}]$ is the value at 25°C , and ΔT_{J} is the temperature range. This parameter is guaranteed by design and sample testing.

Note 11: Hysteresis is the change in V_{R} caused by a change in T_{J} , after the reference has been "dehysteresized". To dehysteresize the reference; that is minimize the hysteresis to the typical value, its junction temperature should be cycled in the following pattern, spiraling in toward 25°C : 25°C , 85°C , -40°C , 70°C , 0°C , 25°C .

Note 12: Low contact resistance is required for accurate measurement.

Note 13: A military RETS 612AMX electrical test specification is available on request. The military screened parts can also be procured as a Standard Military Drawing.

Simplified Schematic Diagrams

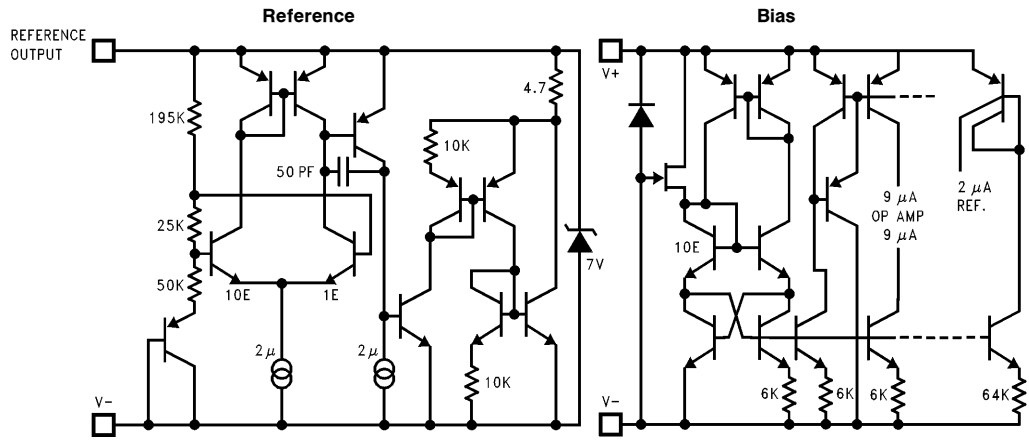
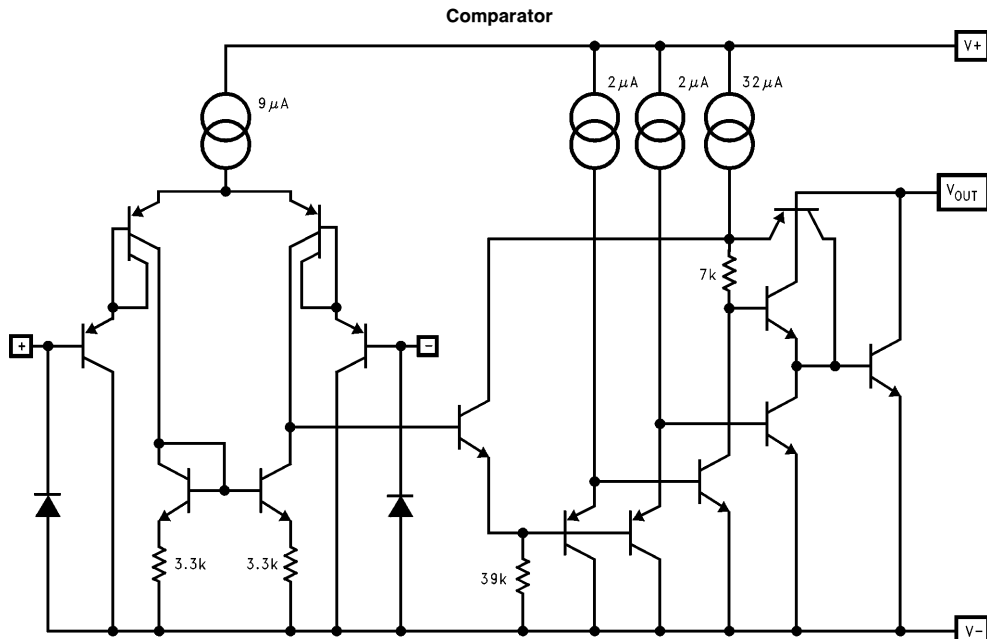

Typical Performance Characteristics (Reference)

$T_J = 25^\circ\text{C}$, $V^- = 0\text{V}$, unless otherwise noted

Reference Voltage vs Temp.

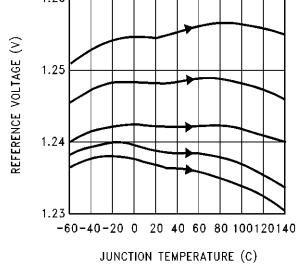

Reference Voltage Drift vs Time

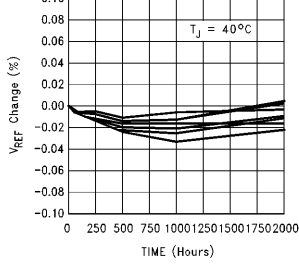

Accelerated Reference Voltage Drift vs Time

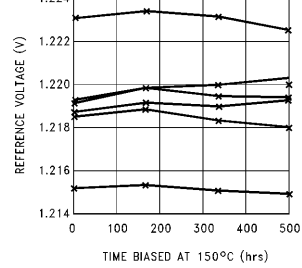

Reference Voltage vs Current and Temperature

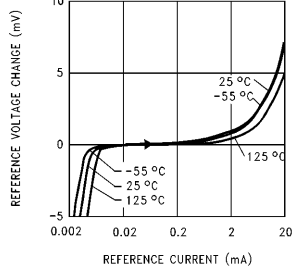

Reference Voltage vs Reference Current

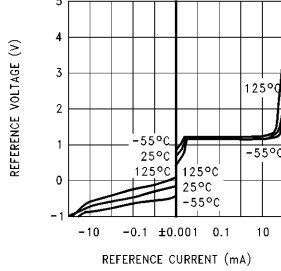

Reference Voltage Change with Supply Voltage Step

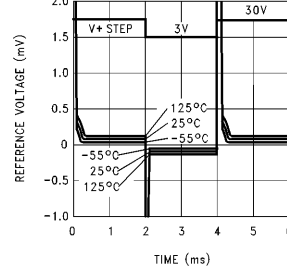

Reference AC Stability Range

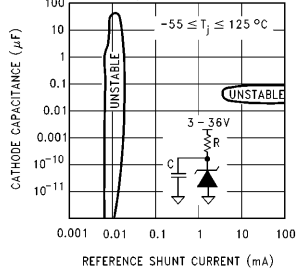

Reference Noise Voltage vs Frequency

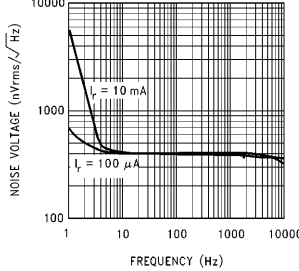

Reference Small-Signal Impedance vs Frequency

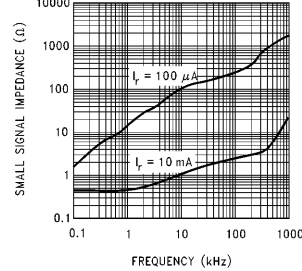

Reference Power-Up Time

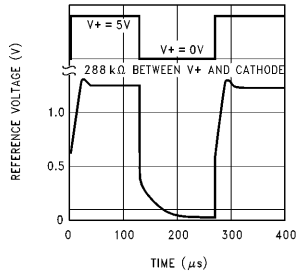

Reference Voltage with 100 ~ 12 µA Current Step

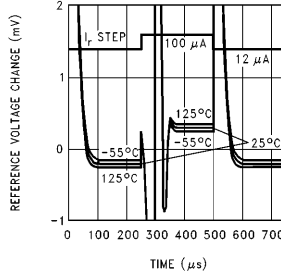

Reference Step Response for 100 µA ~ 10 mA Current Step

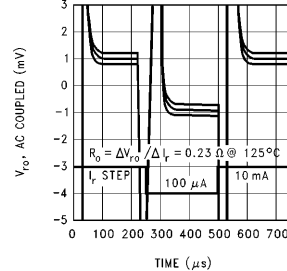

TL/H/11058-4

Typical Performance Characteristics (Comparators)

$T_J = 25^\circ\text{C}$, $V^+ = 5\text{V}$, $V^- = 0\text{V}$

Supply Current vs Supply Voltage

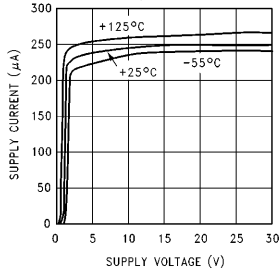

Input Bias Current vs Common-Mode Voltage

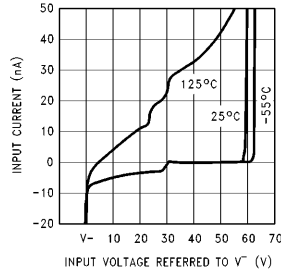

Input Current vs Differential Input Voltage

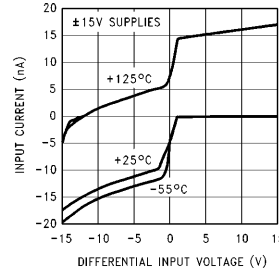

Output Saturation Voltage vs Sink Current

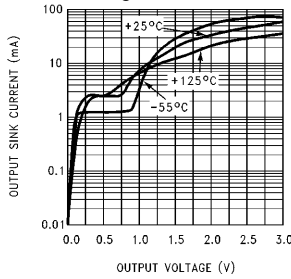

Small-Signal Response Times—Inverting Input, Negative Transition

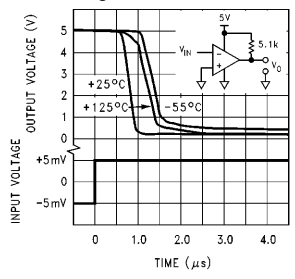

Small-Signal Response Times—Inverting Input, Positive Transition

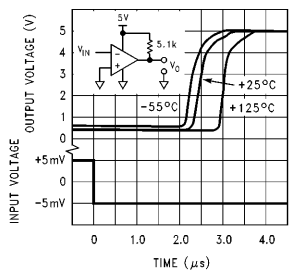

Small-Signal Response Times—Non-Inverting Input, Positive Transition

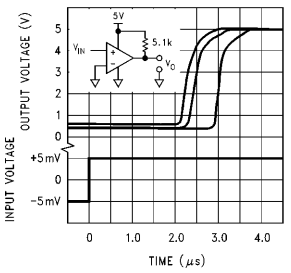

Small-Signal Response Times—Non-Inverting Input, Negative Transition

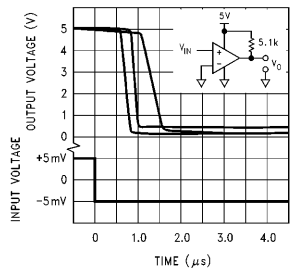

Large-Signal Response Times—Inverting Input, Positive Transition

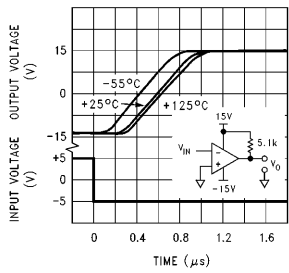

Large-Signal Response Times—Inverting Input, Negative Transition

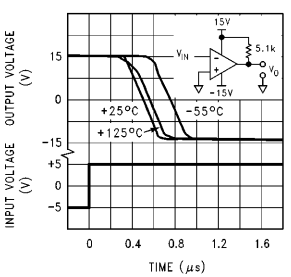

Large-Signal Response Times—Non-Inverting Input, Positive Transition

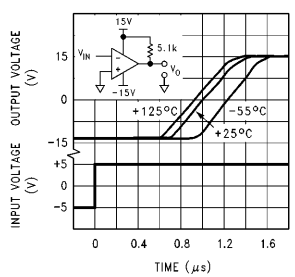

Large-Signal Response Times—Non-Inverting Input, Negative Transition

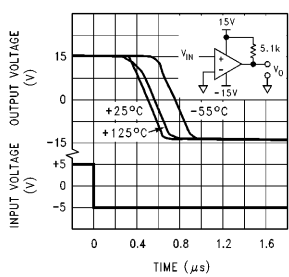

TL/H/11058-6

Application Information

VOLTAGE REFERENCE

Reference Biasing

The voltage reference is of a shunt regulator topology that models as a simple zener diode. With current I_R flowing in the “forward” direction there is the familiar diode transfer function. I_R flowing in the reverse direction forces the reference voltage to be developed from cathode to anode.

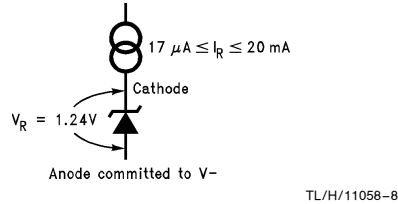

FIGURE 1. 1.24V Reference is Developed between Cathode and Anode; Current Source I_R is External

The reference equivalent circuit reveals how V_R is held at the constant 1.2V by feedback for a wide range of reverse current.

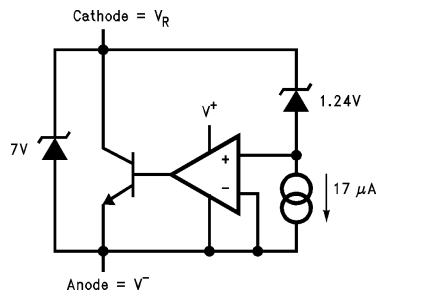

FIGURE 2. Reference Equivalent Circuit

To generate the required reverse current, typically a resistor is connected from a supply voltage higher than the reference voltage to the Reference Output pin. Varying that voltage, and so varying I_R , has small effect with the equivalent series resistance of less than an ohm at the higher currents. Alternatively, an active current source, such as the LM134 series, may generate I_R .

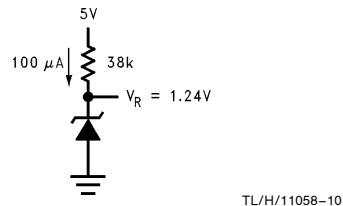

FIGURE 3. 1.2V Reference

Capacitors in parallel with the reference are allowed. See the Reference AC Stability Range typical curve for capacitance values—from $20 \mu\text{A}$ to 3 mA the reference is stable for any value of capacitance. With the reference’s wide stability range with resistive and capacitive loads, a wide range of RC filter values will perform noise filtering when necessary.

Reference Hysteresis

The reference voltage depends, slightly, on the thermal history of the die. Competitive micro-power products vary—always check the datasheet for any given device. Do not assume that no specification means no hysteresis.

COMPARATORS

Either comparator or the reference may be biased in any way with no effect on the other sections of the LM612, except when a substrate diode conducts (see Electrical Characteristics Note 3). For example, one or both inputs of one comparator may be outside the input voltage range limits, the reference may be unpowered, and the other comparator will still operate correctly. The inverting input of an unused comparator should be tied to V^- and the non-inverting tied to V^+ .

Hysteresis

Any comparator may oscillate or produce a noisy output if the applied differential input voltage is near the comparator’s offset voltage. This usually happens when the input signal is moving very slowly across the comparator’s switching threshold. This problem can be prevented by the addition of hysteresis, or positive feedback, as shown in *Figure 4*.

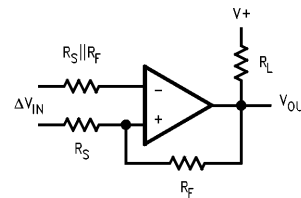

FIGURE 4. R_S and R_F Add Hysteresis to Comparator

The amount of hysteresis added in *Figure 4* is

$$V_H = V^+ \times \frac{R_S}{(R_F + R_S)}$$

$$\approx V^+ \times \frac{R_S}{R_F} \quad \text{for } R_F \gg R_S$$

A good rule of thumb is to add hysteresis of at least the maximum specified offset voltage. More than about 50 mV

Application Information (Continued)

of hysteresis can substantially reduce the accuracy of the comparator, since the offset voltage is effectively being increased by the hysteresis when the comparator output is high.

It is often a good idea to decrease the amount of hysteresis until oscillations are observed, then use three times that minimum hysteresis in the final circuit. Note that the amount of hysteresis needed is greatly affected by layout. The amount of hysteresis should be rechecked each time the layout is changed, such as changing from a breadboard to a P.C. board.

Input Stage

The input stage uses lateral PNP input transistors which, unlike those of many op amps, have breakdown voltage BV_{EBO} equal to the absolute maximum supply voltage. Also, they have no diode clamps to the positive supply nor across the inputs. These features make the inputs look like high impedances to input sources producing large differential and common-mode voltages.

The guaranteed common-mode input voltage range for an LM612 is $V^- \leq V_{CM} \leq (V^+ - 1.8V)$, over temperature. This is the voltage range in which the comparisons must be made. If both inputs are within this range, the output will be at the correct state. If one input is within this range, and the other input is less than $(V^- + 32V)$, even if this is greater than V^+ , the output will be at the correct state. If, however, either or both inputs are driven below V^- , and either input current exceeds $10 \mu A$, the output state is not guaranteed to be correct. If both inputs are above $(V^+ - 1.8V)$, the output state is also not guaranteed to be correct.

Output Stage

The comparators have a common open-collector output stage which requires a pull-up resistor to a positive supply voltage for the output to switch properly. When the internal output transistor is off, the output (HIGH) voltage will be pulled up to this external positive voltage.

To ensure that the LOW output voltage is under the TTL-low threshold, the output transistor's load current must be less than 0.8 mA (over temperature) when it turns on. This impacts the minimum value of the pull-up resistor.

Typical Applications

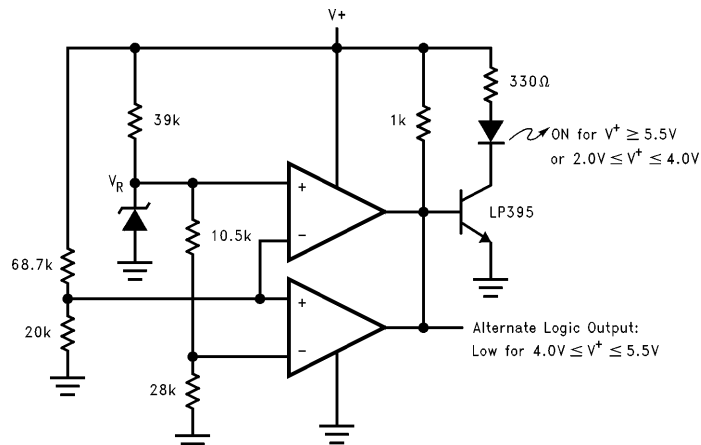

Power Supply Monitor with Indicator

TL/H/11058-12

Physical Dimensions inches (millimeters)

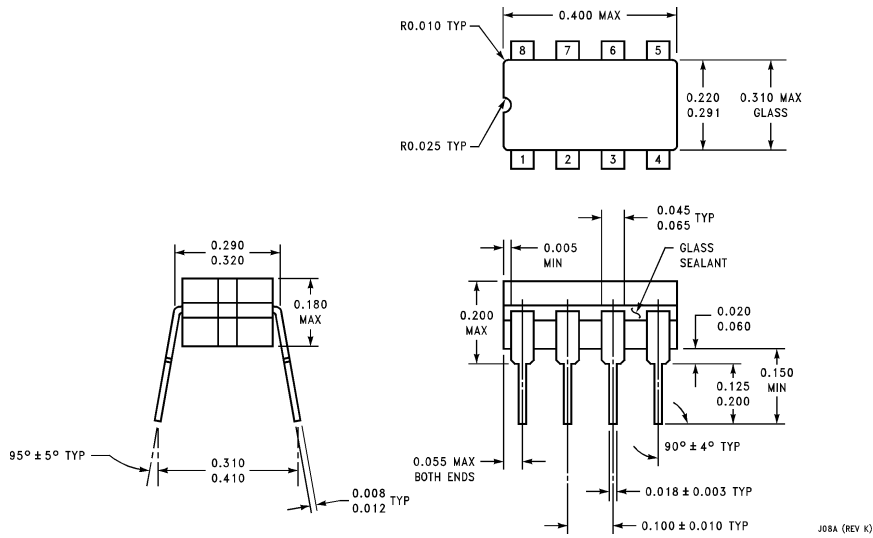

8-Pin Ceramic Dual-In-Line Package (J)
Order Number LM612AMJ/883
NS Package Number J08A

J08A (REV K)

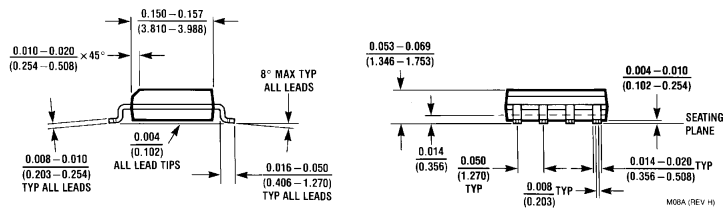
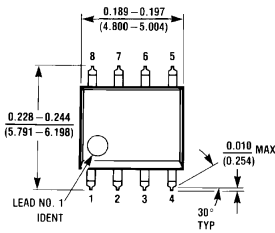

8-Pin Surface Mount Package (M)
Order Number LM612IM
NS Package Number M08A

M08A (REV H)

Physical Dimensions inches (millimeters) (Continued)

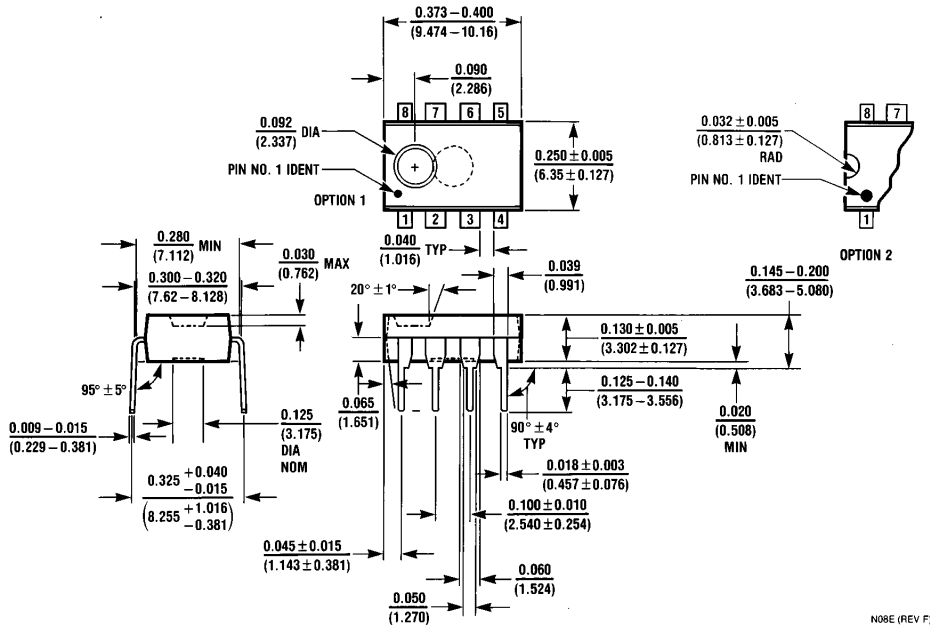

8-Pin Molded Dual-In-Line Package (N)
 Order Number LM612AMJ/883, LM612AMN, LM612AIN, LM612MN or LM612IN
 NS Package Number N08E

N08E (REV F)

LIFE SUPPORT POLICY

NATIONAL'S PRODUCTS ARE NOT AUTHORIZED FOR USE AS CRITICAL COMPONENTS IN LIFE SUPPORT DEVICES OR SYSTEMS WITHOUT THE EXPRESS WRITTEN APPROVAL OF THE PRESIDENT OF NATIONAL SEMICONDUCTOR CORPORATION. As used herein:

1. Life support devices or systems are devices or systems which, (a) are intended for surgical implant into the body, or (b) support or sustain life, and whose failure to perform, when properly used in accordance with instructions for use provided in the labeling, can be reasonably expected to result in a significant injury to the user.
2. A critical component is any component of a life support device or system whose failure to perform can be reasonably expected to cause the failure of the life support device or system, or to affect its safety or effectiveness.



National Semiconductor Corporation
 1111 West Bardin Road
 Arlington, TX 76017
 Tel: 1(800) 272-9959
 Fax: 1(800) 737-7018

National Semiconductor Europe
 Fax: (+49) 0-180-530 85 86
 Email: cnjwge@tevm2.nsc.com
 Deutsch Tel: (+49) 0-180-530 85 85
 English Tel: (+49) 0-180-532 78 32
 Français Tel: (+49) 0-180-532 93 58
 Italiano Tel: (+49) 0-180-534 16 80

National Semiconductor Hong Kong Ltd.
 19th Floor, Straight Block,
 Ocean Centre, 5 Canton Rd.
 Tsimshatsui, Kowloon
 Hong Kong
 Tel: (852) 2737-1600
 Fax: (852) 2736-9960

National Semiconductor Japan Ltd.
 Tel: 81-043-299-2309
 Fax: 81-043-299-2408

National does not assume any responsibility for use of any circuitry described, no circuit patent licenses are implied and National reserves the right at any time without notice to change said circuitry and specifications.