

LM61

2.7V, SOT-23 or TO-92 Temperature Sensor

General Description

The LM61 is a precision integrated-circuit temperature sensor that can sense a -30°C to $+100^{\circ}\text{C}$ temperature range while operating from a single $+2.7\text{V}$ supply. The LM61's output voltage is linearly proportional to Celsius (Centigrade) temperature ($+10\text{ mV}/^{\circ}\text{C}$) and has a DC offset of $+600\text{ mV}$. The offset allows reading negative temperatures without the need for a negative supply. The nominal output voltage of the LM61 ranges from $+300\text{ mV}$ to $+1600\text{ mV}$ for a -30°C to $+100^{\circ}\text{C}$ temperature range. The LM61 is calibrated to provide accuracies of $\pm 2.0^{\circ}\text{C}$ at room temperature and $\pm 3^{\circ}\text{C}$ over the full -25°C to $+85^{\circ}\text{C}$ temperature range.

The LM61's linear output, $+600\text{ mV}$ offset, and factory calibration simplify external circuitry required in a single supply environment where reading negative temperatures is required. Because the LM61's quiescent current is less than $125\text{ }\mu\text{A}$, self-heating is limited to a very low 0.2°C in still air. Shutdown capability for the LM61 is intrinsic because its inherent low power consumption allows it to be powered directly from the output of many logic gates.

Features

- Calibrated linear scale factor of $+10\text{ mV}/^{\circ}\text{C}$
- Rated for full -30° to $+100^{\circ}\text{C}$ range
- Suitable for remote applications

Applications

- Cellular Phones
- Computers
- Power Supply Modules
- Battery Management
- FAX Machines
- Printers
- HVAC
- Disk Drives
- Appliances

Key Specifications

- | | |
|--|---|
| ■ Accuracy at 25°C | ± 2.0 or $\pm 3.0^{\circ}\text{C}$
(max) |
| ■ Accuracy for -30°C to $+100^{\circ}\text{C}$ | $\pm 4.0^{\circ}\text{C}$ (max) |
| ■ Accuracy for -25°C to $+85^{\circ}\text{C}$ | $\pm 3.0^{\circ}\text{C}$ (max) |
| ■ Temperature Slope | $+10\text{ mV}/^{\circ}\text{C}$ |
| ■ Power Supply Voltage Range | $+2.7\text{V}$ to $+10\text{V}$ |
| ■ Current Drain @ 25°C | $125\text{ }\mu\text{A}$ (max) |
| ■ Nonlinearity | $\pm 0.8^{\circ}\text{C}$ (max) |
| ■ Output Impedance | $800\text{ }\Omega$ (max) |

Typical Application

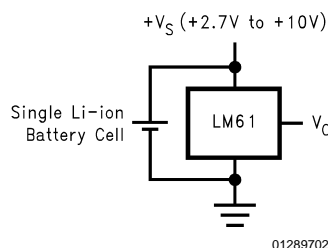

$$V_O = (+10\text{ mV}/^{\circ}\text{C} \times T\text{ }^{\circ}\text{C}) + 600\text{ mV}$$

Temperature (T)	Typical V_O
$+100^{\circ}\text{C}$	$+1600\text{ mV}$
$+85^{\circ}\text{C}$	$+1450\text{ mV}$
$+25^{\circ}\text{C}$	$+850\text{ mV}$
0°C	$+600\text{ mV}$
-25°C	$+350\text{ mV}$
-30°C	$+300\text{ mV}$

FIGURE 1. Full-Range Centigrade Temperature Sensor (-30°C to $+100^{\circ}\text{C}$) Operating from a Single Li-Ion Battery Cell

Connection Diagrams

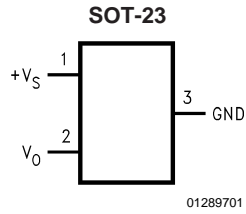

Top View
See NS Package Number MA03B

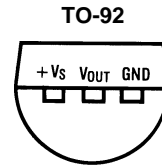

BOTTOM VIEW
See NS Package Number Z03A

Ordering Information

Order Number	Device Marking	Supplied In	Accuracy Over Specified Temperature Range (°C)	Specified Temperature Range	Package Type
LM61BIM3	T1B	1000 Units on Tape and Reel	± 3	-25°C to +85°C	SOT-23
LM61BIM3X	T1B	3000 Units on Tape and Reel			
LM61CIM3	T1C	1000 Units on Tape and Reel	± 4	-30°C to +100°C	
LM61CIM3X	T1C	3000 Units on Tape and Reel			
LM61BIZ	LM61BIZ	Bulk	± 3	-25°C to +85°C	TO-92
LM61CIZ	LM61CIZ	Bulk	± 4	-30°C to +100°C	

Absolute Maximum Ratings (Note 1)

Supply Voltage	+12V to -0.2V
Output Voltage	(+V _S + 0.6V) to -0.6V
Output Current	10 mA
Input Current at any pin (Note 2)	5 mA
Storage Temperature	-65°C to +150°C
Maximum Junction Temperature (T _{JMAX})	+125°C
ESD Susceptibility (Note 3) :	
Human Body Model	2500V
Machine Model	250V
Lead Temperature:	
TO-92 Package:	

Soldering (10 seconds)	+260°C
SOT-23 Package (Note 4):	
Vapor Phase (60 seconds)	+215°C
Infrared (15 seconds)	+220°C

Operating Ratings(Note 1)

Specified Temperature Range:	T_{MIN} ≤ T_A ≤ T_{MAX}
LM61C	-30°C ≤ T _A ≤ +100°C
LM61B	-25°C ≤ T _A ≤ +85°C
Supply Voltage Range (+V _S)	+2.7V to +10V
Thermal Resistance, θ _{JA} (Note 5)	
SOT-23	450°C/W
TO-92	180°C/W

Electrical Characteristics

Unless otherwise noted, these specifications apply for +V_S = +3.0 V_{DC}. **Boldface limits apply for T_A = T_J = T_{MIN} to T_{MAX}** ; all other limits T_A = T_J = 25°C.

Parameter	Conditions	Typical (Note 6)	LM61B	LM61C	Units (Limit)
			Limits (Note 7)	Limits (Note 7)	
Accuracy (Note 8)			±2.0	±3.0	°C (max)
			±3.0	±4.0	°C (max)
Output Voltage at 0°C		+600			mV
Nonlinearity (Note 9)			±0.6	±0.8	°C (max)
Sensor Gain (Average Slope)		+10	+9.7	+9.6	mV/°C (min)
			+10.3	+10.4	mV/°C (max)
Output Impedance	+3.0V ≤ +V _S ≤ +10V -30°C ≤ T _A ≤ +85°C, +V _S = +2.7V +85°C ≤ T _A ≤ +100°C, +V _S = +2.7V		0.8	0.8	kΩ (max)
			2.3	2.3	kΩ (max)
			5	5	kΩ (max)
Line Regulation (Note 10)	+3.0V ≤ +V _S ≤ +10V		±0.7	±0.7	mV/V (max)
	+2.7V ≤ +V _S ≤ +3.3V		±5.7	±5.7	mV (max)
Quiescent Current	+2.7V ≤ +V _S ≤ +10V	82	125	125	μA (max)
			155	155	μA (max)
Change of Quiescent Current	+2.7V ≤ +V _S ≤ +10V	±5			μA
Temperature Coefficient of Quiescent Current		0.2			μA/°C
Long Term Stability (Note 11)	T _J = T _{MAX} = +100°C, for 1000 hours	±0.2			°C

Note 1: Absolute Maximum Ratings indicate limits beyond which damage to the device may occur. Operating Ratings indicate conditions for which the device is functional, but do not guarantee specific performance limits. For guaranteed specifications and test conditions, see the Electrical Characteristics. The guaranteed specifications apply only for the test conditions listed. Some performance characteristics may degrade when the device is not operated under the listed test conditions.

Note 2: When the input voltage (V_I) at any pin exceeds power supplies (V_I < GND or V_I > +V_S), the current at that pin should be limited to 5 mA.

Note 3: The human body model is a 100 pF capacitor discharged through a 1.5 kΩ resistor into each pin. The machine model is a 200 pF capacitor discharged directly into each pin.

Note 4: See AN-450 "Surface Mounting Methods and Their Effect on Product Reliability" or the section titled "Surface Mount" found in any post 1986 National Semiconductor Linear Data Book for other methods of soldering surface mount devices.

Note 5: The junction to ambient thermal resistance (θ_{JA}) is specified without a heat sink in still air.

Note 6: Typicals are at T_J = T_A = 25°C and represent most likely parametric norm.

Note 7: Limits are guaranteed to National's AOQL (Average Outgoing Quality Level).

Note 8: Accuracy is defined as the error between the output voltage and +10 mV/°C times the device's case temperature plus 600 mV, at specified conditions of voltage, current, and temperature (expressed in °C).

Note 9: Nonlinearity is defined as the deviation of the output-voltage-versus-temperature curve from the best-fit straight line, over the device's rated temperature range.

Electrical Characteristics (Continued)

Note 10: Regulation is measured at constant junction temperature, using pulse testing with a low duty cycle. Changes in output due to heating effects can be computed by multiplying the internal dissipation by the thermal resistance.

Note 11: For best long-term stability, any precision circuit will give best results if the unit is aged at a warm temperature, and/or temperature cycled for at least 46 hours before long-term life test begins. This is especially true when a small (Surface-Mount) part is wave-soldered; allow time for stress relaxation to occur. The majority of the drift will occur in the first 1000 hours at elevated temperatures. The drift after 1000 hours will not continue at the first 1000 hour rate.

Typical Performance Characteristics The LM61 in the SOT-23 package mounted to a printed circuit board as shown in *Figure 2* was used to generate the following thermal curves.

**Thermal Resistance
Junction to Air**

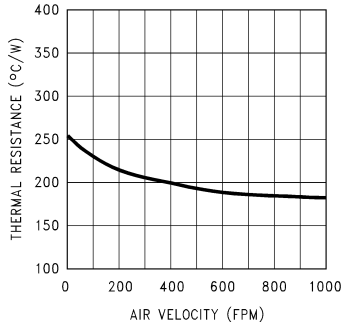

01289703

Thermal Time Constant

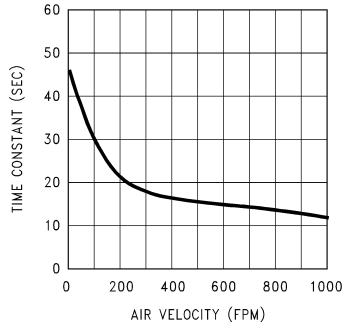

01289704

**Thermal Response in
Still Air with Heat Sink**

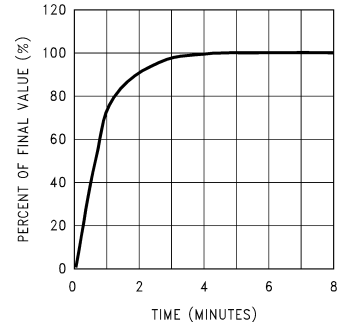

01289705

**Thermal Response
in Stirred Oil Bath
with Heat Sink**

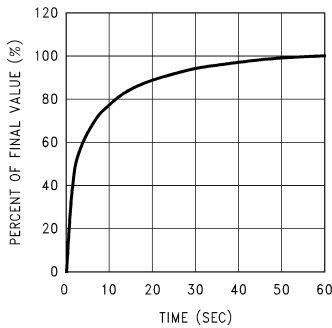

01289706

**Thermal Response in Still
Air without a Heat Sink**

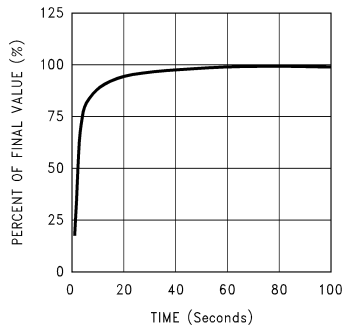

01289708

**Quiescent Current
vs. Temperature**

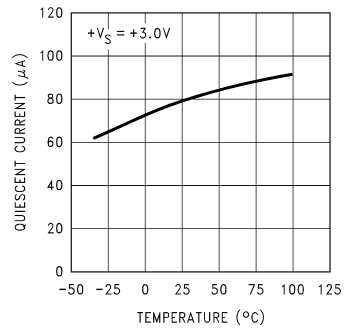

01289709

Accuracy vs Temperature

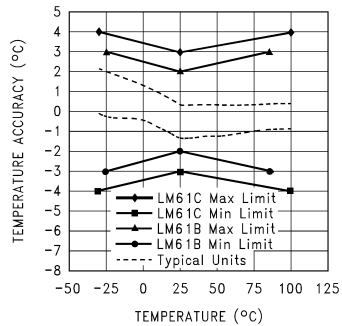

01289710

Noise Voltage

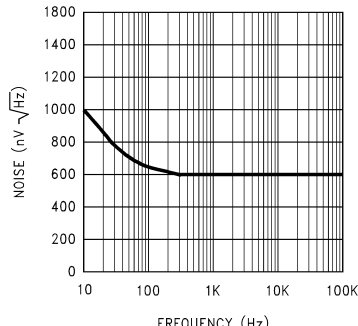

01289711

**Supply Voltage
vs Supply Current**

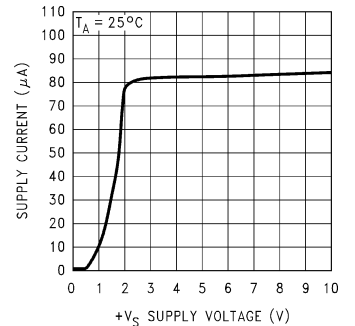

01289712

Typical Performance Characteristics The LM61 in the SOT-23 package mounted to a printed circuit board as shown in *Figure 2* was used to generate the following thermal curves. (Continued)

Start-Up Response

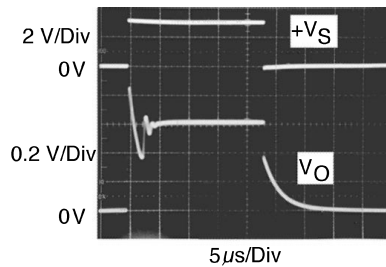

01289722

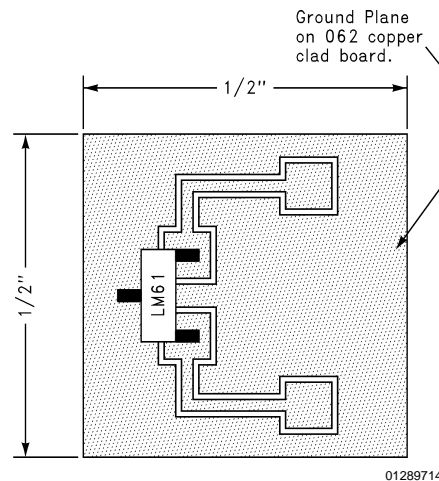

01289714

FIGURE 2. Printed Circuit Board Used for Heat Sink to Generate All Curves.
1/2" Square Printed Circuit Board with 2 oz. Copper Foil or Similar.

1.0 Mounting

The LM61 can be applied easily in the same way as other integrated-circuit temperature sensors. It can be glued or cemented to a surface. The temperature that the LM61 is sensing will be within about $+0.2^{\circ}\text{C}$ of the surface temperature that LM61's leads are attached to.

This presumes that the ambient air temperature is almost the same as the surface temperature; if the air temperature were much higher or lower than the surface temperature, the actual temperature measured would be at an intermediate temperature between the surface temperature and the air temperature.

To ensure good thermal conductivity the backside of the LM61 die is directly attached to the GND pin. The lands and traces to the LM61 will, of course, be part of the printed circuit board, which is the object whose temperature is being measured.

Alternatively, the LM61 can be mounted inside a sealed-end metal tube, and can then be dipped into a bath or screwed into a threaded hole in a tank. As with any IC, the LM61 and

accompanying wiring and circuits must be kept insulated and dry, to avoid leakage and corrosion. This is especially true if the circuit may operate at cold temperatures where condensation can occur. Printed-circuit coatings and varnishes such as Humiseal and epoxy paints or dips are often used to ensure that moisture cannot corrode the LM61 or its connections.

The thermal resistance junction to ambient (θ_{JA}) is the parameter used to calculate the rise of a device junction temperature due to its power dissipation. For the LM61 the equation used to calculate the rise in the die temperature is as follows:

$$T_J = T_A + \theta_{JA} [(+V_S I_Q) + (+V_S - V_O) I_L]$$

where I_Q is the quiescent current and I_L is the load current on the output. Since the LM61's junction temperature is the actual temperature being measured care should be taken to minimize the load current that the LM61 is required to drive.

The table shown in *Figure 3* summarizes the rise in die temperature of the LM61 without any loading with a 3.3V supply, and the thermal resistance for different conditions.

1.0 Mounting (Continued)

	SOT-23*		SOT-23**		TO-92*		TO-92***	
	no heat sink		small heat fin		no heat sink		small heat fin	
	θ_{JA} (°C/W)	$T_J - T_A$ (°C)	θ_{JA} (°C/W)	$T_J - T_A$ (°C)	θ_{JA} (°C/W)	$T_J - T_A$ (°C)	θ_{JA} (°C/W)	$T_J - T_A$ (°C)
Still air	450	0.26	260	0.13	180	0.09	140	0.07
Moving air			180	0.09	90	0.05	70	0.03

*Part soldered to 30 gauge wire.

**Heat sink used is 1/2" square printed circuit board with 2 oz. foil with part attached as shown in *Figure 2*.

***Part glued and leads soldered to 1" square of 1/16" printed circuit board with 2oz. foil or similar.

FIGURE 3. Temperature Rise of LM61 Due to Self-Heating and Thermal Resistance (θ_{JA})

2.0 Capacitive Loads

The LM61 handles capacitive loading well. Without any special precautions, the LM61 can drive any capacitive load as shown in *Figure 4*. Over the specified temperature range the LM61 has a maximum output impedance of 5 k Ω . In an extremely noisy environment it may be necessary to add some filtering to minimize noise pickup. It is recommended that 0.1 μ F be added from +V_S to GND to bypass the power supply voltage, as shown in *Figure 5*. In a noisy environment it may be necessary to add a capacitor from the output to ground. A 1 μ F output capacitor with the 5 k Ω maximum output impedance will form a 32 Hz lowpass filter. Since the thermal time constant of the LM61 is much slower than the 5 ms time constant formed by the RC, the overall response time of the LM61 will not be significantly affected. For much larger capacitors this additional time lag will increase the overall response time of the LM61.

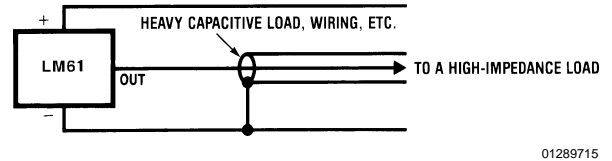

01289715

FIGURE 4. LM61 No Decoupling Required for Capacitive Load

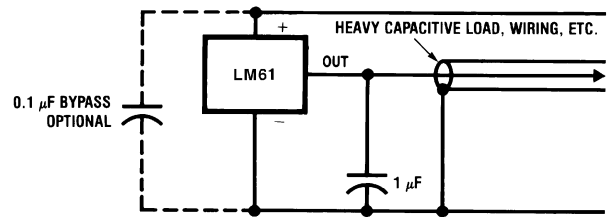

01289716

FIGURE 5. LM61 with Filter for Noisy Environment

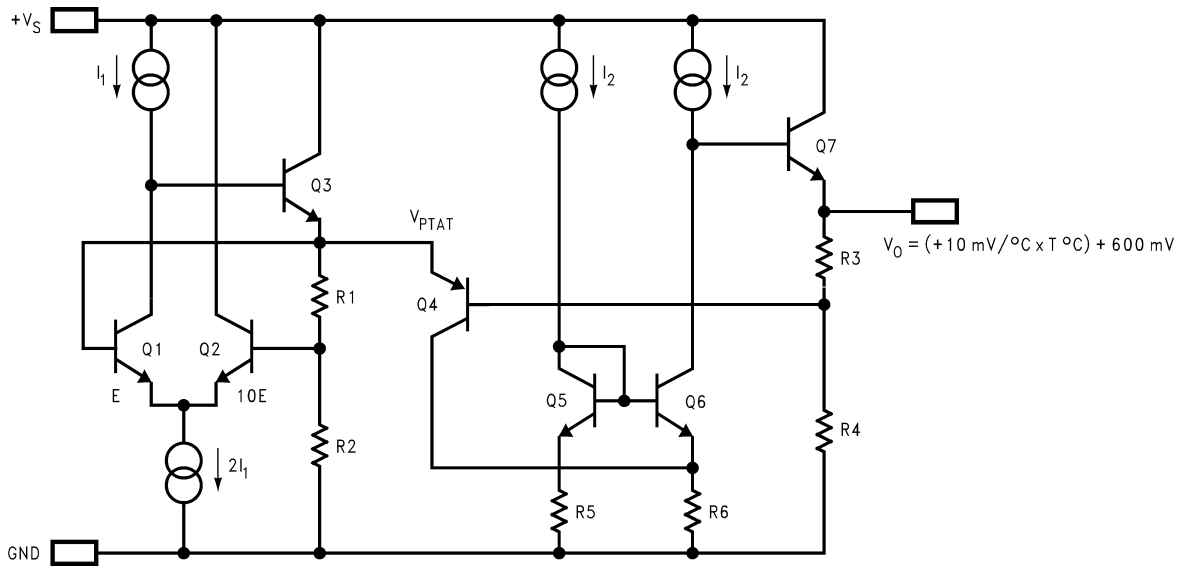

01289717

FIGURE 6. Simplified Schematic

3.0 Applications Circuits

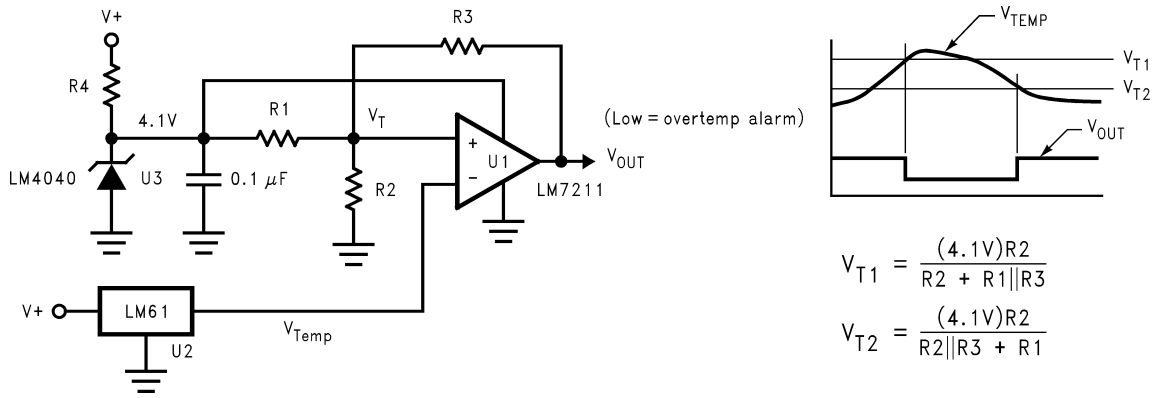

$$V_{T1} = \frac{(4.1V) R2}{R2 + R1 \parallel R3}$$

$$V_{T2} = \frac{(4.1V) R2}{R2 \parallel R3 + R1}$$

01289718

FIGURE 7. Centigrade Thermostat

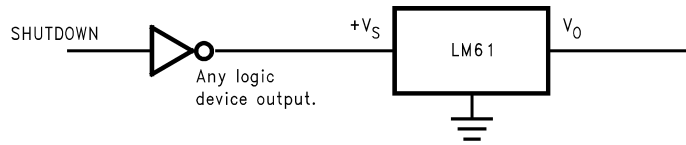

01289719

FIGURE 8. Conserving Power Dissipation with Shutdown

4.0 Recommended Solder Pads for SOT-23 Package

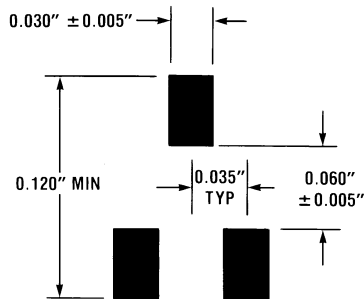

01289720

Physical Dimensions inches (millimeters)

unless otherwise noted

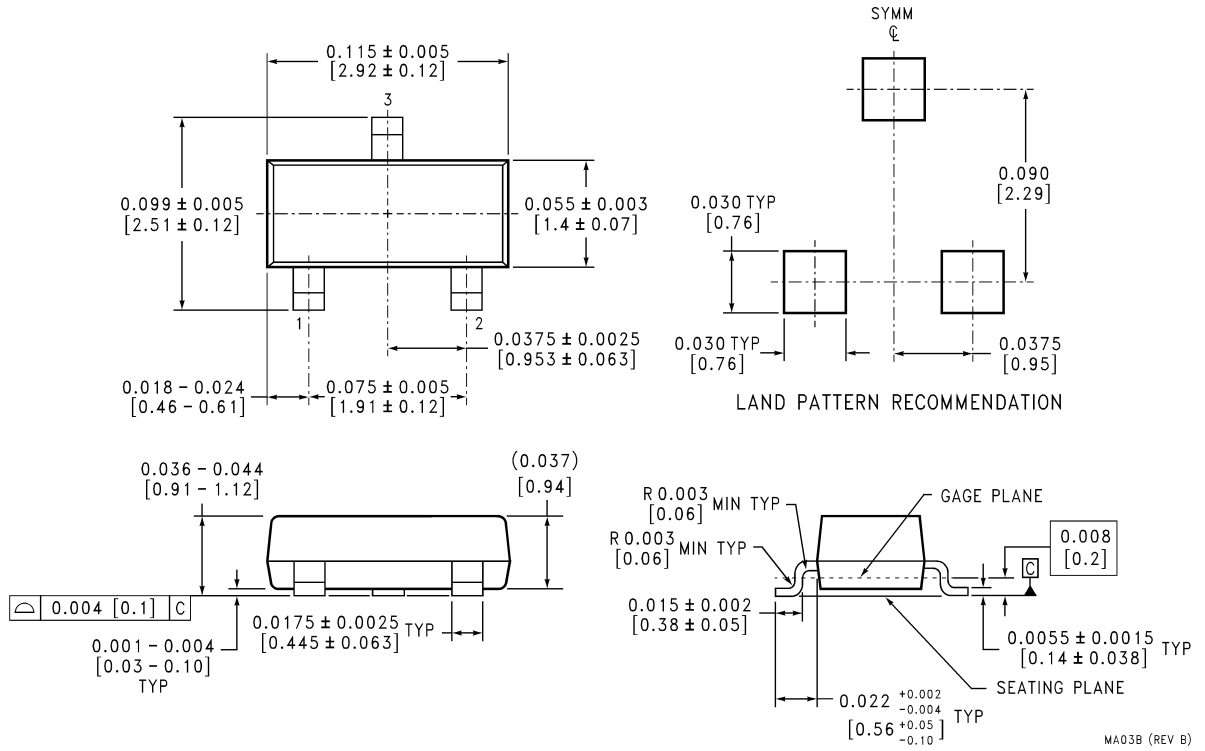

SOT-23 Molded Small Outline Transistor Package (M3)
Order Number LM61BIM3, LM61BIM3X, LM61CIM3 or LM61CIM3X
NS Package Number MA03B

MA03B (REV B)

Physical Dimensions inches (millimeters) unless otherwise noted (Continued)

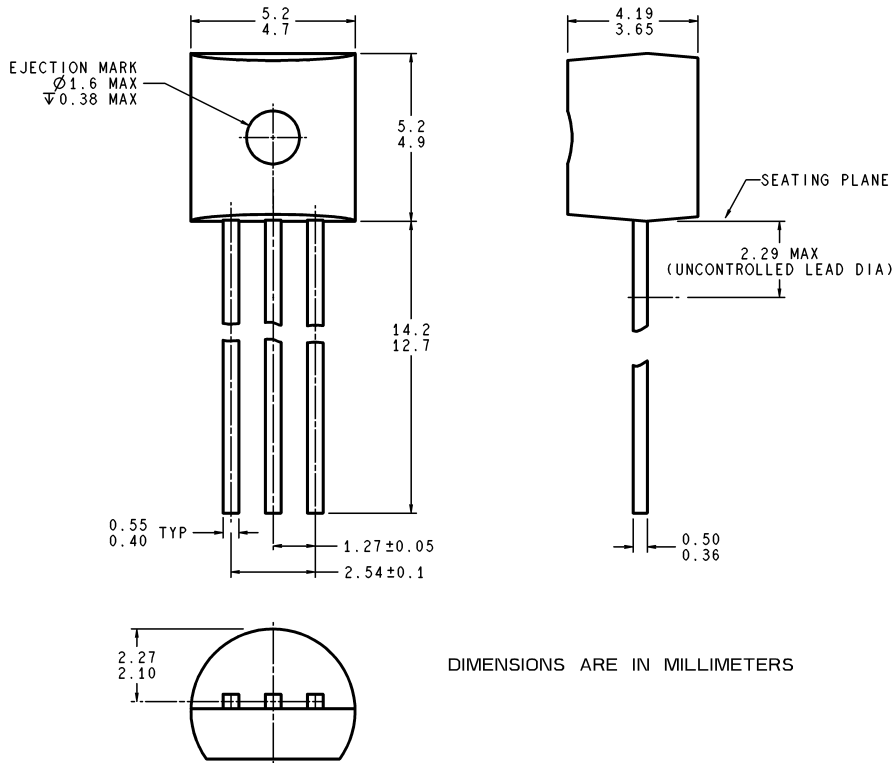

Z03A (Rev G)

TO-92 Plastic Package (Z)
Order Number LM61BIZ or LM61CIZ
NS Package Number Z03A

LIFE SUPPORT POLICY

NATIONAL'S PRODUCTS ARE NOT AUTHORIZED FOR USE AS CRITICAL COMPONENTS IN LIFE SUPPORT DEVICES OR SYSTEMS WITHOUT THE EXPRESS WRITTEN APPROVAL OF THE PRESIDENT AND GENERAL COUNSEL OF NATIONAL SEMICONDUCTOR CORPORATION. As used herein:

1. Life support devices or systems are devices or systems which, (a) are intended for surgical implant into the body, or (b) support or sustain life, and whose failure to perform when properly used in accordance with instructions for use provided in the labeling, can be reasonably expected to result in a significant injury to the user.
2. A critical component is any component of a life support device or system whose failure to perform can be reasonably expected to cause the failure of the life support device or system, or to affect its safety or effectiveness.

 **National Semiconductor Corporation**
Americas
Tel: 1-800-272-9959
Fax: 1-800-737-7018
Email: support@nsc.com
www.national.com

National Semiconductor Europe
Fax: +49 (0) 180-530 85 86
Email: europe.support@nsc.com
Deutsch Tel: +49 (0) 69 9508 6208
English Tel: +44 (0) 870 24 0 2171
Français Tel: +33 (0) 1 41 91 8790

National Semiconductor Asia Pacific Customer Response Group
Tel: 65-2544466
Fax: 65-2504466
Email: ap.support@nsc.com

National Semiconductor Japan Ltd.
Tel: 81-3-5639-7560
Fax: 81-3-5639-7507