

LMH6502

Wideband, Low Power, Linear-in-dB Variable Gain Amplifier

General Description

The LMH™6502 is a wideband DC coupled differential input voltage controlled gain stage followed by a high-speed current feedback Op Amp which can directly drive a low impedance load. Gain adjustment range is more than 70dB for up to 10MHz.

Maximum gain is set by external components and the gain can be reduced all the way to cut-off. Power consumption is 300mW with a speed of 130MHz. Output referred DC offset voltage is less than 350mV over the entire gain control voltage range. Device-to-device Gain matching is within ±0.6dB at maximum gain. Furthermore, gain at any V_G is tested and the tolerance is guaranteed. The output current feedback Op Amp allows high frequency large signals (Slew Rate = 1800V/μs) and can also drive heavy load current (75mA). Differential inputs allow common mode rejection in low level amplification or in applications where signals are carried over relatively long wires. For single ended operation, the unused input can easily be tied to ground (or to a virtual half-supply in single supply application). Inverting or non-inverting gains could be obtained by choosing one input polarity or the other.

To provide ease of use when working with a single supply, V_G range is set to be from 0V to +2V relative to pin 11 potential (ground pin). In single supply operation, this ground pin is tied to a "virtual" half supply.

LMH6502 gain control is linear in dB for a large portion of the total gain control range. This makes the device suitable for AGC circuits among other applications. For linear gain control applications, see the LMH6503 datasheet. The LMH6502 is available in the SOIC-14 and TSSOP-14 package.

Features

$V_S = \pm 5V$, $T_A = 25^\circ C$, $R_F = 1k\Omega$, $R_G = 174\Omega$, $R_L = 100\Omega$, $A_V = A_{V(MAX)} = 10$ Typical values unless specified.

- -3dB BW 130MHz
- Gain control BW 100MHz
- Adjustment range (typical over temp) 70dB
- Gain matching (limit) ±0.6dB
- Slew rate 1800V/μs
- Supply current (no load) 27mA
- Linear output current ±75mA
- Output voltage ($R_L = 100\Omega$) ±3.2V
- Input voltage noise $7.7nV/\sqrt{Hz}$
- Input current noise $2.4pA/\sqrt{Hz}$
- THD (20MHz, $R_L = 100\Omega$, $V_O = 2V_{PP}$) -53dBc
- Replacement for CLC520

Applications

- Variable attenuator
- AGC
- Voltage controller filter
- Video imaging processing

Gain vs. V_G for Various Temperature

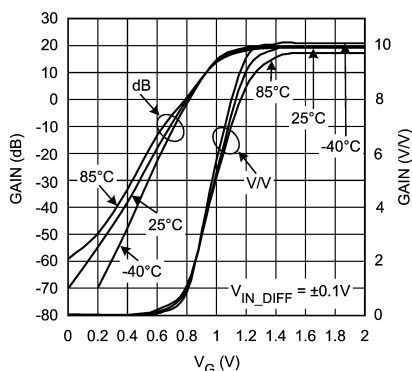

20067706

Typical Application

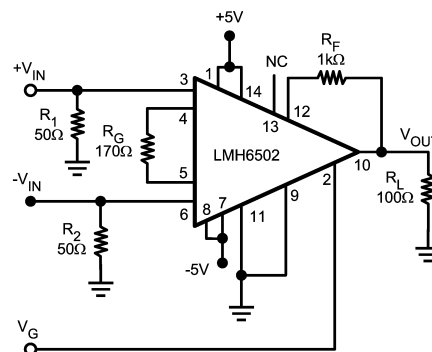

20067737

$A_{VMAX} = 10V/V$

LMH™ is a trademark of National Semiconductor Corporation.

LMH6502 Wideband, Low Power, Linear-in-dB Variable Gain Amplifier

Absolute Maximum Ratings (Note 1)

If Military/Aerospace specified devices are required, please contact the National Semiconductor Sales Office/Distributors for availability and specifications.

ESD Tolerance (Note 4):

Human Body	2KV
Machine Model	200V
Input Current	±10mA
V _{IN} Differential	±(V ⁺ - V ⁻)
Output Current	120mA (Note 3)
Supply Voltages (V ⁺ - V ⁻)	12.6V
Voltage at Input/ Output pins	V ⁺ +0.8V, V ⁻ - 0.8V
Storage Temperature Range	-65°C to +150°C

Junction Temperature	+150°C
Soldering Information:	
Infrared or Convection (20 sec)	235°C
Wave Soldering (10 sec)	260°C

Operating Ratings (Note 1)

Supply Voltages (V ⁺ - V ⁻)	5V to 12V
Temperature Range	-40°C to +85°C
Thermal Resistance:	(θ_{JC}) (θ_{JA})
14-Pin SOIC	45°C/W 138°C/W
14-Pin TSSOP	51°C/W 160°C/W

Electrical Characteristics(Note 2)

Unless otherwise specified, all limits guaranteed for T_J = 25°C, V_S = ±5V, A_{V(MAX)} = 10, V_{CM} = 0V, R_F = 1kΩ, R_G = 174Ω, V_{IN_DIFF} = ±0.1V, R_L = 100Ω, V_G = +2V. **Boldface** limits apply at the temperature extremes.

Symbol	Parameter	Conditions	Min (Note 6)	Typ (Note 6)	Max (Note 6)	Units
Frequency Domain Response						
BW	-3dB Bandwidth	V _{OUT} < 0.5 _{PP}		130		MHz
		V _{OUT} < 0.5 _{PP} , A _{V(MAX)} = 100		50		
GF	Gain Flatness	V _{OUT} < 0.5V _{PP} 0.6V ≤ V _G ≤ 2V, ±0.3dB		30		MHz
Att Range	Flat Band (Relative to Max Gain) Attenuation Range (Note 14)	±0.2dB, f < 30MHz		16		dB
		±0.1dB, f < 30MHz		7.5		
BW Control	Gain control Bandwidth	V _G = 1V (Note 13)		100		MHz
PL	Linear Phase Deviation	DC to 60MHz		1.5		deg
G Delay	Group Delay	DC to 130MHz		2.5		ns
CT (dB)	Feed-through	V _G = 0V, 30MHz (Output Referred)		-47		dB
GR	Gain Adjustment Range	f < 10MHz		72		dB
		f < 30MHz		67		
Time Domain Response						
t _r , t _f	Rise and Fall Time	0.5V Step		2.2		ns
OS %	Overshoot	0.5V Step		10		%
SR	Slew Rate	4V Step		1800		V/μs
Δ G Rate	Gain Change Rate	V _{IN} = 0.3V, 10%-90% of Final Output		4.8		dB/ns
Distortion & Noise Performance						
HD2	2 nd Harmonic Distortion	2V _{PP} , 20MHz		-55		dBc
HD3	3 rd Harmonic Distortion	2V _{PP} , 20MHz		-57		dBc
THD	Total Harmonic Distortion	2V _{PP} , 20MHz		-53		dBc
En tot	Total Equivalent Input Noise	1MHz to 150MHz		7.7		nV/√Hz
I _N	Input Noise Current	1MHz to 150MHz		2.4		pA/√Hz
DG	Differential Gain	f = 4.43MHz, R _L = 150Ω, Neg. Sync		0.34		%
DP	Differential Phase	f = 4.43MHz, R _L = 150Ω, Neg. Sync		0.10		deg

Electrical Characteristics(Note 2) (Continued)

Unless otherwise specified, all limits guaranteed for $T_J = 25^\circ\text{C}$, $V_S = \pm 5\text{V}$, $A_{V(\text{MAX})} = 10$, $V_{\text{CM}} = 0\text{V}$, $R_F = 1\text{k}\Omega$, $R_G = 174\Omega$, $V_{\text{IN_DIFF}} = \pm 0.1\text{V}$, $R_L = 100\Omega$, $V_G = +2\text{V}$. **Boldface** limits apply at the temperature extremes.

Symbol	Parameter	Conditions	Min (Note 6)	Typ (Note 6)	Max (Note 6)	Units
DC & Miscellaneous Performance						
GACCU	Gain Accuracy (See Application Note)	$V_G = 2.0\text{V}$		0.0	+0.6	dB
		$1\text{V} < V_G < 2\text{V}$		+0.6/-0.3	+3.1/-3.6	
G Match	Gain Matching (See Application Note)	$V_G = 2.0\text{V}$		-	± 0.6	dB
		$1 < V_G < 2\text{V}$		-	+2.8/-3.9	
K	Gain Multiplier (See Application Notes)		1.61 1.58	1.72	1.84 1.91	V/V
V_{CM}	Input Voltage Range	Pin 3 & 6 Common Mode, ICMRR1 > 55dB (Note 9)	± 2.0 ± 1.70	± 2.2		V
$V_{\text{IN_DIFF}}$	Differential Input Voltage	Between pins 3 & 6	± 0.3 ± 0.12	± 0.39		V
$I_{\text{RG_MAX}}$	R_G Current	Pins 4 & 5	± 1.70 ± 1.56	± 2.22		mA
I_{BIAS}	Bias Current	Pins 3 & 6 (Note 7)		9	18 20	μA
		Pins 3 & 6 (Note 7), $V_S = \pm 2.5\text{V}$		2.5	5 6	
TC I_{BIAS}	Bias Current Drift	Pin 3 & 6 (Note 8)		100		$\text{nA}/^\circ\text{C}$
I_{OFF}	Offset Current	Pin 3 & 6		0.01	2.0 3.6	μA
TC I_{OFF}	Offset Current Drift	(Note 8)		5		$\text{nA}/^\circ\text{C}$
R_{IN}	Input Resistance	Pin 3 & 6		750		$\text{k}\Omega$
C_{IN}	Input Capacitance	Pin 3 & 6		5		pF
I_{VG}	V_G Bias Current	Pin 2, $V_G = 0\text{V}$ (Note 7)		-300		μA
TC I_{VG}	V_G Bias Drift	Pin 2 (Note 8)		20		$\text{nA}/^\circ\text{C}$
R_{VG}	V_G Input Resistance	Pin 2		10		$\text{k}\Omega$
C_{VG}	V_G Input Capacitance	Pin 2		1.3		pF
V_{OUT}	Output Voltage Range	$R_L = 100\Omega$	± 3.00 ± 2.95	± 3.20		V
		$R_L = \text{Open}$	± 3.95 ± 3.82	± 4.00		
R_{OUT}	Output Impedance	DC		0.1		Ω
I_{OUT}	Output Current	$V_{\text{OUT}} = \pm 4\text{V}$ from Rails	± 80 ± 75	± 90		mA
$V_{\text{O OFFSET}}$	Output Offset Voltage	$0\text{V} < V_G < 2\text{V}$		± 80	± 300 ± 380	mV
+PSRR	+Power Supply Rejection Ratio (Note 10)	Input Referred, 1V change, $V_G = 2.2\text{V}$		-69	-47 -45	dB
-PSRR	-Power Supply Rejection Ratio (Note 10)	Input Referred, 1V change, $V_G = 2.2\text{V}$		-58	-41 -40	dB
CMRR	Common Mode Rejection Ratio (Note 9)	Input Referred, $V_G = 2\text{V}$ $-1.8\text{V} < V_{\text{CM}} < 1.8\text{V}$		-72		dB
I_{S}	Supply Current	No Load		27	38 41	mA
		$V_S = \pm 2.5\text{V}$, $R_L = \text{Open}$		9.3	16 19	

Electrical Characteristics (Note 2) (Continued)

- Note 1:** Absolute Maximum Ratings indicate limits beyond which damage to the device may occur. Operating Ratings indicate conditions for which the device is intended to be functional, but specific performance is not guaranteed. For guaranteed specifications, see the Electrical Characteristics tables.
- Note 2:** Electrical Table values apply only for factory testing conditions at the temperature indicated. Factory testing conditions result in very limited self-heating of the device such that $T_J = T_A$. No guarantee of parametric performance is indicated in the electrical tables under conditions of internal self-heating where $T_J > T_A$.
- Note 3:** The maximum output current (I_{OUT}) is determined by device power dissipation limitations or value specified, whichever is lower.
- Note 4:** Human body model: 1.5k Ω in series with 100pF. Machine model: 0 Ω in series with 200pF.
- Note 5:** Slew Rate is the average of the rising and falling rates.
- Note 6:** Typical values represent the most likely parametric norm. Bold numbers refer to over temperature limits.
- Note 7:** Positive current corresponds to current flowing in the device.
- Note 8:** Drift determined by dividing the change in parameter distribution average at temperature extremes by the total temperature change.
- Note 9:** CMRR definition: $[\Delta V_{OUT}/\Delta V_{CM}] / A_V$ with 0.1V differential input voltage.
- Note 10:** +PSRR definition: $[\Delta V_{OUT}/\Delta V^+]$ / A_V , -PSRR definition: $[\Delta V_{OUT}/\Delta V^-]$ / A_V with 0.1V differential input voltage.
- Note 11:** Gain/Phase normalized to low frequency value at 25°C.
- Note 12:** Gain/Phase normalized to low frequency value at each A_V .
- Note 13:** Gain Control Frequency Response Schematic:

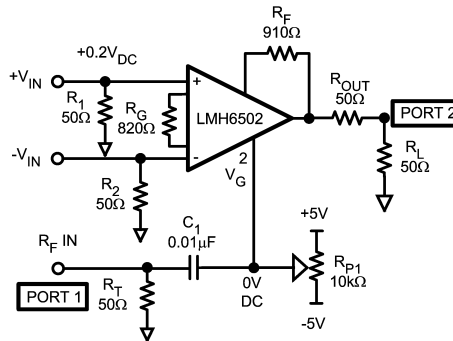

20067738

- Note 14:** Flat Band Attenuation (Relative to Max Gain) Range Definition: Specified as the attenuation range from maximum which allows gain flatness specified (either ± 0.2 dB or ± 0.1 dB) relative to A_{VMAX} gain. For example, for $f < 30$ MHz, here are the Flat Band Attenuation ranges:
 ± 0.2 dB 20dB down to 4dB = 16dB range
 ± 0.1 dB 20dB down to 12.5 dB = 7.5dB range

Connection Diagram

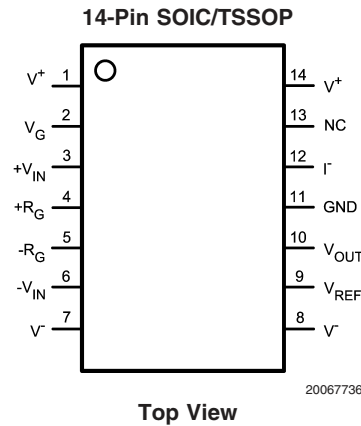

20067736

Ordering Information

Package	Part Number	Package Marking	Transport Media	NSC Drawing
14-pin SOIC	LMH6502MA	LMH6502MA	55 Units/Rail	M14A
	LMH6502MAX		2.5k Units Tape and Reel	
14-Pin TSSOP	LMH6502MT	LMH6502MT	94 Units/Rail	MTC14
	LMH6502MTX		2.5k Units Tape and Reel	

Typical Performance Characteristics Unless otherwise specified: $V_S = \pm 5V$, $25^\circ C$, $V_G = V_{GMAX}$, $V_{CM} = 0V$, $R_F = 1k\Omega$, $R_G = 174\Omega$, both inputs terminated in 50Ω , $R_L = 100\Omega$, Typical values, results referred to device output.

Small Signal Frequency for Various V_G

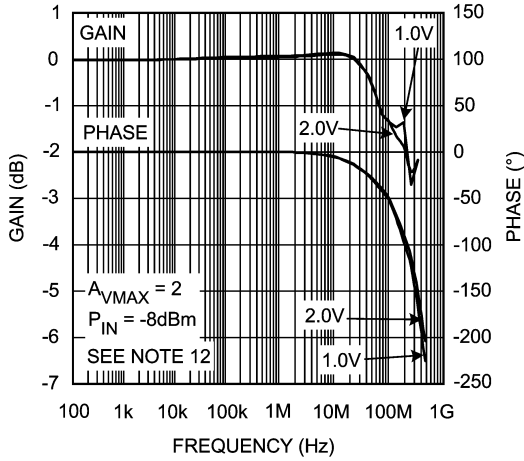

20067731

Large Signal Frequency for Various V_G

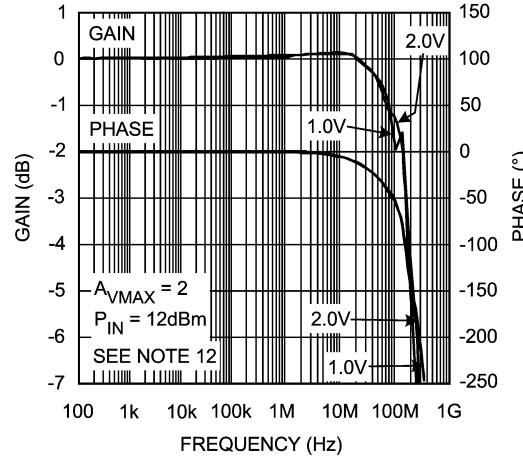

20067732

Frequency Response Over Temperature ($A_V = 10$)

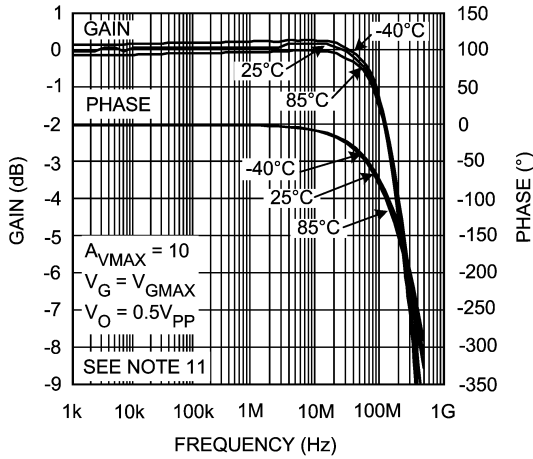

20067707

Frequency Response for Various V_G ($A_{VMAX} = 10$)

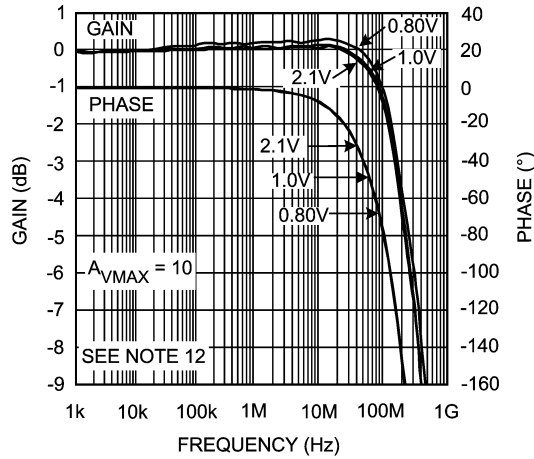

20067708

Frequency Response for Various V_G ($A_{VMAX} = 10$) ($\pm 2.5V$)

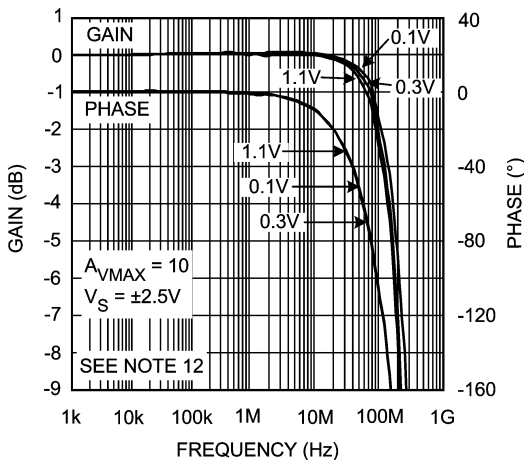

20067714

Small Signal Frequency Response for Various A_{VMAX}

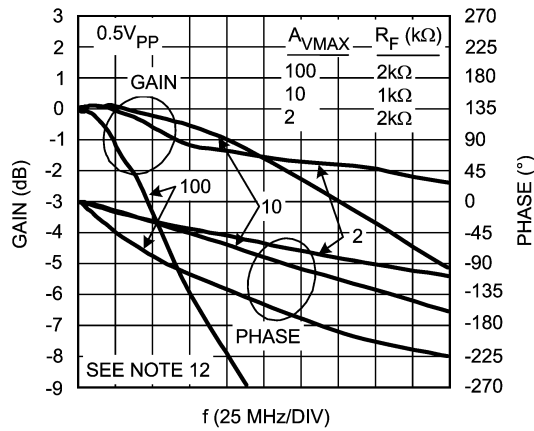

20067723

Typical Performance Characteristics Unless otherwise specified: $V_S = \pm 5V$, $25^\circ C$, $V_G = V_{GMAX}$, $V_{CM} = 0V$, $R_F = 1k\Omega$, $R_G = 174\Omega$, both inputs terminated in 50Ω , $R_L = 100\Omega$, Typical values, results referred to device output. (Continued)

Large Signal Frequency Response for Various A_{VMAX}

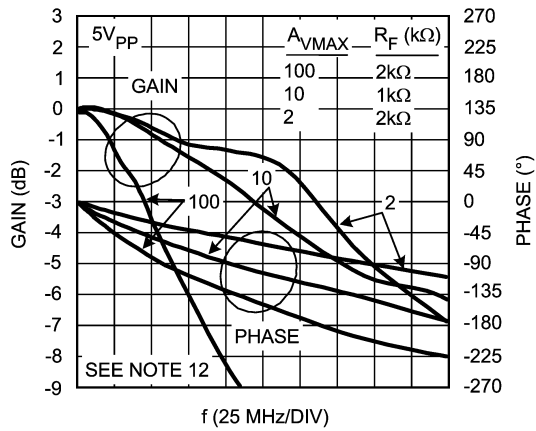

20067724

Frequency Response for Various V_G ($A_{VMAX} = 100$) (Small Signal)

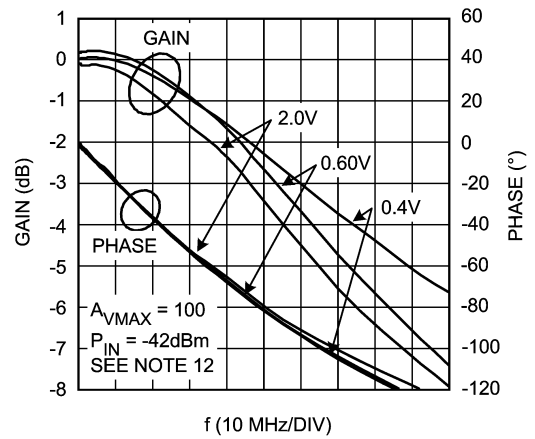

20067729

Frequency Response for Various V_G ($A_{VMAX} = 100$) (Large Signal)

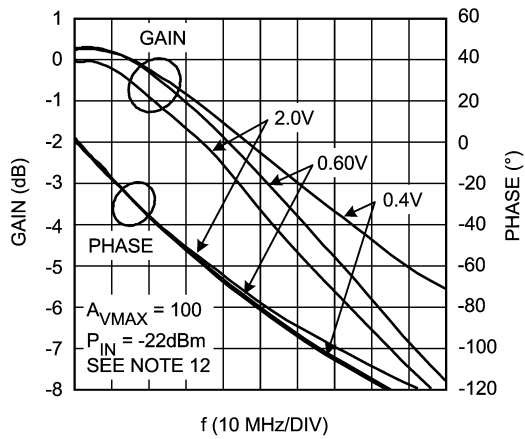

20067730

I_S vs. V_S

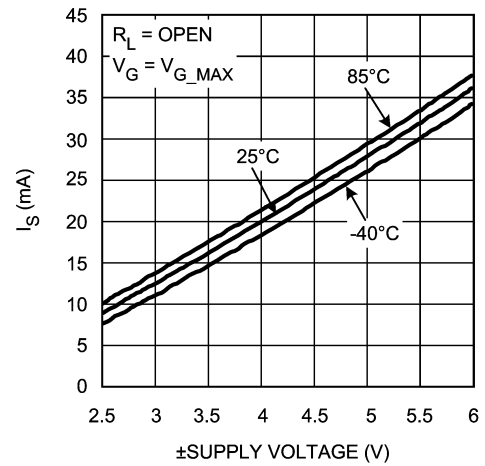

20067750

I_S vs. V_S

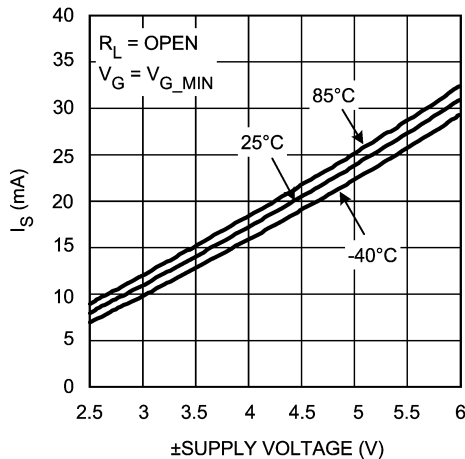

20067751

Input Bias Current vs. V_S

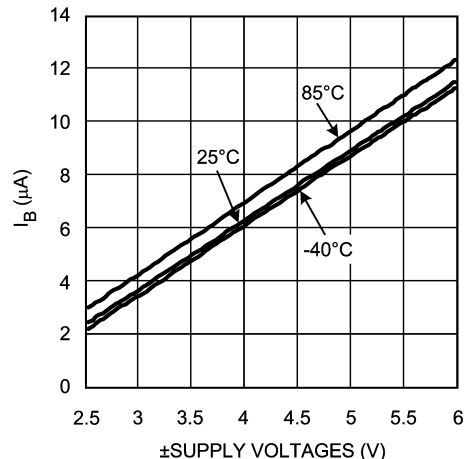

20067752

Typical Performance Characteristics Unless otherwise specified: $V_S = \pm 5V$, $25^\circ C$, $V_G = V_{GMAX}$, $V_{CM} = 0V$, $R_F = 1k\Omega$, $R_G = 174\Omega$, both inputs terminated in 50Ω , $R_L = 100\Omega$, Typical values, results referred to device output. (Continued)

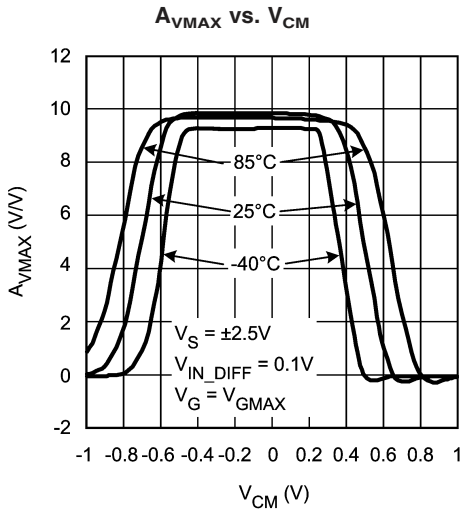

20067767

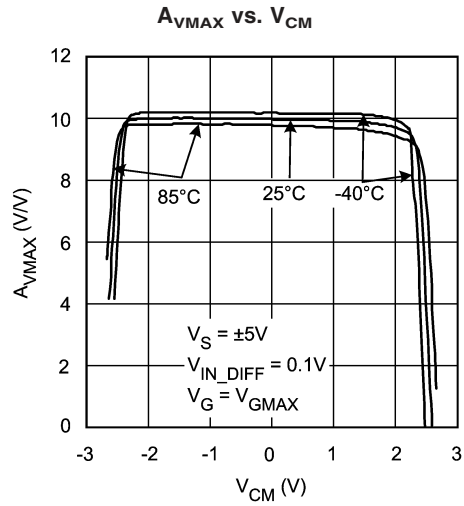

20067766

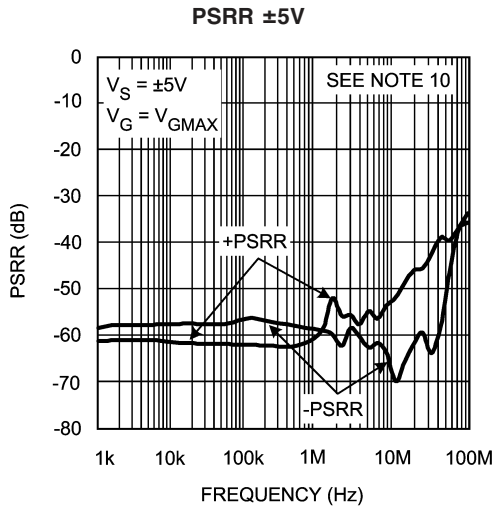

20067703

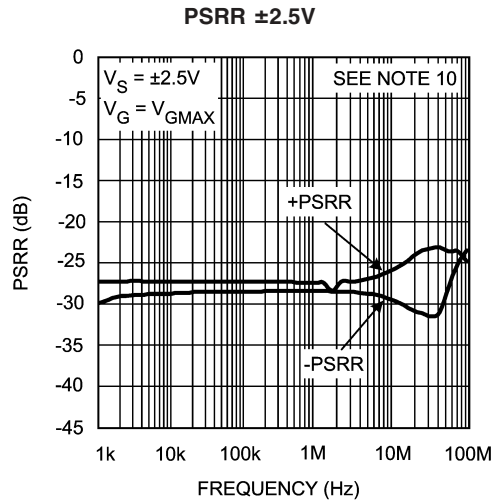

20067704

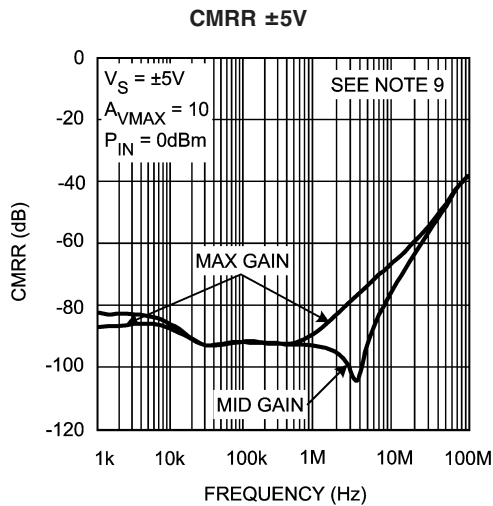

20067701

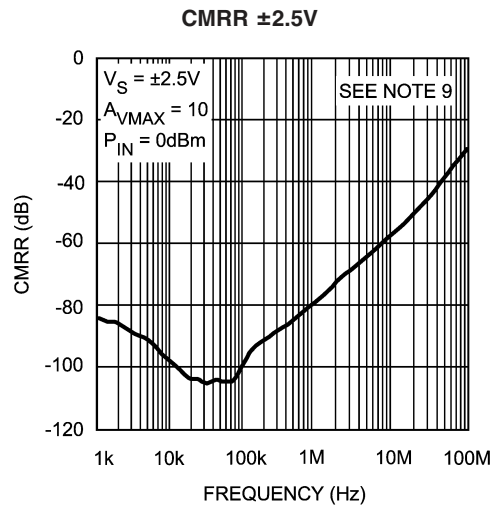

20067702

Typical Performance Characteristics Unless otherwise specified: $V_S = \pm 5V$, $25^\circ C$, $V_G = V_{GMAX}$, $V_{CM} = 0V$, $R_F = 1k\Omega$, $R_G = 174\Omega$, both inputs terminated in 50Ω , $R_L = 100\Omega$, Typical values, results referred to device output. (Continued)

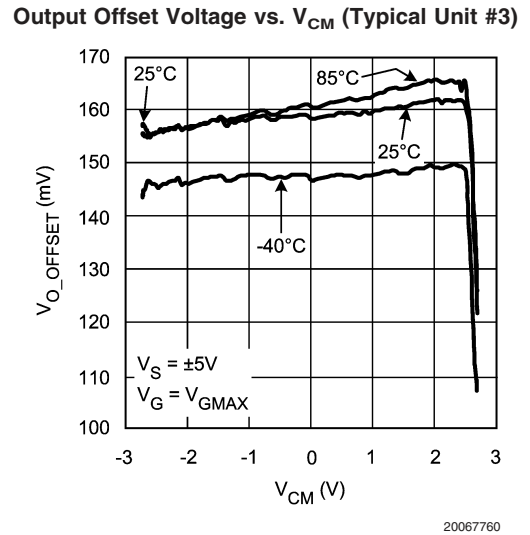
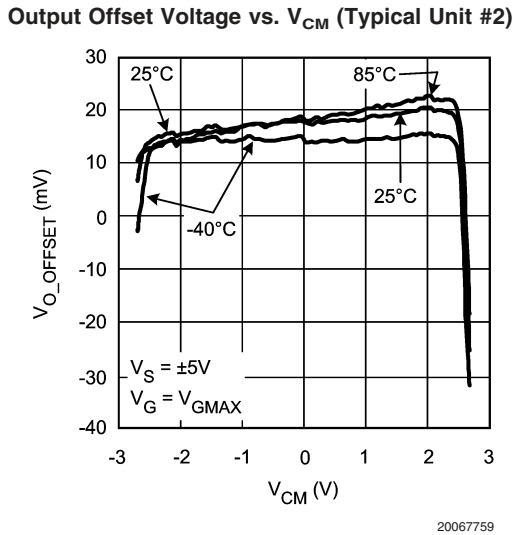
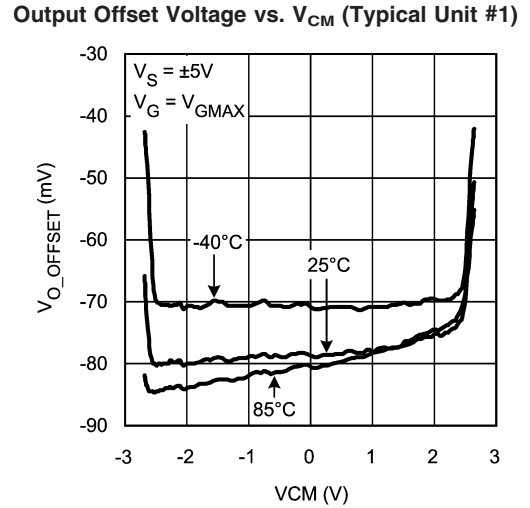
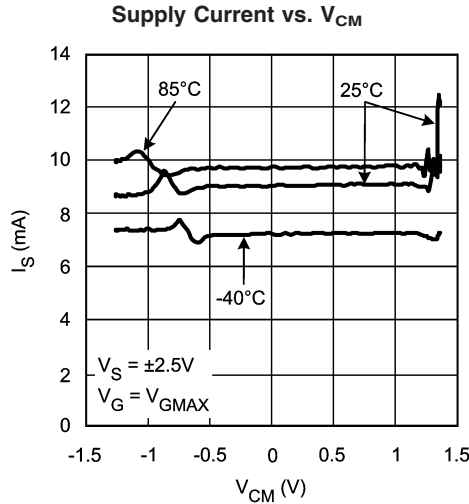
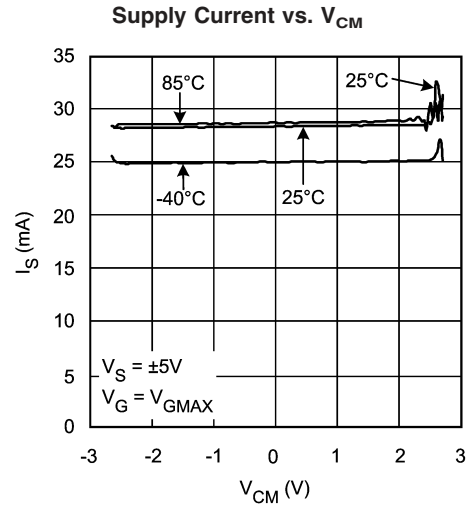
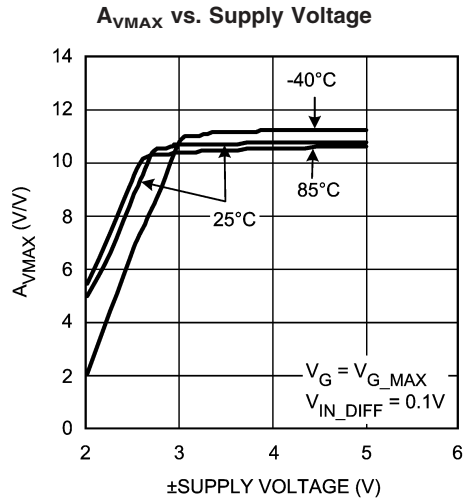

Typical Performance Characteristics Unless otherwise specified: $V_S = \pm 5V$, $25^\circ C$, $V_G = V_{GMAX}$, $V_{CM} = 0V$, $R_F = 1k\Omega$, $R_G = 174\Omega$, both inputs terminated in 50Ω , $R_L = 100\Omega$, Typical values, results referred to device output. (Continued)

Feed through Isolation

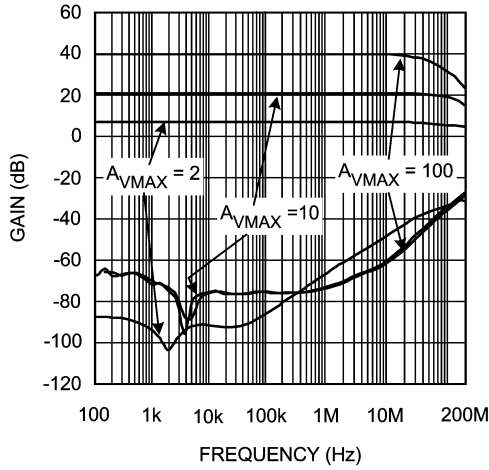

20067721

Gain Flatness and Linear Phase Deviation vs. V_G

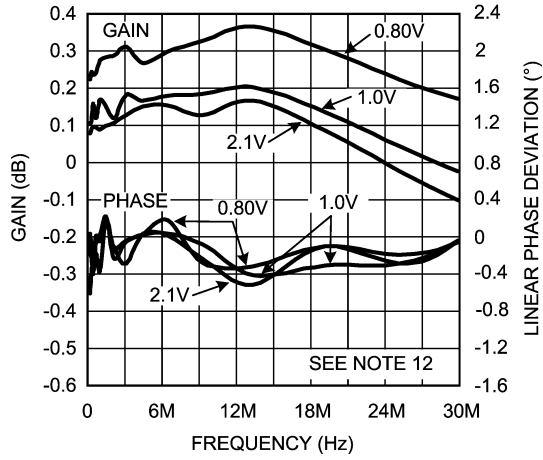

20067709

Gain Flatness Frequency vs. Gain (Note 14)

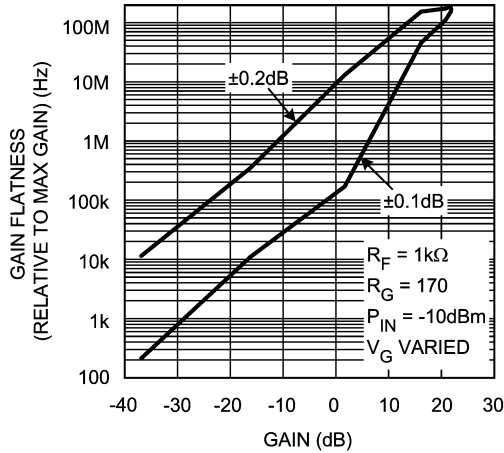

20067711

Group Delay vs. Frequency

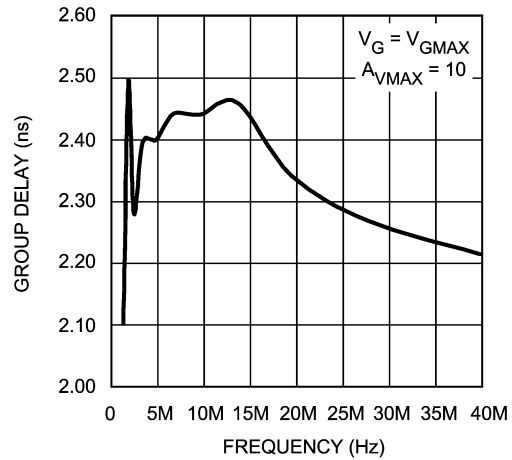

20067712

K Factor vs. R_G

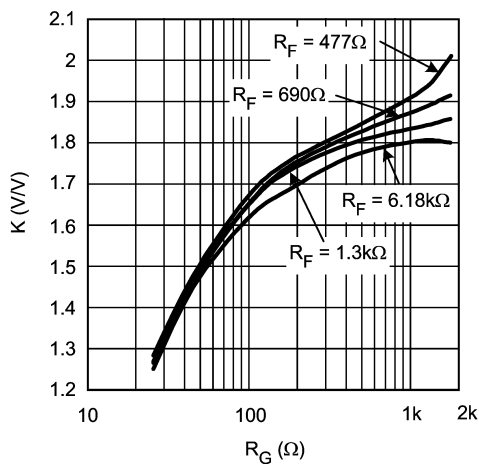

20067739

Gain vs. V_G Including Limits

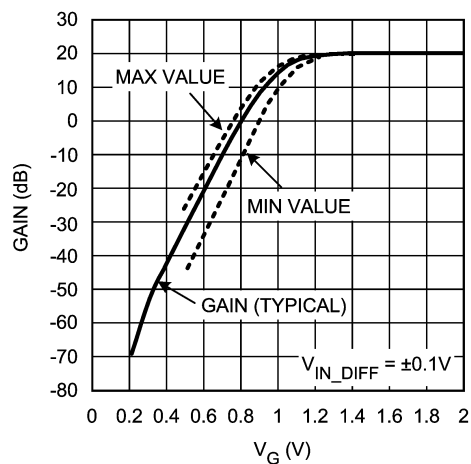

20067705

Typical Performance Characteristics Unless otherwise specified: $V_S = \pm 5V$, $25^\circ C$, $V_G = V_{GMAX}$, $V_{CM} = 0V$, $R_F = 1k\Omega$, $R_G = 174\Omega$, both inputs terminated in 50Ω , $R_L = 100\Omega$, Typical values, results referred to device output. (Continued)

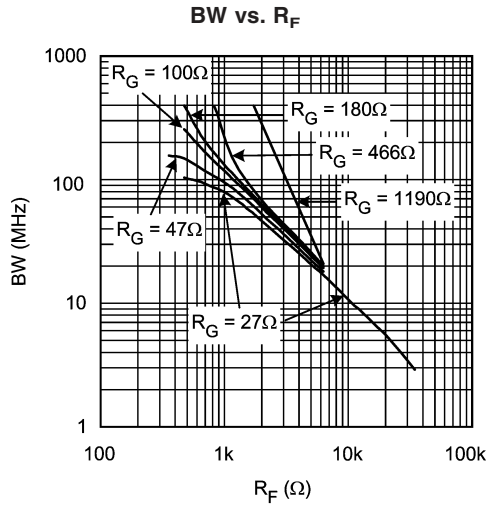

20067740

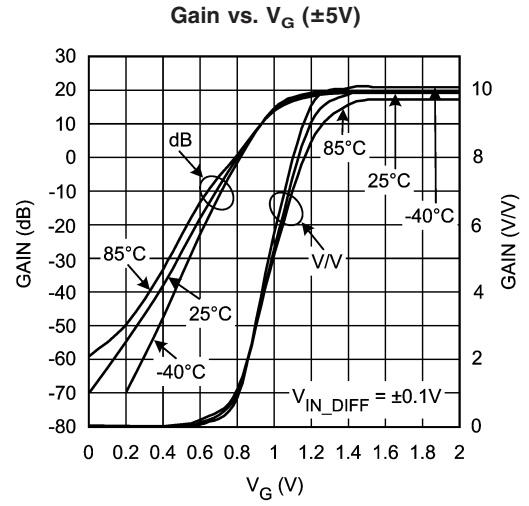

20067706

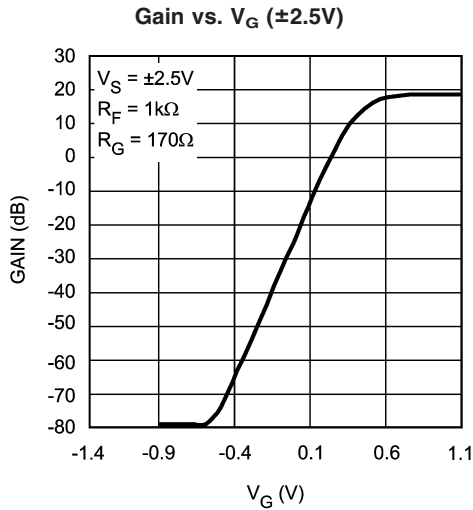

20067713

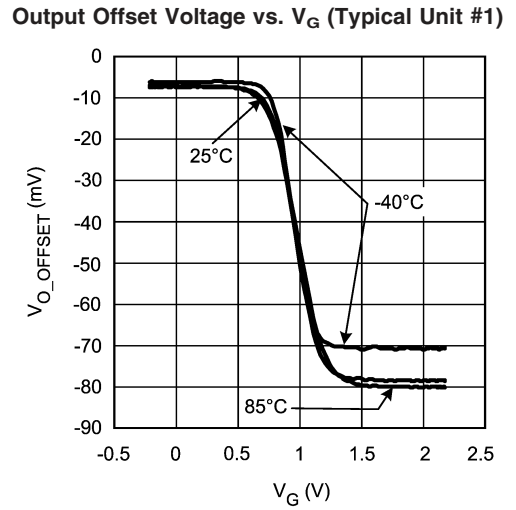

20067753

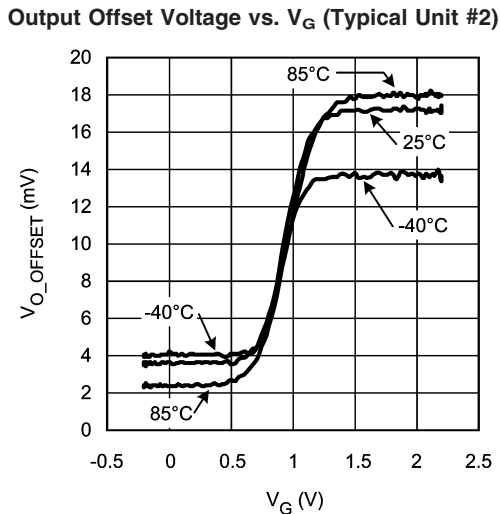

20067754

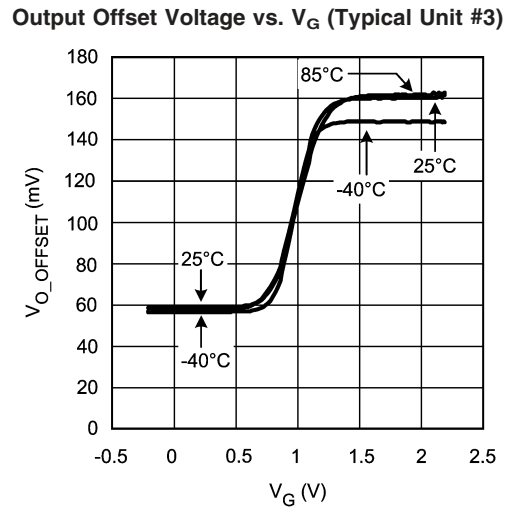

20067755

Typical Performance Characteristics Unless otherwise specified: $V_S = \pm 5V$, $25^\circ C$, $V_G = V_{GMAX}$, $V_{CM} = 0V$, $R_F = 1k\Omega$, $R_G = 174\Omega$, both inputs terminated in 50Ω , $R_L = 100\Omega$, Typical values, results referred to device output. (Continued)

Output Offset Voltage vs. $\pm V_S$ for various V_G (Typical Unit# 1)

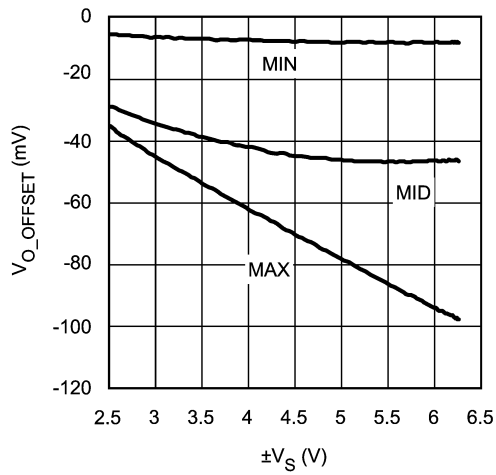

20067761

Output Offset Voltage vs. $\pm V_S$ for various V_G (Typical Unit# 2)

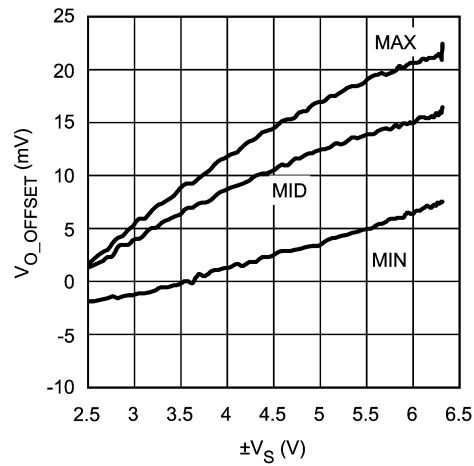

20067762

Output Offset Voltage vs. $\pm V_S$ for various V_G (Typical Unit# 3)

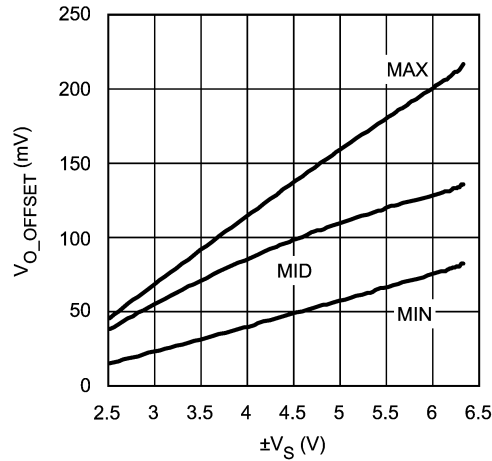

20067763

Noise vs. Frequency ($A_{VMAX} = 2$)

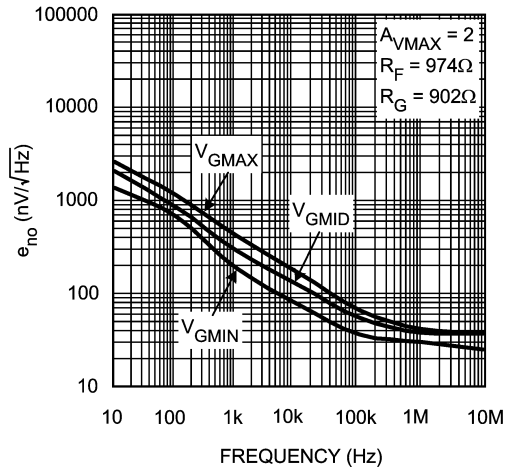

20067725

Noise vs. Frequency ($A_{VMAX} = 10$)

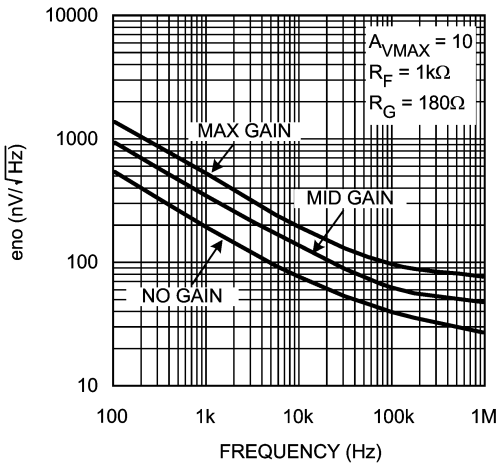

20067710

Noise vs. Frequency ($A_{VMAX} = 100$)

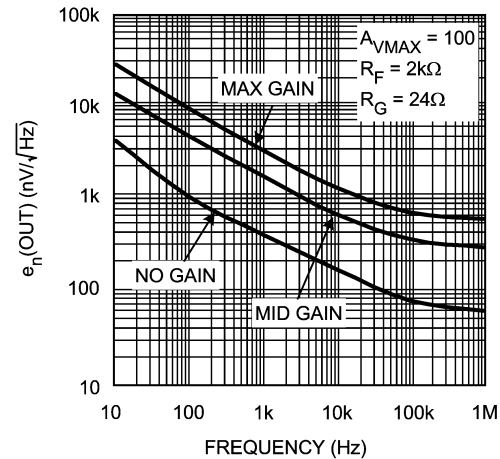

20067717

Typical Performance Characteristics Unless otherwise specified: $V_S = \pm 5V$, $25^\circ C$, $V_G = V_{GMAX}$, $V_{CM} = 0V$, $R_F = 1k\Omega$, $R_G = 174\Omega$, both inputs terminated in 50Ω , $R_L = 100\Omega$, Typical values, results referred to device output. (Continued)

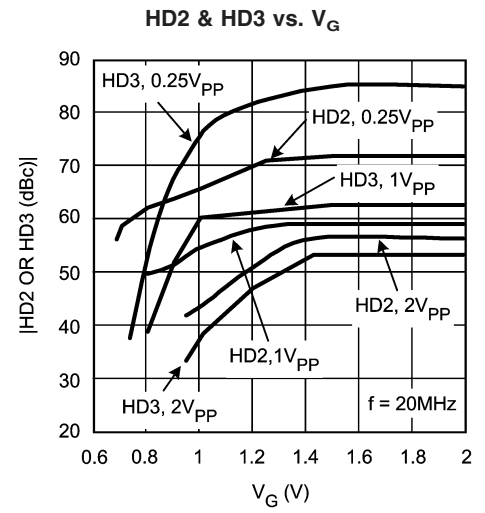
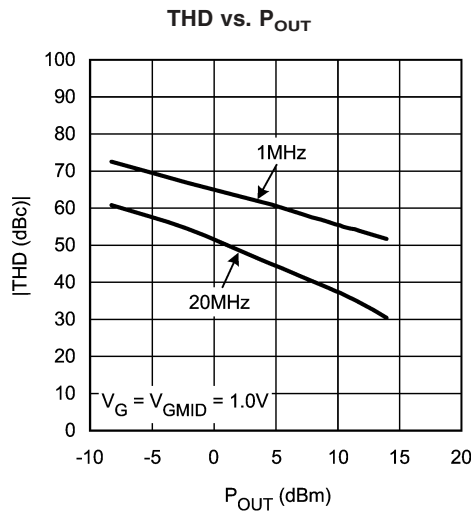
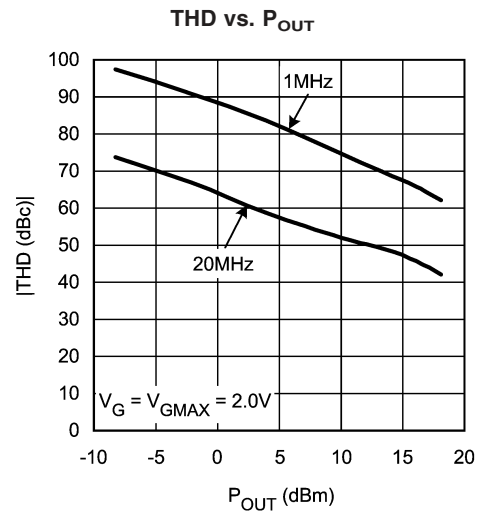
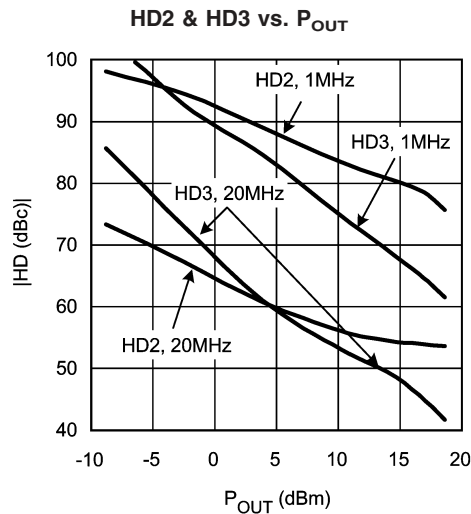
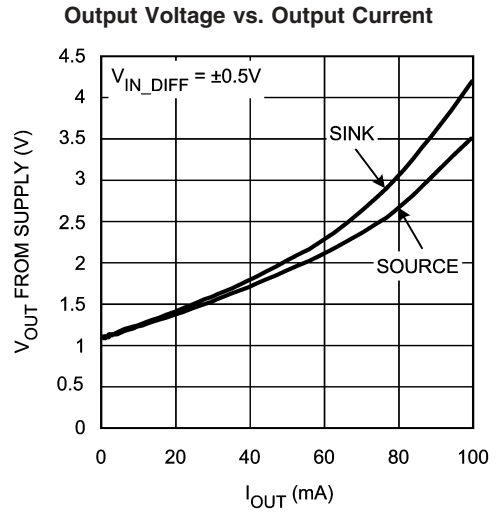
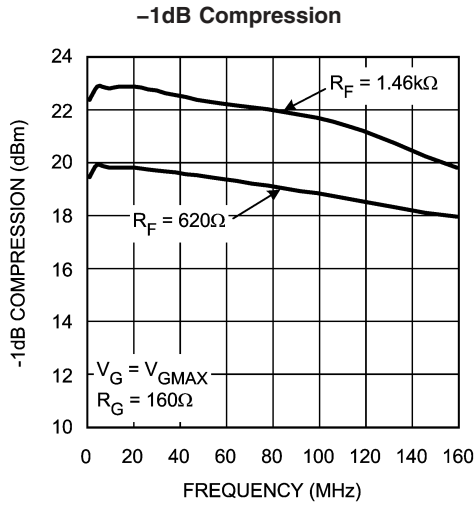

Typical Performance Characteristics Unless otherwise specified: $V_S = \pm 5V$, $25^\circ C$, $V_G = V_{GMAX}$, $V_{CM} = 0V$, $R_F = 1k\Omega$, $R_G = 174\Omega$, both inputs terminated in 50Ω , $R_L = 100\Omega$, Typical values, results referred to device output. (Continued)

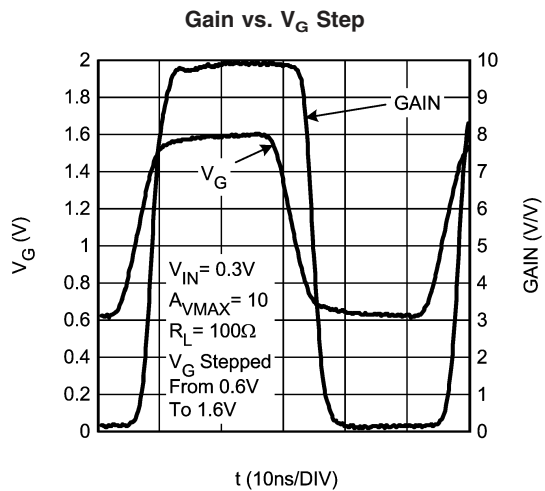
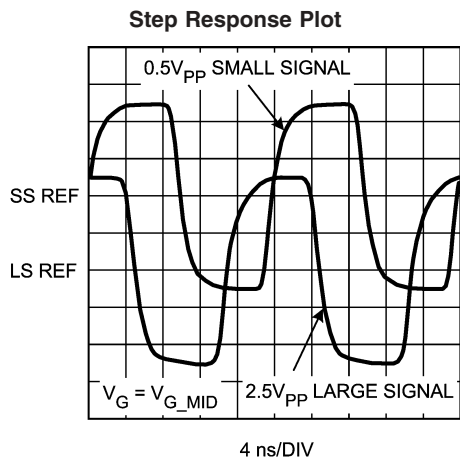
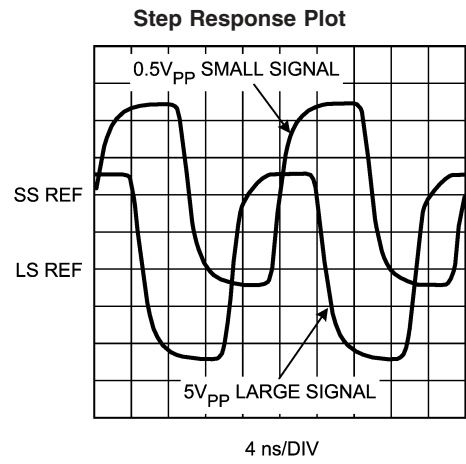
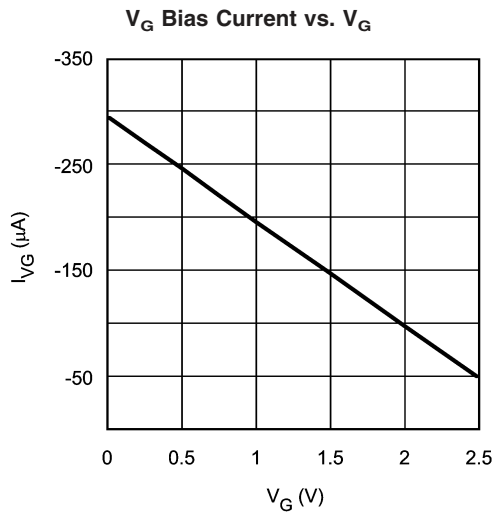
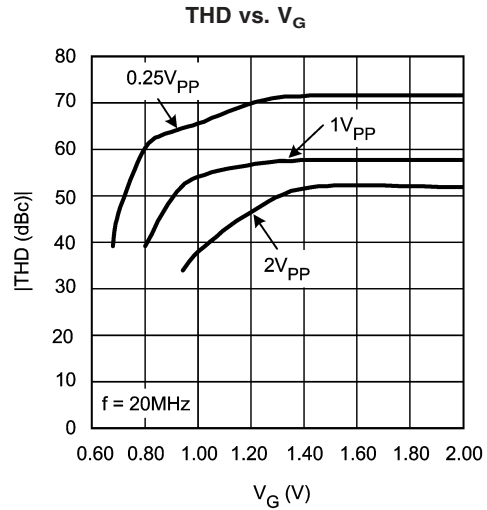
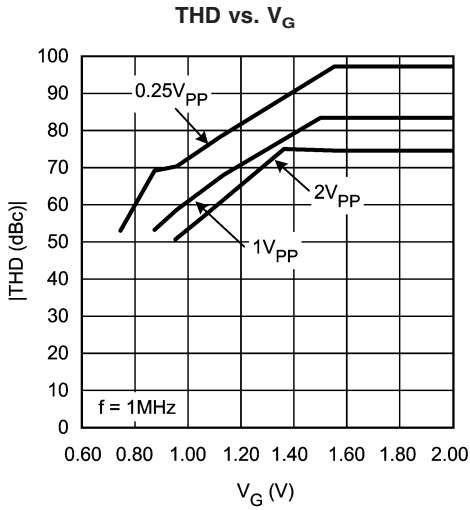

Typical Performance Characteristics Unless otherwise specified: $V_S = \pm 5V$, $25^\circ C$, $V_G = V_{GMAX}$, $V_{CM} = 0V$, $R_F = 1k\Omega$, $R_G = 174\Omega$, both inputs terminated in 50Ω , $R_L = 100\Omega$, Typical values, results referred to device output. (Continued)

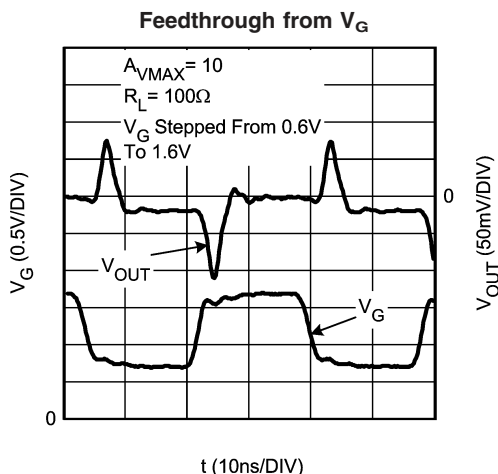

20067765

Application Information

THEORY OF OPERATION

A simplified schematic is shown in *Figure 1*. $+V_{IN}$ and $-V_{IN}$ are buffered with closed loop voltage followers inducing a signal current in R_G proportional to $(+V_{IN}) - (-V_{IN})$, the differential input voltage. This current controls a current source which supplies two well-matched transistor, Q1 and Q2.

The current flowing through Q2 is converted to the final output voltage using R_F and the output amplifier, U1. By changing the fraction of the signal current "I" which flows through Q2, the gain is changed. This is done by changing the voltage applied differentially to the bases of Q1 and Q2. For example, with $V_G = 0V$, Q1 conducts heavily and Q2 is off. With none of "I" flowing through R_F , the LMH6502's input to output gain is strongly attenuated. With $V_G = +2V$, Q1 is off and the entire signal current flows through Q2 to R_F producing maximum gain. With V_G set to 1V, the bases of Q1 and Q2 are set to approximately the same voltage, Q1 and Q2 have the same collector currents - equal to one half of the signal current "I", thus the gain is approximately one half the maximum gain.

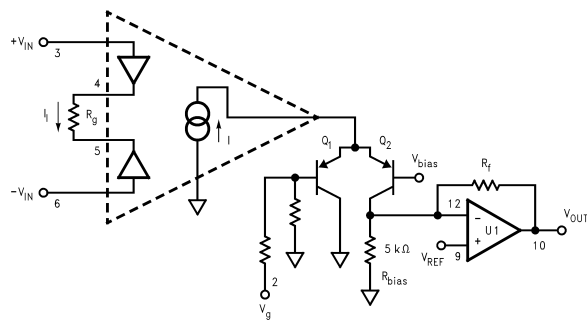

20067741

FIGURE 1. LMH6502 Block Diagram

CHOOSING R_F & R_G

Maximum input amplitude and maximum gain are the two key specifications that determine component values in a LMH6502 application.

The output stage op amp is a current-feedback type amplifier optimized for $R_F = 1k\Omega$. R_G can then be computed as:

$$R_G = \frac{R_F \times 1.72}{A_{VMAX}} - 3\Omega \text{ WITH } R_F = 1K\Omega \quad (1)$$

To determine whether the maximum input amplitude will overdrive the LMH6502, compute:

$$V_{DMAX} = (R_G + 3.0\Omega) \times 1.70mA \quad (2)$$

the maximum differential input voltage for linear operation. If the maximum input amplitude exceeds the above V_{DMAX} limit, then LMH6502 should either be moved to a location in the signal chain where input amplitudes are reduced, or the LMH6502 gain A_{VMAX} should be reduced or the values for R_G and R_F should be increased. The overall system performance impact is different based on the choice made. If the input amplitude is reduced, re-compute the impact on signal-to-noise ratio. If A_{VMAX} is reduced, post LMH6502 amplifier gain, should be increased, or another gain stage added to make up for reduced system gain. To increase R_G and R_F , compute the lowest acceptable value for R_G :

$$R_G > 590 \times V_{DMAX} - 3\Omega \quad (3)$$

Operating with R_G larger than this value insures linear operation of the input buffers.

R_F may be computed from selected R_G and A_{VMAX} : R_F should be $\geq 1k\Omega$ for overall best performance, however $R_F < 1k\Omega$ can be implemented if necessary using a loop gain reducing resistor to ground on the inverting summing node of the output amplifier (see application note QA-13 for details).

ADJUSTING OFFSET

Offset can be broken into two parts; an input-referred term and an output-referred term. The input-referred offset shows up as a variation in output voltage as V_G is changed. This can be trimmed using the circuit in *Figure 2* by placing a low frequency square wave ($V_{LOW} = 0V$, $V_{HIGH} = 2V$ into V_G with

Application Information (Continued)

$V_{IN} = 0V$, the input referred V_{OS} term shows up as a small square wave riding a DC value. Adjust R_{10} to null the V_{OS} square wave term to zero. After adjusting the input-referred offset, adjust R_{14} (with $V_{IN} = 0$, $V_G = 0$) until V_{OUT} is zero. Finally, for inverting applications V_{IN} may be applied to pin 6 and the offset adjustment to pin 3. These steps will minimize the output offset voltage. However, since the offset term itself varies with the gain setting, the correction is not perfect and some residual output offset will remain at in-between V_G 's. Also, this offset trim does not improve output offset temperature coefficient.

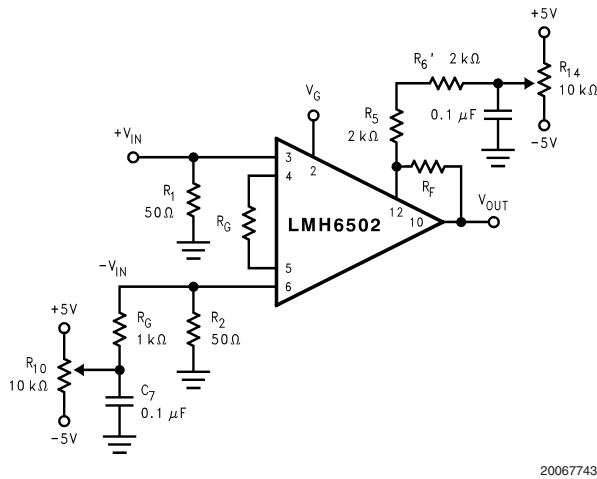

20067743

FIGURE 2. Nulling the output offset voltage

GAIN ACCURACY

Defined as the actual gain compared against the theoretical gain at a certain V_G (results expressed in dB).

Theoretical gain is given by:

$$A(V/V) = K \times \frac{R_F}{R_G} \times \frac{1}{1 + e^{\left[\frac{1 - V_G}{V_C} \right]}} \quad (4)$$

Where $K = 1.72$ (nominal) & $V_C = 90mV$ @ room temperature.

For a V_G range, the value specified in the tables represents the worst case accuracy over the entire range. The "Typical" value would be the worst case difference between the "Typical Gain" and the "Theoretical gain". The "Max" value would be the worst case difference between the max/min gain limit and the "Theoretical gain".

GAIN MATCHING

Defined as the limit on gain variation at a certain V_G (expressed in dB). Specified as "Max" only (no "Typical"). For a V_G range, the value specified represents the worst case matching over the entire range. The "Max" value would be the worst case difference between the max/min gain limit and the typical gain.

NOISE

Figure 3 describes the LMH6502's output-referred spot noise density as a function of frequency with $A_{VMAX} = 10V/V$. The plot includes all the noise contributing terms. However, with both inputs terminated in 50Ω , the input noise contribution is minimal. At $A_{VMAX} = 10V/V$, the LMH6502 has a typical input-referred spot noise density (e_{in}) of $7.7nV/\sqrt{Hz}$ flat-band. For applications extending well into the flat-band region, the input RMS voltage noise can be determined from the following single-pole model:

$$V_{RMS} = e_{in} * \sqrt{1.57 * (-3dB \text{ BANDWIDTH})} \quad (5)$$

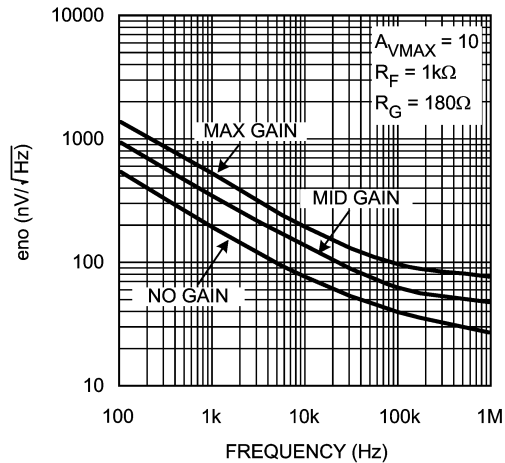

20067710

FIGURE 3. Output Referred Voltage Noise vs. Frequency

CIRCUIT LAYOUT CONSIDERATIONS & EVALUATION BOARD

A good high frequency PCB layout including ground plane construction and power supply bypassing close to the package are critical to achieving full performance. The amplifier is sensitive to stray capacitance to ground at the I^- input (pin 12); keep node trace area small. Shunt capacitance across the feedback resistor should not be used to compensate for this effect. For best performance at low maximum gains ($A_{VMAX} < 10$) $+R_G$ and $-R_G$ connections should be treated in a similar fashion. Capacitance to ground should be minimized by removing the ground plane from under the body of R_G . Parasitic or load capacitance directly on the output (pin 10) degrades phase margin leading to frequency response peaking.

The LMH6502 is fully stable when driving a 100Ω load. With reduced load (e.g. $1k\Omega$) there is a possibility of instability at very high frequencies beyond $400MHz$ especially with a capacitive load. When the LMH6502 is connected to a light load as such, it is recommended to add a snubber network to the output (e.g. 100Ω and $39pF$ in series tied between the LMH6502 output and ground). C_L can also be isolated from the output by placing a small resistor in series with the output (pin 10).

Component parasitics also influence high frequency results. Therefore it is recommended to use metal film resistors such as RN55D or leadless components such as surface mount devices. High profile sockets are not recommended.

Application Information (Continued)

National Semiconductor suggests the following evaluation boards as a guide for high frequency layout and as an aid in device testing and characterization:

Device	Package	Evaluation Board Part Number
LMH6502MA	SOIC-14	CLC730033
LMH6502MT	TSSOP-14	CLC730146

The evaluation board is shipped when a device sample request is placed with National Semiconductor

SINGLE SUPPLY OPERATION

It is possible to operate the LMH6502 with a single supply. To do so, tie pin 11 (GND) to a potential about mid point between V^+ and V^- . Two examples are shown in *Figure 4* & *Figure 5*.

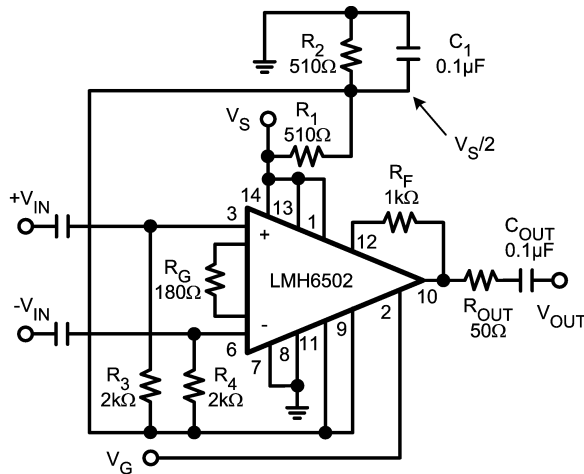

20067746

FIGURE 4. AC Coupled Single Supply VGA

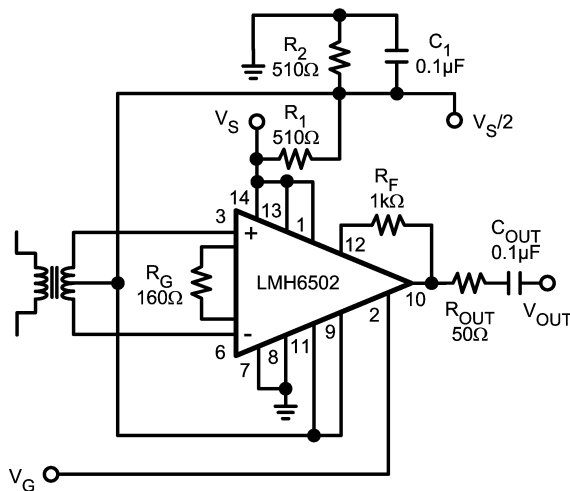

20067747

FIGURE 5. Transformer Coupled Single Supply VGA

OPERATING AT LOWER SUPPLY VOLTAGES

The LMH6502 is rated for operation down to 5V supplies (V^+ - V^-). There are some specifications shown for operation at $\pm 2.5V$ within the data sheet (i.e. Frequency Response, CMRR, PSRR, Gain vs. V_G , etc.). Compared to $\pm 5V$ operation, at lower supplies:

a) V_G range shifts lower.

Here are the approximate expressions for various V_G voltages as a function of V^+ :

TABLE 1. V_G Definition Based on V^+

V_G	Definition	Expression (V)
V_{G_MIN}	Gain Cut-off	$0.2 \times V^+ - 1$
V_{G_MID}	$A_{VMAX}/2$	$0.2 \times V^+$
V_{G_MAX}	A_{VMAX}	$0.2 \times V^+ + 1$

- b) V_{G_LIMIT} (maximum permissible voltage on V_G) is reduced. This is due to limitations within the device arising from transistor headroom. Beyond this limit, device performance will be affected (non-destructive). This could reveal itself as premature high frequency response roll-off. With $\pm 2.5V$ supplies, V_{G_LIMIT} is below 1.1V whereas $V_G = 1.5V$ is needed to get maximum gain. This means that operating under these conditions has reduced the maximum permissible voltage on V_G to a level below what is needed to get Max gain. If supply voltages are asymmetrical with V^+ being lower, further "pinching" of V_G range could result; for example, with $V^+ = 2V$, and $V^- = -3V$, $V_{G_LIMIT} = 0.40V$ which results in maximum gain being 2.5dB less than what would be expected when V_S is higher.
- c) "Max_gain" reduces. There is an intrinsic reduction in max gain when the total supply voltage is reduced (see Typical Performance Characteristics plots for Gain vs. V_G ($V_S = \pm 2.5V$)). In addition, there is the more drastic mechanism described in "b" above. Beyond V_{G_LIMIT} , high frequency response is also effected.

Application Circuits

AGC LOOP

Figure 6 shows a typical AGC circuit. The LMH6502 is followed up with a LMH6714 for higher overall gain. The output of the LMH6714 is rectified and fed to an inverting integrator using a LMH6657 (wideband voltage feedback op amp). When the output voltage, V_{OUT} , is too large the integrator output voltage ramps down reducing the net gain of the LMH6502 and V_{OUT} . If the output voltage is too small, the integrator ramps up increasing the net gain and the output voltage. Actual output level is set with R_1 . To prevent shifts in DC output voltage with DC changes in input signal level, trim pot R_2 is provided. AGC circuits are always limited in the range of input signals over which constant output level can be maintained. In this circuit, we would expect that reasonable AGC action could be maintained for at least 40dB. In practice, rectifier dynamic range limits reduce this slightly.

Application Circuits (Continued)

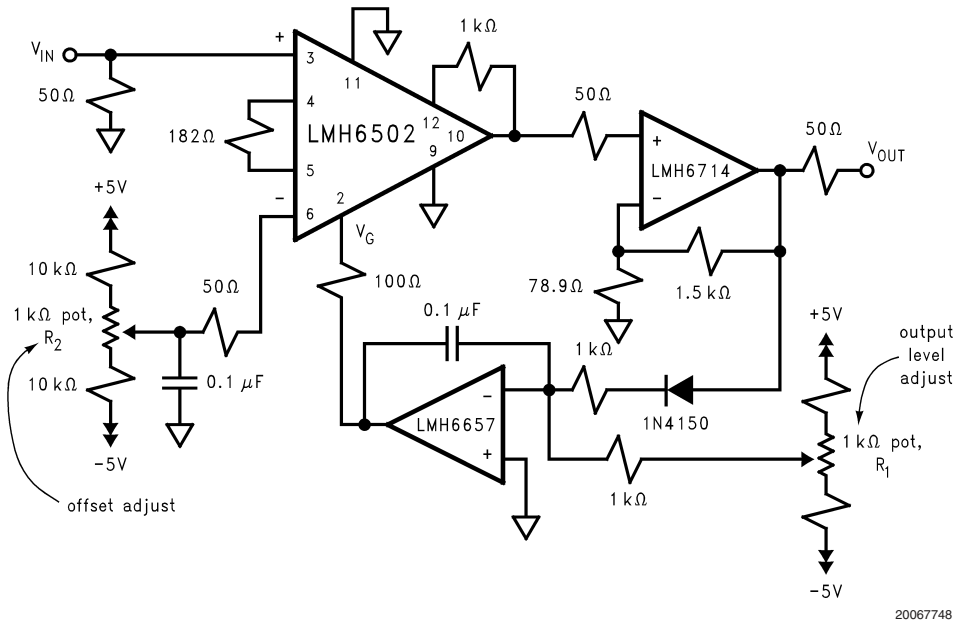

FIGURE 6. Automatic Gain Control (AGC) Loop

FREQUENCY SHAPING

Frequency Shaping Frequency shaping and bandwidth extension of the LMH6502 can be accomplished using parallel networks connected across the R_G ports. The network shown in the *Figure 7* schematic will effectively extend the LMH6502's bandwidth.

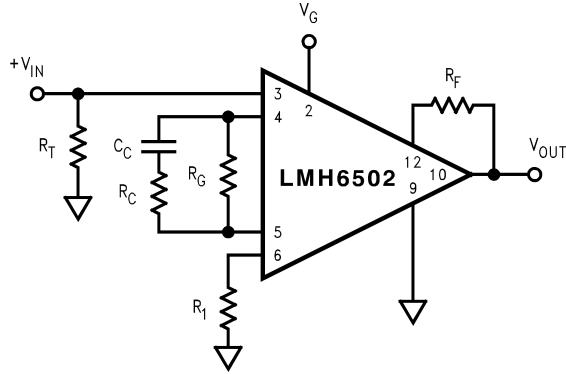
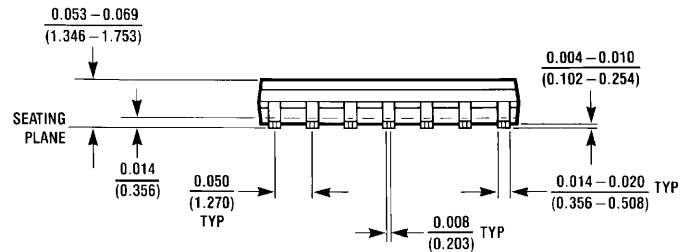
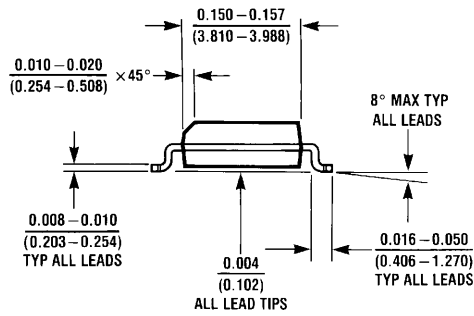
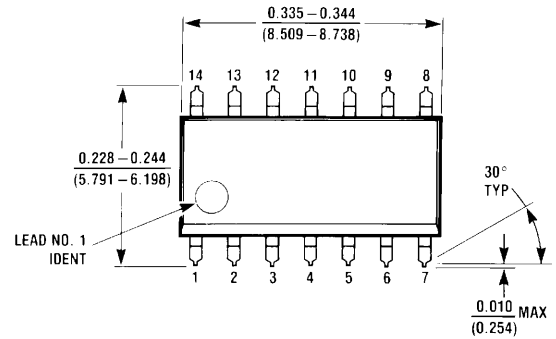

FIGURE 7. Frequency Shaping

Physical Dimensions inches (millimeters) unless otherwise noted



M14A (REV H)

**14-Pin SOIC
NS Package Number M14A**

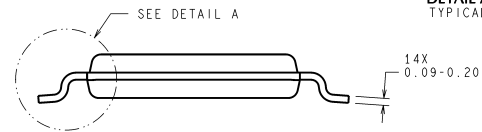
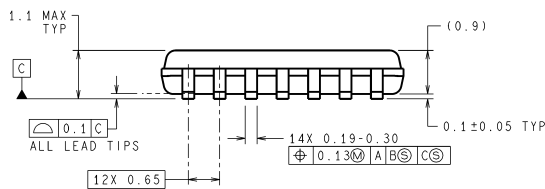
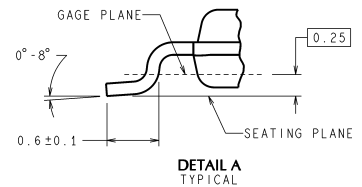
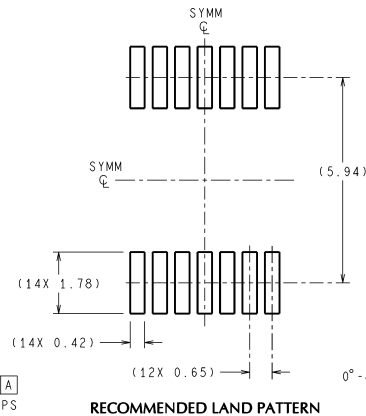
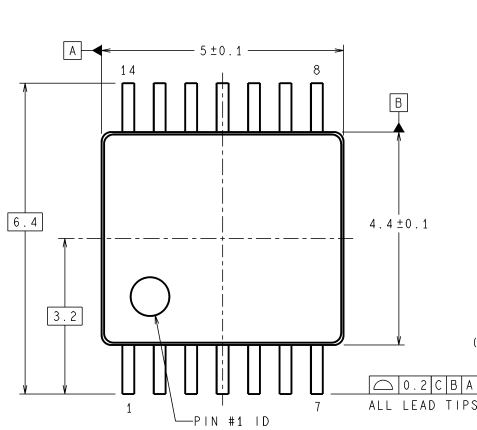

DIMENSIONS ARE IN MILLIMETERS
DIMENSIONS IN () FOR REFERENCE ONLY

MTC14 (Rev D)

**14-Pin TSSOP
NS Package Number MTC14**

Notes

LIFE SUPPORT POLICY

NATIONAL'S PRODUCTS ARE NOT AUTHORIZED FOR USE AS CRITICAL COMPONENTS IN LIFE SUPPORT DEVICES OR SYSTEMS WITHOUT THE EXPRESS WRITTEN APPROVAL OF THE PRESIDENT AND GENERAL COUNSEL OF NATIONAL SEMICONDUCTOR CORPORATION. As used herein:

- | | |
|----------------------------------------------------------------------------------------------------------------------------------------------------------------------------------------------------------------------------------------------------------------------------------------------------------------------------------------------------------|---------------------------------------------------------------------------------------------------------------------------------------------------------------------------------------------------------------------------------------------|
| <p>1. Life support devices or systems are devices or systems which, (a) are intended for surgical implant into the body, or (b) support or sustain life, and whose failure to perform when properly used in accordance with instructions for use provided in the labeling, can be reasonably expected to result in a significant injury to the user.</p> | <p>2. A critical component is any component of a life support device or system whose failure to perform can be reasonably expected to cause the failure of the life support device or system, or to affect its safety or effectiveness.</p> |
|----------------------------------------------------------------------------------------------------------------------------------------------------------------------------------------------------------------------------------------------------------------------------------------------------------------------------------------------------------|---------------------------------------------------------------------------------------------------------------------------------------------------------------------------------------------------------------------------------------------|

BANNED SUBSTANCE COMPLIANCE

National Semiconductor certifies that the products and packing materials meet the provisions of the Customer Products Stewardship Specification (CSP-9-111C2) and the Banned Substances and Materials of Interest Specification (CSP-9-111S2) and contain no "Banned Substances" as defined in CSP-9-111S2.



National Semiconductor
Americas Customer
Support Center
Email: new.feedback@nsc.com
Tel: 1-800-272-9959

National Semiconductor
Europe Customer Support Center
Fax: +49 (0) 180-530 85 86
Email: europe.support@nsc.com
Deutsch Tel: +49 (0) 69 9508 6208
English Tel: +44 (0) 870 24 0 2171
Français Tel: +33 (0) 1 41 91 8790

National Semiconductor
Asia Pacific Customer
Support Center
Email: ap.support@nsc.com

National Semiconductor
Japan Customer Support Center
Fax: 81-3-5639-7507
Email: jpn.feedback@nsc.com
Tel: 81-3-5639-7560

www.national.com