

# LMH6574

## 4:1 High Speed Video Multiplexer

### General Description

The LMH™6574 is a high performance analog multiplexer optimized for professional grade video and other high fidelity high bandwidth analog applications. The output amplifier selects any one of four buffered input signals based on the state of the two address bits. The LMH6574 provides a 400 MHz bandwidth at 2 V<sub>PP</sub> output signal levels. Multimedia and high definition television (HDTV) applications can benefit from the LMH6574's 0.1 dB bandwidth of 150 MHz and its 2200 V/μs slew rate.

The LMH6574 supports composite video applications with its 0.02% and 0.05° differential gain and phase errors for NTSC and PAL video signals while driving a single, back terminated 75Ω load. An 80 mA linear output current is available for driving multiple video load applications.

The LMH6574 gain is set by external feedback and gain set resistors for maximum flexibility.

The LMH6574 is available in the 14 pin SOIC package.

### Features

- 500 MHz, 500 mV -3 dB bandwidth, A<sub>V</sub>=2
- 400 MHz, 2V<sub>PP</sub> -3 dB bandwidth, A<sub>V</sub>=2
- 8 ns channel switching time
- 70 dB channel to channel isolation @ 10 MHz
- 0.02%, 0.05° diff. gain, phase
- 0.1 dB gain flatness to 150 MHz
- 2200 V/μs slew rate
- Wide supply voltage range: 6V (±3V) to 12V (±6V)
- -68 dB HD2 @ 5 MHz
- -84 dB HD3 @ 5 MHz

### Applications

- Video router
- Multi input video monitor
- Instrumentation / Test equipment
- Receiver IF diversity switch
- Multi Channel A/D Driver
- Picture in Picture video switch

### Connection Diagram

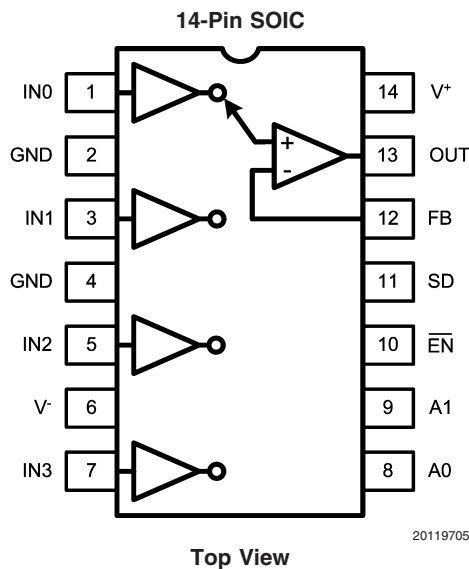

### Truth Table

| A1 | A0 | $\overline{\text{EN}}$ | SD | OUT      |
|----|----|------------------------|----|----------|
| 1  | 1  | 0                      | 0  | CH 3     |
| 1  | 0  | 0                      | 0  | CH2      |
| 0  | 1  | 0                      | 0  | CH1      |
| 0  | 0  | 0                      | 0  | CH 0     |
| X  | X  | 1                      | 0  | Disable  |
| X  | X  | X                      | 1  | Shutdown |

### Ordering Information

| Package     | Part Number | Package Marking | Transport Media          | NSC Drawing |
|-------------|-------------|-----------------|--------------------------|-------------|
| 14-Pin SOIC | LMH6574MA   | LH6574MA        | 55 Units/Rail            | M14A        |
|             | LMH6574MAX  |                 | 2.5k Units Tape and Reel |             |

LMH™ is a trademark of National Semiconductor Corporation.

**Absolute Maximum Ratings** (Note 1)

If Military/Aerospace specified devices are required, please contact the National Semiconductor Sales Office/Distributors for availability and specifications.

|                                  |                 |
|----------------------------------|-----------------|
| ESD Tolerance                    | (Note 4)        |
| Human Body Model                 | 2000V           |
| Machine Model                    | 200V            |
| Supply Voltage ( $V^+ - V^-$ )   | 13.2V           |
| $I_{OUT}$ (Note 3)               | 130 mA          |
| Signal & Logic Input Pin Voltage | $\pm(V_S+0.6V)$ |
| Signal & Logic Input Pin Current | $\pm 20$ mA     |
| Maximum Junction Temperature     | +150°C          |

|                                 |                 |
|---------------------------------|-----------------|
| Storage Temperature Range       | -65°C to +150°C |
| Soldering Information           |                 |
| Infrared or Convection (20 sec) | 235 °C          |
| Wave Soldering (10 sec)         | 260 °C          |

**Operating Ratings** (Note 1)

|                           |                   |                   |
|---------------------------|-------------------|-------------------|
| Operating Temperature     | -40 °C to 85 °C   |                   |
| Supply Voltage Range      | 6V to 12V         |                   |
| <b>Thermal Resistance</b> |                   |                   |
| Package                   | ( $\theta_{JA}$ ) | ( $\theta_{JC}$ ) |
| 14-Pin SOIC               | 130°C/W           | 40°C/W            |

**±5V Electrical Characteristics**

$V_S = \pm 5V$ ,  $R_L = 100\Omega$ ,  $A_V = 2$  V/V,  $T_J = 25$  °C, Unless otherwise specified. **Bold** numbers specify limits at temperature extremes.

| Symbol                              | Parameter                                      | Conditions (Note 2)                      | Min             | Typ         | Max  | Units           |
|-------------------------------------|--|--|-----------------|-------------|--|-----------------|
| <b>Frequency Domain Performance</b> |  |  |                 |             |  |                 |
| SSBW                                | -3 dB Bandwidth                                | $V_{OUT} = 0.5V_{PP}$                    |                 | 500         |  | MHz             |
| LSBW                                | -3 dB Bandwidth                                | $V_{OUT} = 2V_{PP}$                      |                 | 400         |  | MHz             |
| .1 dBBW                             | 0.1 dB Bandwidth                               | $V_{OUT} = 0.25V_{PP}$                   |                 | 150         |  | MHz             |
| DG                                  | Differential Gain                              | $R_L = 150\Omega$ , $f = 4.43$ MHz       |                 | 0.02        |  | %               |
| DP                                  | Differential Phase                             | $R_L = 150\Omega$ , $f = 4.43$ MHz       |                 | 0.05        |  | deg             |
| XTLK                                | Channel to Channel Crosstalk                   | All Hostile, 5MHz                        |                 | -85         |  | dB              |
| <b>Time Domain Response</b>         |  |  |                 |             |  |                 |
| TRS                                 | Channel to Channel Switching Time              | Logic transition to 90% output           |                 | 8           |  | ns              |
|                                     | Enable and Disable Times                       | Logic transition to 90% or 10% output.   |                 | 10          |  | ns              |
| TRL                                 | Rise and Fall Time                             | 4V Step                                  |                 | 2.4         |  | ns              |
| TSS                                 | Settling Time to 0.05%                         | 2V Step                                  |                 | 17          |  | ns              |
| OS                                  | Overshoot                                      | 2V Step                                  |                 | 5           |  | %               |
| SR                                  | Slew Rate                                      | 4V Step                                  |                 | 2200        |  | V/ $\mu$ s      |
| <b>Distortion</b>                   |  |  |                 |             |  |                 |
| HD2                                 | 2 <sup>nd</sup> Harmonic Distortion            | $2V_{PP}$ , 5 MHz                        |                 | -68         |  | dBc             |
| HD3                                 | 3 <sup>rd</sup> Harmonic Distortion            | $2V_{PP}$ , 5 MHz                        |                 | -84         |  | dBc             |
| IMD                                 | 3 <sup>rd</sup> Order Intermodulation Products | 10MHz, Two tones $2V_{pp}$ at output     |                 | -80         |  | dBc             |
| <b>Equivalent Input Noise</b>       |  |  |                 |             |  |                 |
| VN                                  | Voltage  | >1MHz, Input Referred                    |                 | 5           |  | nV $\sqrt{Hz}$  |
| ICN                                 | Current  | >1MHz, Input Referred                    |                 | 5           |  | pA/ $\sqrt{Hz}$ |
| <b>Static, DC Performance</b>       |  |  |                 |             |  |                 |
| CHGM                                | Channel to Channel Gain Difference             | DC, Difference in gain between channels  |                 | $\pm 0.005$ | $\pm 0.032$<br><b><math>\pm 0.035</math></b> | %               |
| VIO                                 | Input Offset Voltage (Note 5)                  | $V_{IN} = 0V$                            |                 | 1           | $\pm 20$<br><b><math>\pm 25</math></b>       | mV              |
| DVIO                                | Offset Voltage Drift                           |  |                 | 30          |  | $\mu$ V/°C      |
| IBN                                 | Input Bias Current (Notes 7, 5)                | $V_{IN} = 0V$                            |                 | -3          | $\pm 5$<br><b><math>\pm 5.6</math></b>       | $\mu$ A         |
| DIBN                                | Bias Current Drift                             |  |                 | 11          |  | nA/°C           |
|                                     | Inverting Input Bias Current                   | Pin 12, Feedback point,<br>$V_{IN} = 0V$ |                 | -7          | $\pm 10$<br><b><math>\pm 13</math></b>       |                 |
| PSRR                                | Power Supply Rejection Ratio (Note 5)          | DC, Input referred                       | 47<br><b>45</b> | 54          |  | dB              |

**±5V Electrical Characteristics** (Continued)

$V_S = \pm 5V$ ,  $R_L = 100\Omega$ ,  $A_V = 2 V/V$ ,  $T_J = 25^\circ C$ , Unless otherwise specified. **Bold** numbers specify limits at temperature extremes.

| Symbol                           | Parameter                             | Conditions (Note 2)  | Min  | Typ       | Max               | Units      |
|----------------------------------|---------------------------------------|--|--|-----------|-------------------|------------|
| ICC                              | Supply Current (Note 5)               | No Load  |  | 13        | 16<br><b>18</b>   | mA         |
|                                  | Supply Current Disabled (Note 5)      | $\overline{ENABLE} > 2V$   |  | 4.7       | 5.8<br><b>5.9</b> | mA         |
|                                  | Supply Current Shutdown               | SHUTDOWN > 2V  |  | 1.8       | 2.5<br><b>2.6</b> | mA         |
| VIH                              | Logic High Threshold (Note 5)         | Select & Enable Pins (SD & $\overline{EN}$ )                     | 2.0  |           |                   | V          |
| VIL                              | Logic Low Threshold (Note 5)          | Select & Enable Pins (SD & $\overline{EN}$ )                     |  |           | 0.8               | V          |
| liL                              | Logic Pin Input Current Low (Note 7)  | Logic Input = 0V Select & Enable Pins (SD & $\overline{EN}$ )    | -2.9<br><b>-8.5</b>                        | -1        |                   | $\mu A$    |
| liH                              | Logic Pin Input Current High (Note 7) | Logic Input = 2.0V, Select & Enable Pins (SD & $\overline{EN}$ ) |  | 47        | 68<br><b>72.5</b> | $\mu A$    |
| <b>Miscellaneous Performance</b> |                                       |  |  |           |                   |            |
| RIN+                             | Input Resistance                      |  |  | 5         |                   | k $\Omega$ |
| CIN                              | Input Capacitance                     |  |  | 0.8       |                   | pF         |
| ROUT                             | Output Resistance                     | Output Active, ( $\overline{EN}$ and SD < 0.8 V)                 |  | 0.04      |                   | $\Omega$   |
| ROUT                             | Output Resistance                     | Output Disabled, ( $\overline{EN}$ or SD > 2V)                   |  | 3000      |                   | $\Omega$   |
| COUT                             | Output Capacitance                    | Output Disabled, ( $\overline{EN}$ or SD > 2V)                   |  | 3.1       |                   | pF         |
| VO                               | Output Voltage Range                  | No Load  | $\pm 3.54$<br><b><math>\pm 3.53</math></b> | $\pm 3.7$ |                   | V          |
| VOL                              |                                       | $R_L = 100\Omega$  | $\pm 3.18$<br><b><math>\pm 3.17</math></b> | $\pm 3.5$ |                   | V          |
| CMIR                             | Input Voltage Range                   |  | $\pm 2.5$                                  | $\pm 2.6$ |                   | V          |
| IO                               | Linear Output Current (Notes 5, 7)    | $V_{IN} = 0V$ ,  | +60<br>-70<br><b>+50</b><br><b>-60</b>     | $\pm 80$  |                   | mA         |
| ISC                              | Short Circuit Current (Note 3)        | $V_{IN} = \pm 2V$ , Output shorted to ground                     |  | $\pm 230$ |                   | mA         |

**±3.3V Electrical Characteristics**

$V_S = \pm 3.3V$ ,  $R_L = 100\Omega$ ,  $A_V = 2 V/V$ ; Unless otherwise specified.

| Symbol                              | Parameter                           | Conditions (Note 2)   | Min | Typ  | Max | Units      |
|-------------------------------------|-------------------------------------|-----------------------|-----|------|-----|------------|
| <b>Frequency Domain Performance</b> |                                     |                       |     |      |     |            |
| SSBW                                | -3 dB Bandwidth                     | $V_{OUT} = 0.5V_{PP}$ |     | 475  |     | MHz        |
| LSBW                                | -3 dB Bandwidth                     | $V_{OUT} = 2.0V_{PP}$ |     | 375  |     | MHz        |
| 0.1 dBBW                            | 0.1 dB Bandwidth                    | $V_{OUT} = 0.5V_{PP}$ |     | 100  |     | MHz        |
| GFP                                 | Peaking                             | DC to 200MHz          |     | 0.4  |     | dB         |
| XTLK                                | Channel to Channel Crosstalk        | All Hostile, f=5MHz   |     | -85  |     | dBc        |
| <b>Time Domain Response</b>         |                                     |                       |     |      |     |            |
| TRL                                 | Rise and Fall Time                  | 2V Step               |     | 2    |     | ns         |
| TSS                                 | Settling Time to 0.05%              | 2V Step               |     | 20   |     | ns         |
| OS                                  | Overshoot                           | 2V Step               |     | 5    |     | %          |
| SR                                  | Slew Rate                           | 2V Step               |     | 1400 |     | V/ $\mu s$ |
| <b>Distortion</b>                   |                                     |                       |     |      |     |            |
| HD2                                 | 2 <sup>nd</sup> Harmonic Distortion | 2 $V_{PP}$ , 10MHz    |     | -67  |     | dBc        |
| HD3                                 | 3 <sup>rd</sup> Harmonic Distortion | 2 $V_{PP}$ , 10MHz    |     | -87  |     | dBc        |
| <b>Static, DC Performance</b>       |                                     |                       |     |      |     |            |
| VIO                                 | Input Offset Voltage                | $V_{IN} = 0V$         |     | -5   |     | mV         |

**±3.3V Electrical Characteristics** (Continued)

$V_S = \pm 3.3V$ ,  $R_L = 100\Omega$ ,  $A_V = 2$  V/V; Unless otherwise specified.

| Symbol                           | Parameter                    | Conditions (Note 2)                          | Min | Typ       | Max | Units      |
|----------------------------------|------------------------------|--|-----|-----------|-----|------------|
| IBN                              | Input Bias Current (Note 7)  | $V_{IN} = 0V$                                |     | -3        |     | $\mu A$    |
| PSRR                             | Power Supply Rejection Ratio | DC, Input Referred                           |     | 49        |     | dB         |
| ICC                              | Supply Current               | No Load                                      |     | 12        |     | mA         |
| VIH                              | Logic High Threshold         | Select & Enable Pins (SD & $\overline{EN}$ ) | 1.3 |           |     | V          |
| VIL                              | Logic Low Threshold          | Select & Enable Pins (SD & $\overline{EN}$ ) |     |           | 0.4 | V          |
| <b>Miscellaneous Performance</b> |                              |  |     |           |     |            |
| RIN+                             | Input Resistance             |  |     | 5         |     | k $\Omega$ |
| CIN                              | Input Capacitance            |  |     | 0.8       |     | pF         |
| ROUT                             | Output Resistance            |  |     | 0.06      |     | $\Omega$   |
| VO                               | Output Voltage Range         | No Load                                      |     | $\pm 2$   |     | V          |
| VOL                              |                              | $R_L = 100\Omega$                            |     | $\pm 1.8$ |     | V          |
| CMIR                             | Input Voltage Range          |  |     | $\pm 1.2$ |     | V          |
| IO                               | Linear Output Current        | $V_{IN} = 0V$                                |     | $\pm 60$  |     | mA         |
| ISC                              | Short Circuit Current        | $V_{IN} = \pm 1V$ , Output shorted to ground |     | $\pm 150$ |     | mA         |

**Note 1:** Absolute Maximum Ratings indicate limits beyond which damage to the device may occur. Operating Ratings indicate conditions for which the device is intended to be functional, but specific performance is not guaranteed. For guaranteed specifications, see the Electrical Characteristics tables.

**Note 2:** Electrical Table values apply only for factory testing conditions at the temperature indicated. Factory testing conditions result in very limited self-heating of the device such that  $T_J = T_A$ . No guarantee of parametric performance is indicated in the electrical tables under conditions of internal self heating where  $T_J > T_A$ . See Applications Section for information on temperature de-rating of this device. Min/Max ratings are based on product testing, characterization and simulation. Individual parameters are tested as noted.

**Note 3:** The maximum output current ( $I_{OUT}$ ) is determined by the device power dissipation limitations (The junction temperature cannot be allowed to exceed 150°C). See the Power Dissipation section of the Application Section for more details. A short circuit condition should be limited to 5 seconds or less.

**Note 4:** Human Body model, 1.5k $\Omega$  in series with 100pF. Machine model, 0 $\Omega$  in series with 200pF

**Note 5:** Parameters guaranteed by electrical testing at 25°C.

**Note 6:** Parameters guaranteed by design.

**Note 7:** Positive Value is current into device.

**Typical Performance Characteristics**  $V_S = \pm 5V$ ,  $R_L = 100\Omega$ ,  $A_V=2$ ,  $R_F=R_G=575\Omega$ ; unless otherwise specified.

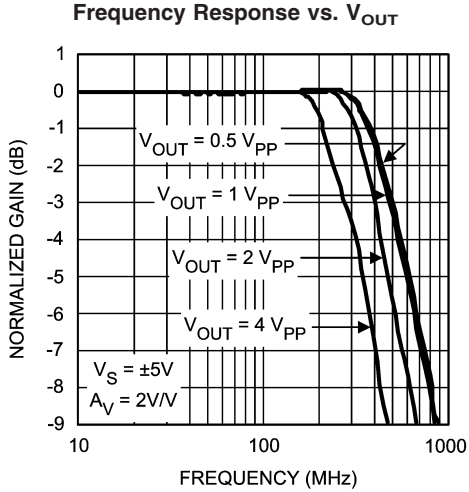

20119702

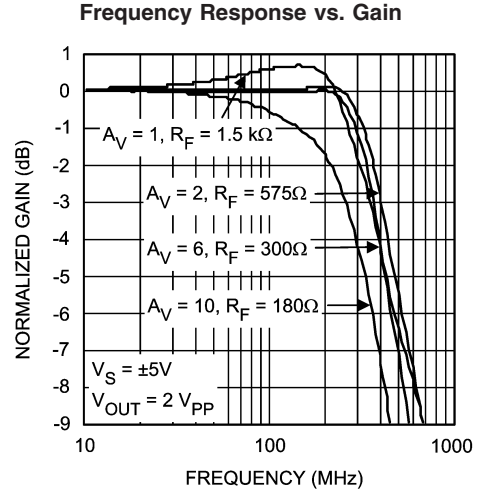

20119703

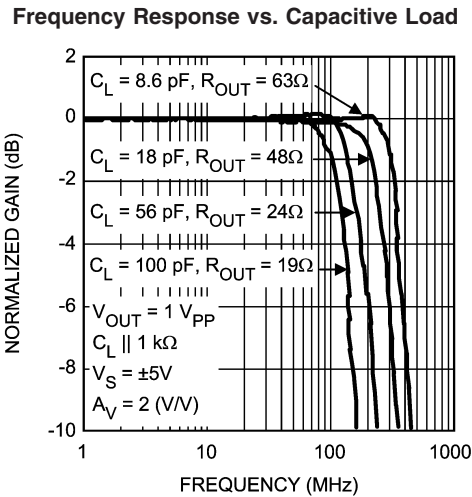

20119714

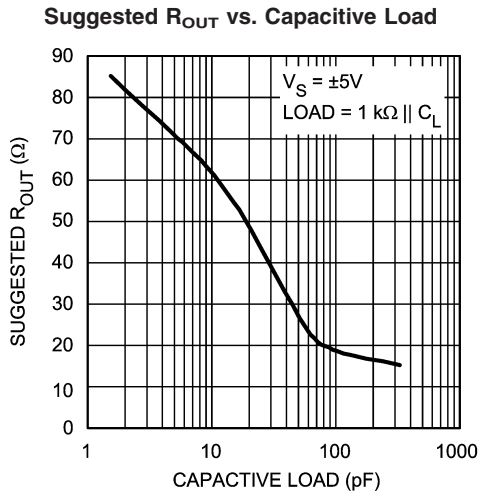

20119715

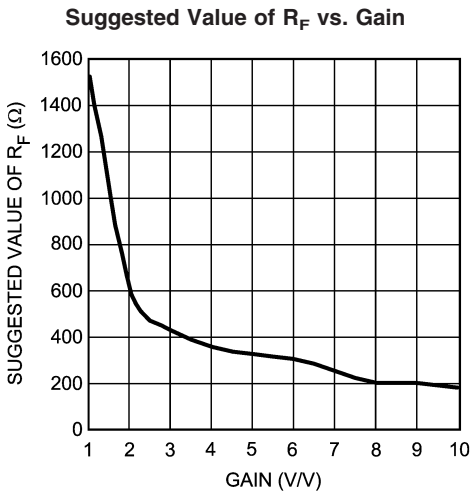

20119701

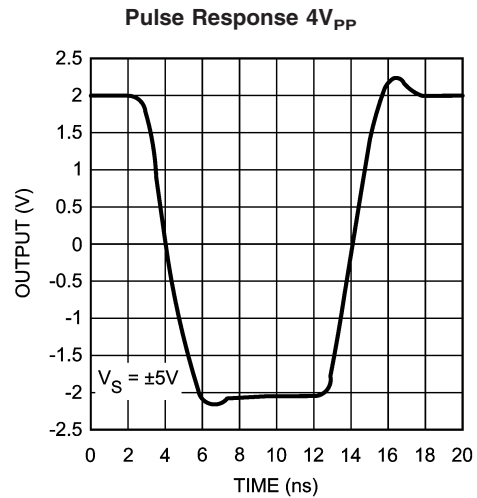

20119725

**Typical Performance Characteristics**  $V_S = \pm 5V$ ,  $R_L = 100\Omega$ ,  $A_V=2$ ,  $R_F=R_G=575\Omega$ ; unless otherwise specified. (Continued)

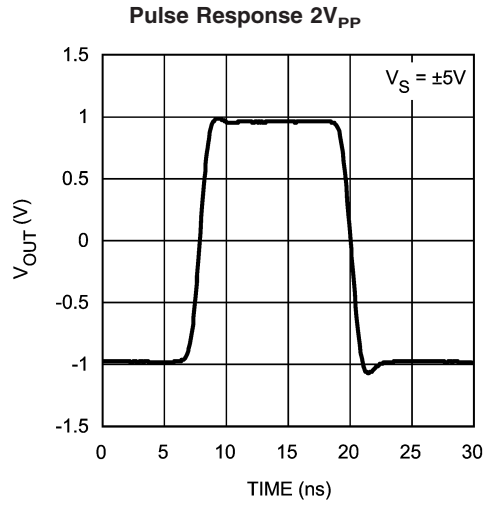

20119729

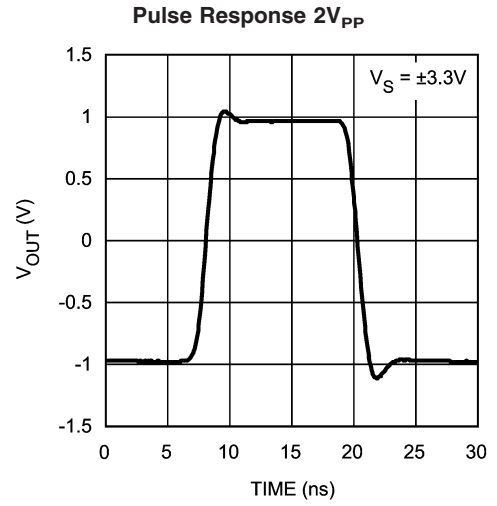

20119730

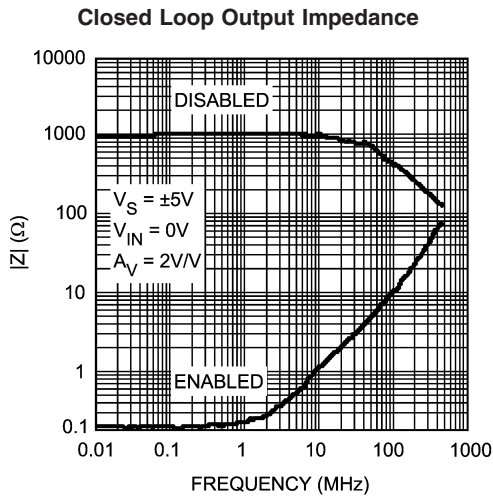

20119708

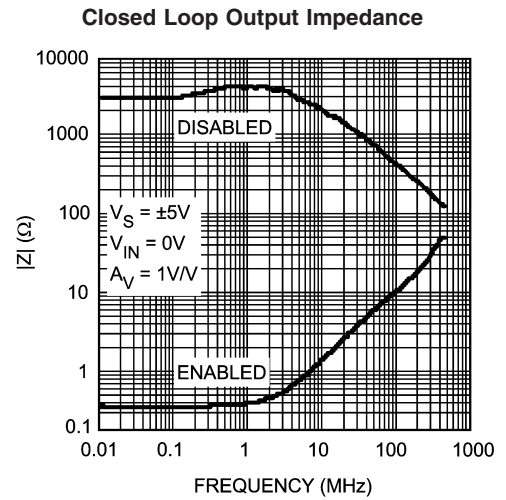

20119709

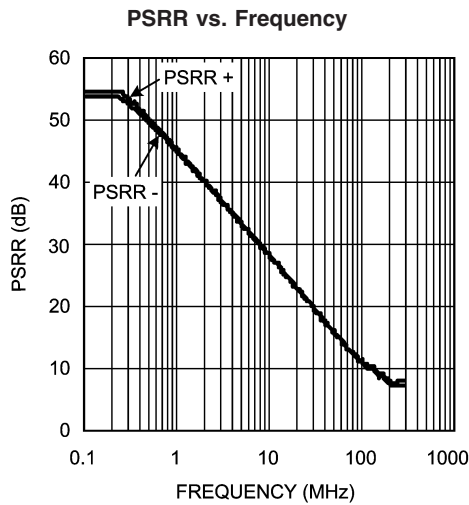

20119704

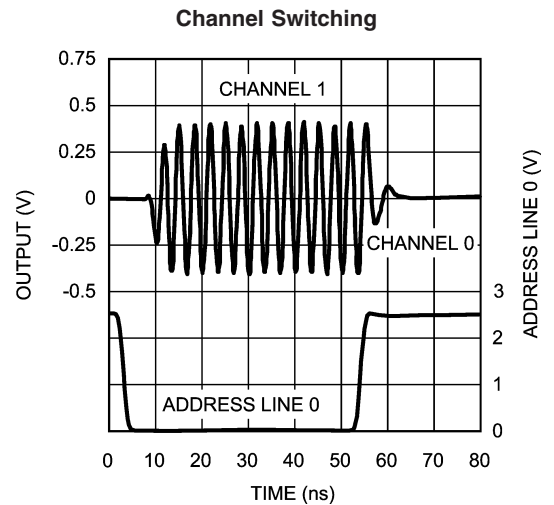

20119716

**Typical Performance Characteristics**  $V_s = \pm 5V$ ,  $R_L = 100\Omega$ ,  $A_V = 2$ ,  $R_F = R_G = 575\Omega$ ; unless otherwise specified. (Continued)

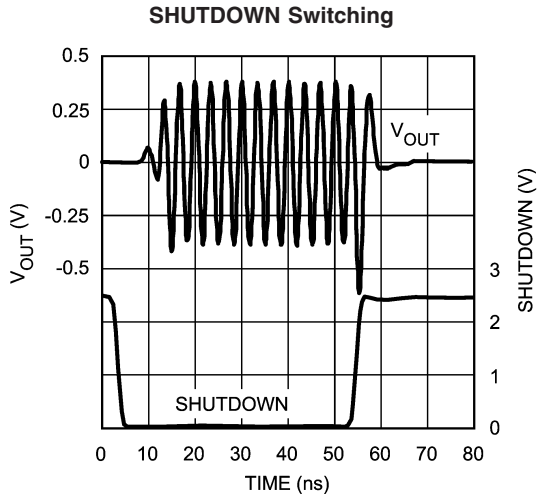

20119721

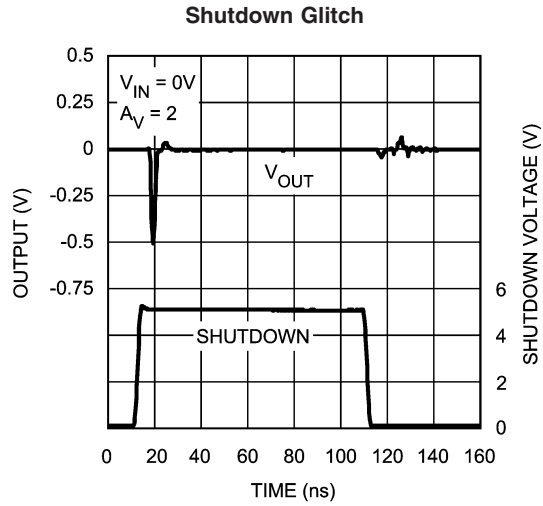

20119727

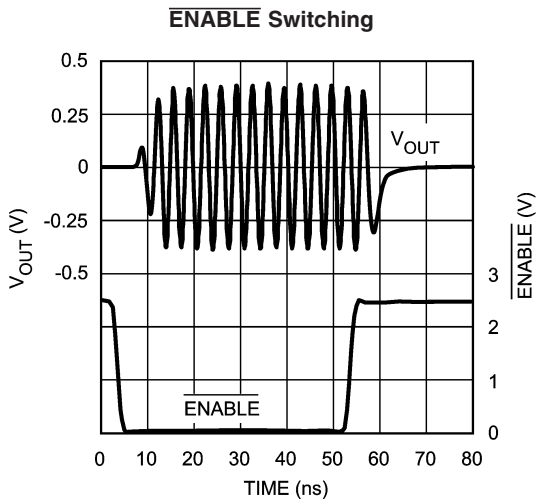

20119726

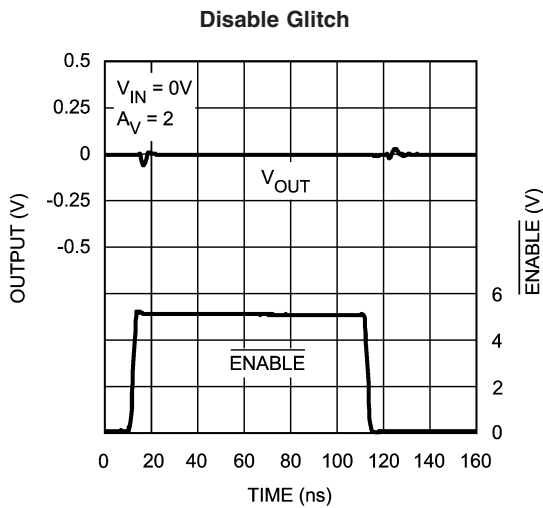

20119728

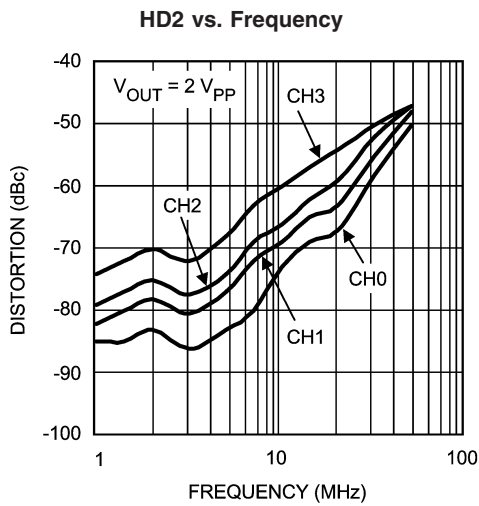

20119733

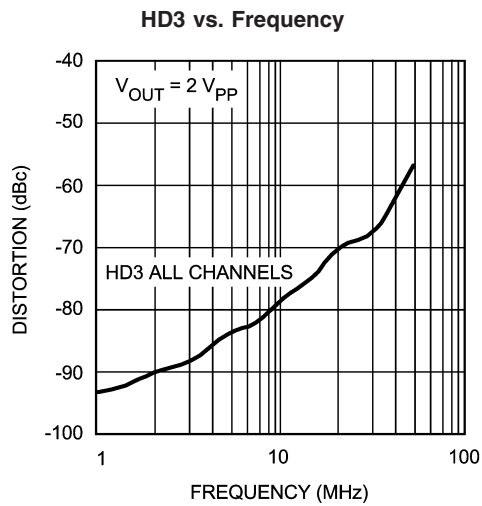

20119734

**Typical Performance Characteristics**  $V_s = \pm 5V$ ,  $R_L = 100\Omega$ ,  $A_V=2$ ,  $R_F=R_G=575\Omega$ ; unless otherwise specified. (Continued)

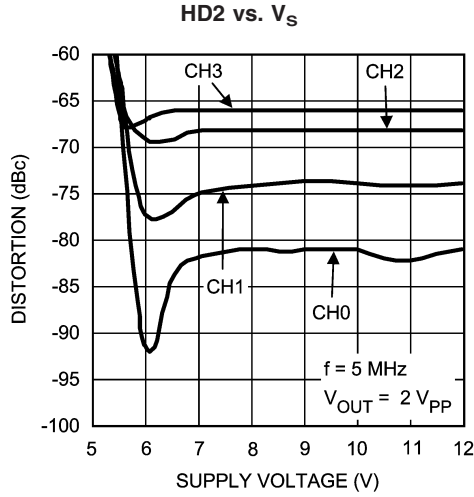

20119707

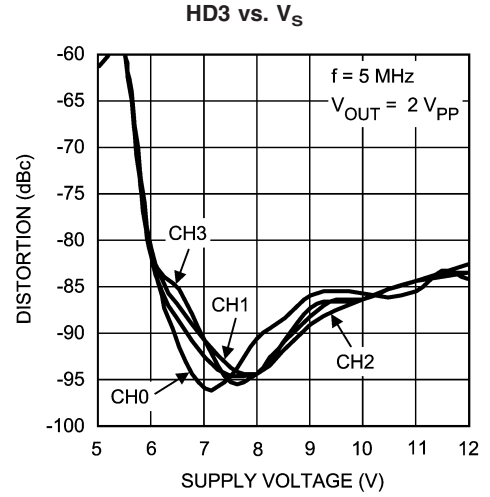

20119706

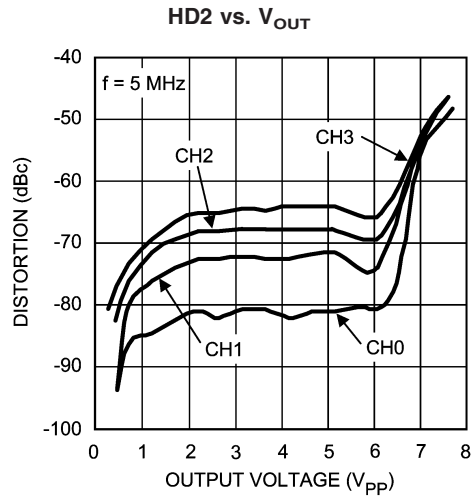

20119711

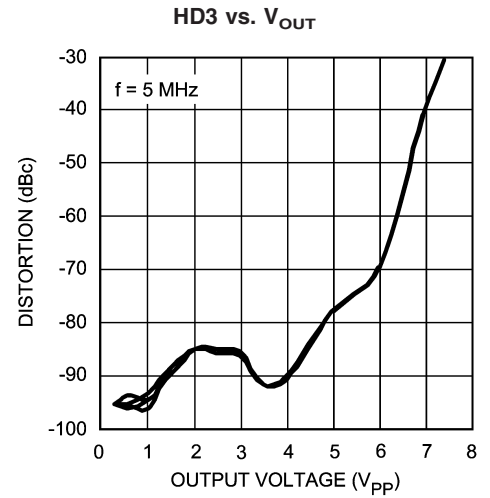

20119710

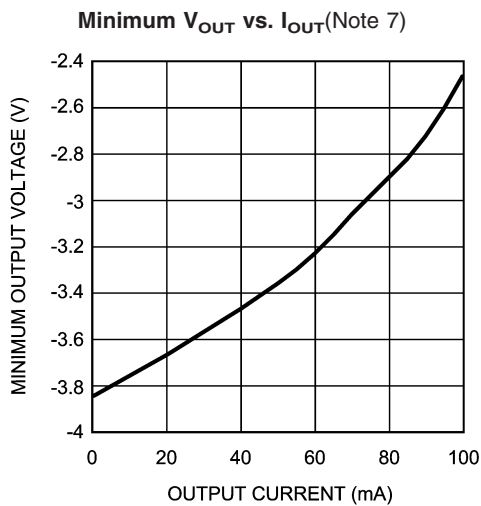

20119712

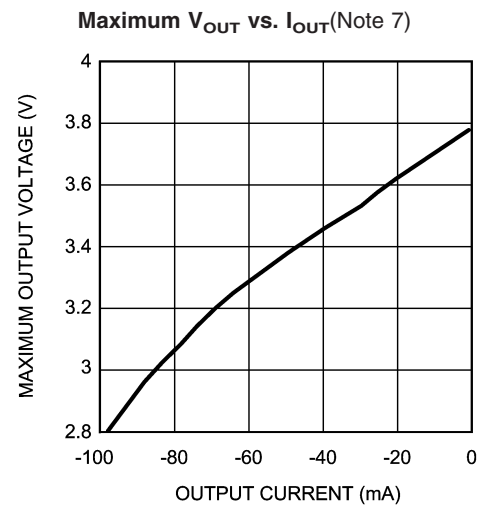

20119713



**Typical Performance Characteristics**  $V_S = \pm 5V$ ,  $R_L = 100\Omega$ ,  $A_V=2$ ,  $R_F=R_G=575\Omega$ ; unless otherwise specified. (Continued)

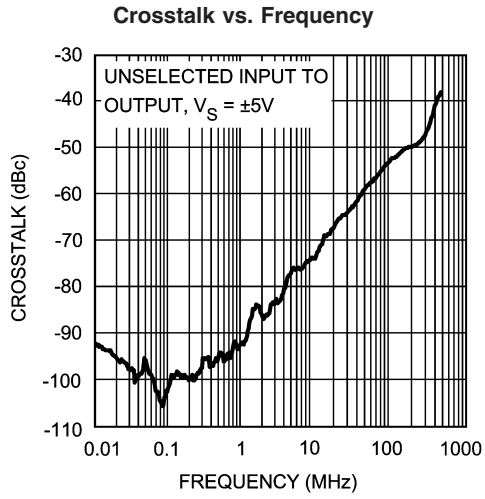

20119735

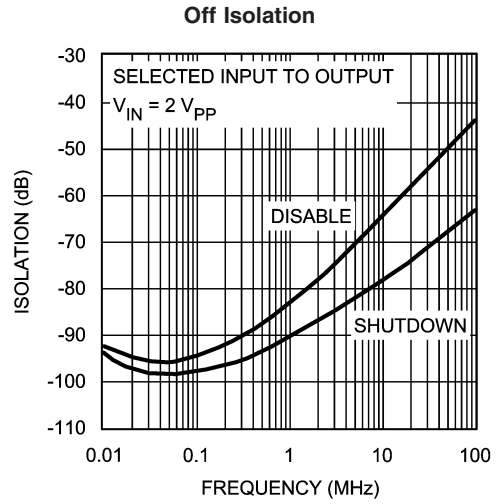

20119731

# Application Notes

## GENERAL INFORMATION

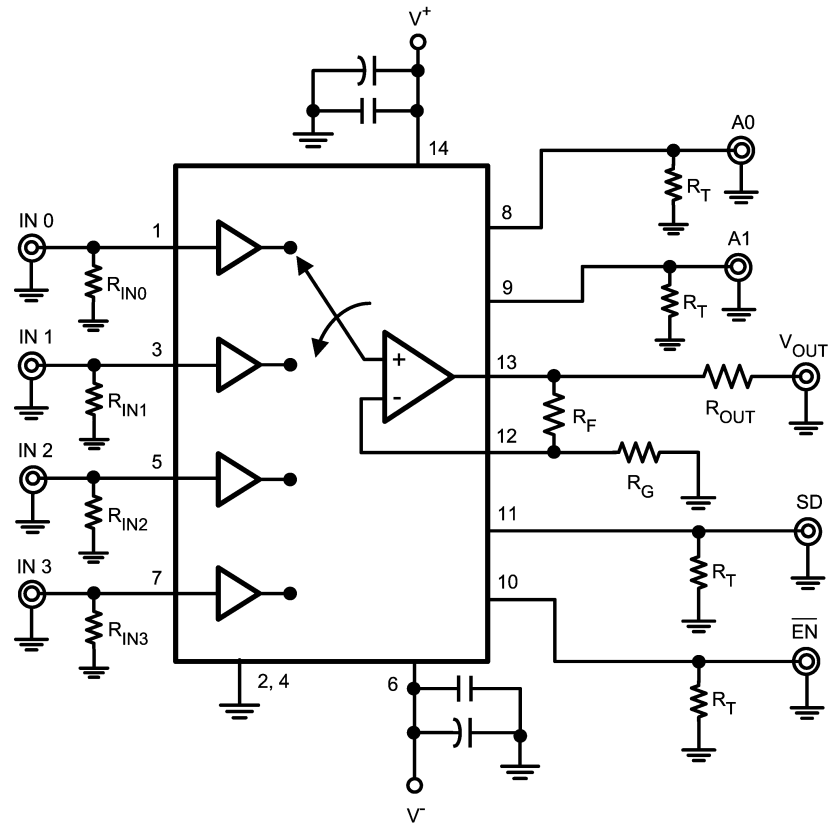

20119722

FIGURE 1. Typical Application

The LMH6574 is a high-speed 4:1 analog multiplexer, optimized for very high speed and low distortion. With selectable gain and excellent AC performance, the LMH6574 is ideally suited for switching high resolution, presentation grade video signals. The LMH6574 has no internal ground reference. Single or split supply configurations are both possible. The LMH6574 features very high speed channel switching and disable times. When disabled the LMH6574 output is high impedance making MUX expansion possible by combining multiple devices. See "Multiplexer Expansion" section below.

### VIDEO PERFORMANCE

The LMH6574 has been designed to provide excellent performance with production quality video signals in a wide variety of formats such as HDTV and High Resolution VGA. Best performance will be obtained with back-terminated loads. The back termination reduces reflections from the transmission line and effectively masks transmission line and other parasitic capacitances from the amplifier output stage. Figure 1 shows a typical configuration for driving a 75Ω Cable. The output buffer is configured for a gain of 2, so using back terminated loads will give a net gain of 1.

### FEEDBACK RESISTOR SELECTION

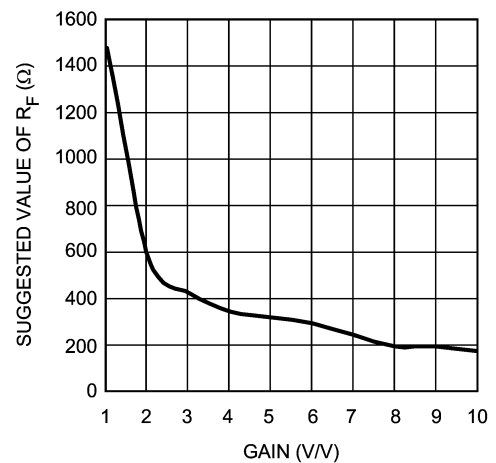

20119732

FIGURE 2. Suggested R<sub>F</sub> vs. Gain

The LMH6574 has a current feedback output buffer with gain determined by external feedback (R<sub>F</sub>) and gain set (R<sub>G</sub>) resistors. With current feedback amplifiers, the closed loop

## Application Notes (Continued)

frequency response is a function of  $R_F$ . For a gain of 2 V/V, the recommended value of  $R_F$  is 575 $\Omega$ . For other gains see the chart "Suggested  $R_F$  vs Gain". Generally, lowering  $R_F$  from the recommended value will peak the frequency response and extend the bandwidth while increasing the value of  $R_F$  will cause the frequency response to roll off faster. Reducing the value of  $R_F$  too far below the recommended value will cause overshoot, ringing and, eventually, oscillation.

Since all applications are slightly different it is worth some experimentation to find the optimal  $R_F$  for a given circuit. For more information see Application Note OA-13 which describes the relationship between  $R_F$  and closed-loop frequency response for current feedback operational amplifiers. The impedance looking into pin 12 is approximately 20 $\Omega$ . This allows for good bandwidth at gains up to 10 V/V. When used with gains over 10 V/V, the LMH6574 will exhibit a "gain bandwidth product" similar to a typical voltage feedback amplifier. For gains of over 10 V/V consider selecting a high performance video amplifier like the LMH6720 to provide additional gain.

### SD vs. $\overline{EN}$

The LMH6574 has both shutdown and disable capability. The shutdown feature affects the entire chip, whereas the disable function only affects the output buffer. When in shutdown mode, minimal power is consumed. The shutdown function is very fast, but causes a very brief spike of about 400 mV to appear on the output. When in shutdown mode the LMH6574 consumes only 1.8 mA of supply current. For maximum input to output isolation use the shutdown function.

The  $\overline{EN}$  pin only disables the output buffer which results in a substantially reduced output glitch of only 50 mV. While disabled the chip consumes 4.7 mA, considerably more than when shutdown. This is because the input buffers are still active. For minimal output glitch use the  $\overline{EN}$  pin. Also, care should be taken to ensure that, while in the disabled state, the voltage differential between the active input buffer (the one selected by pins A0 and A1) and the output pin stays less than 2V. As the voltage differential increases, input to output isolation decreases. Normally this is not an issue. See the section on MULTIPLEXER EXPANSION for further details.

To reduce the output glitch when using the SD pin, switch the  $\overline{EN}$  pin at least 10 ns before switching the SD pin. This can be accomplished by using an RC delay circuit between the two pins if only one control signal is available.

### EVALUATION BOARDS

National Semiconductor provides the following evaluation boards as a guide for high frequency layout and as an aid in device testing and characterization. Many of the data sheet plots were measured with this board.

| Device  | Package | Evaluation Board |
|---------|---------|------------------|
| LMH6574 | SOIC    | LMH730276        |

An evaluation board can be shipped when a sample request is placed with National Semiconductor. Samples can be ordered on the National web page. ([www.national.com](http://www.national.com))

### MULTIPLEXER EXPANSION

With the SHUTDOWN pin putting the output stage into a high impedance state, several LMH6574's can be tied together to form a larger input MUX. However, there is a loading effect on the active output caused by the unselected devices. The circuit in *Figure 3* shows how to compensate for this effect. For the 16:1 MUX function shown in *Figure 3* below the gain error would be about -0.8 dB, or about 9%. In the circuit in *Figure 3*, resistor ratios have been adjusted to compensate for this gain error. By adjusting the gain of each multiplexer circuit the error can be reduced to the tolerance of the resistors used (1% in this example).

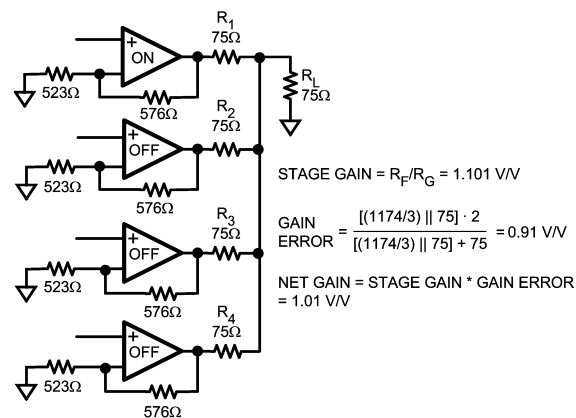

20119717

FIGURE 3. Multiplexer Gain Compensation

Disabling of the LMH6574 using the  $\overline{EN}$  pin is not recommended for use when doing multiplexer expansion. While disabled, if the voltage between the selected input and the chip output exceeds approximately 2V the device will begin to enter a soft breakdown state. This will show up as reduced input to output isolation. The signal on the non-inverting input of the output driver amplifier will leak through to the inverting input, and then to the output through the feedback resistor. The worst case is a gain of 1 configuration where the non inverting input follows the active input buffer and (through the feedback resistor) the inverting input follows the voltage driving the output stage. The solution for this is to use shutdown mode for multiplexer expansion.

### BUILDING an 8:1 MULTIPLEXER

*Figure 4* shows an 8:1 MUX using two LMH6574's.

Application Notes (Continued)

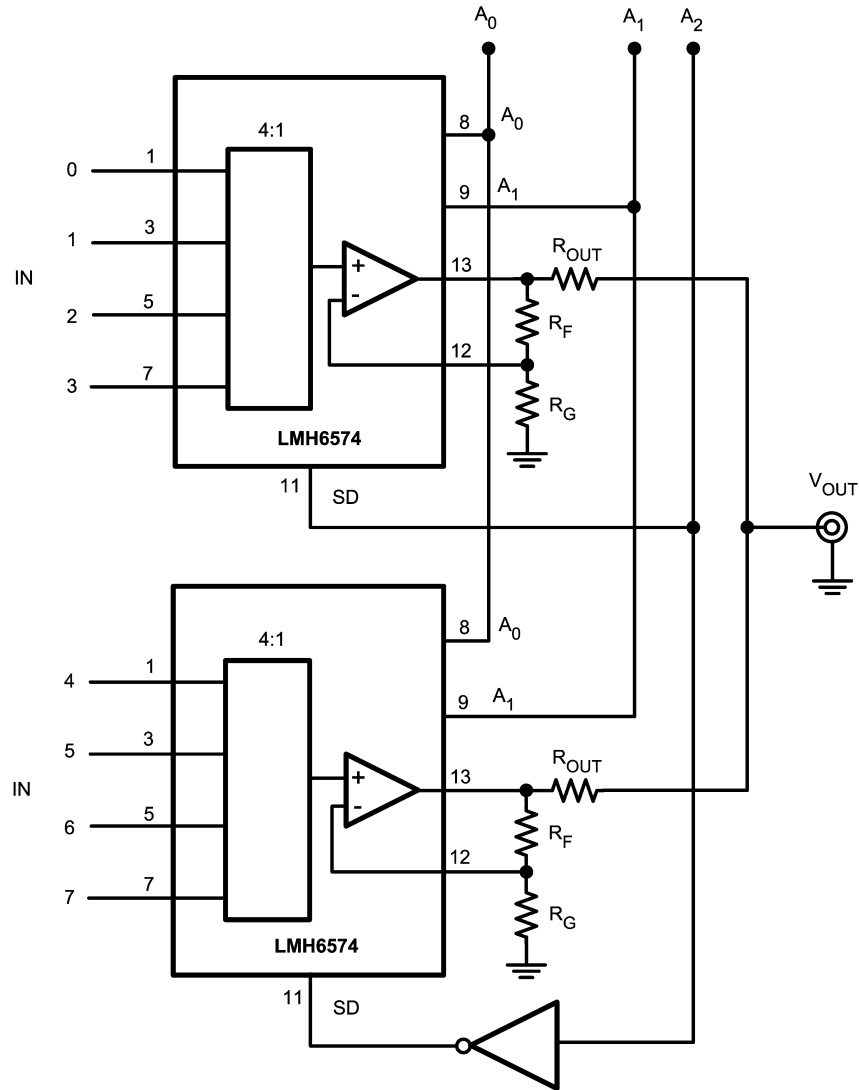

20119718

FIGURE 4. 8:1 MUX USING TWO LMH6574's

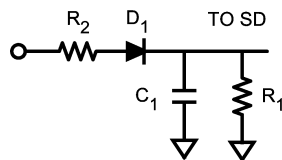

20119719

FIGURE 5. Delay Circuit Implementation

If it is important in the end application to make sure that no two inputs are presented to the output at the same time, an optional delay block can be added, to drive the SHUTDOWN pin of each device, as shown. Figure 5 shows one possible approach to this delay circuit. The delay circuit shown will delay SHUTDOWN's H to L transitions ( $R_1$  and  $C_1$  decay)

but won't delay its L to H transition.  $R_2$  should be kept small compared to  $R_1$  in order to not reduce the SHUTDOWN voltage and to produce little or no delay to SHUTDOWN.

Other Applications

The LMH6574 could support a multi antenna receiver with up to four separate antennas. Monitoring the signal strength of all 4 antennas and connecting the strongest signal to the final IF stage would provide effective spacial diversity.

For direction finding, the LMH6574 could be used to provide high speed sampling of four separate antennas to a single DSP which would use the information to calculate the direction of the received signal.

DRIVING CAPACITIVE LOADS

Capacitive output loading applications will benefit from the use of a series output resistor  $R_{OUT}$ . Figure 6 shows the use of a series output resistor,  $R_{OUT}$ , to stabilize the amplifier

## Other Applications (Continued)

output under capacitive loading. Capacitive loads of 5 to 120 pF are the most critical, causing ringing, frequency response peaking and possible oscillation. The chart "Suggested  $R_{OUT}$  vs. Cap Load" gives a recommended value for selecting a series output resistor for mitigating capacitive loads. The values suggested in the charts are selected for 0.5 dB or less of peaking in the frequency response. This gives a good compromise between settling time and bandwidth. For applications where maximum frequency response is needed and some peaking is tolerable, the value of  $R_{OUT}$  can be reduced slightly from the recommended values.

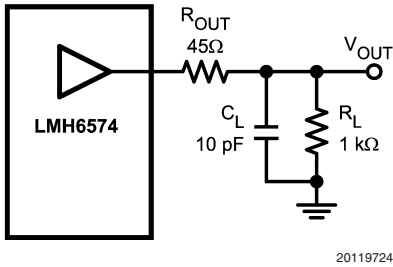

20119724

FIGURE 6. Decoupling Capacitive Loads

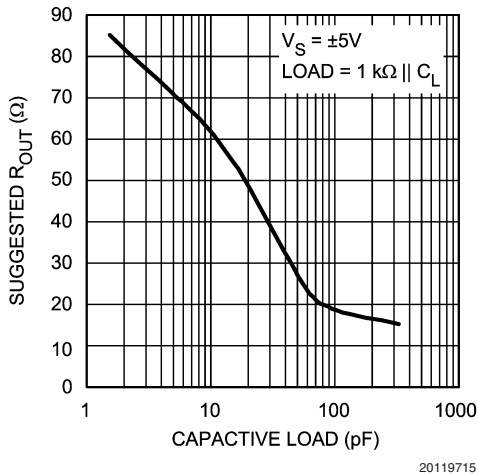

20119715

FIGURE 7. Suggested  $R_{OUT}$  vs. Capacitive Load

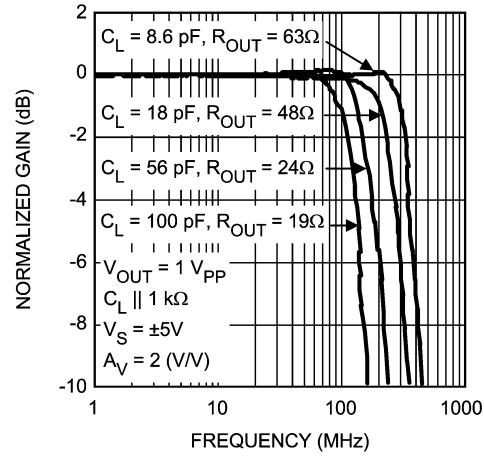

20119714

FIGURE 8. Frequency Response vs. Capacitive Load

### LAYOUT CONSIDERATIONS

Whenever questions about layout arise, use the evaluation board as a guide. The LMH730276 is the evaluation board supplied with samples of the LMH6574. To reduce parasitic capacitances, ground and power planes should be removed near the input and output pins. For long signal paths controlled impedance lines should be used, along with impedance matching elements at both ends. Bypass capacitors should be placed as close to the device as possible. Bypass capacitors from each rail to ground are applied in pairs. The larger electrolytic bypass capacitors can be located farther from the device, the smaller ceramic capacitors should be placed as close to the device as possible. In Figure 1, the capacitor between  $V^+$  and  $V^-$  is optional, but is recommended for best second harmonic distortion. Another way to enhance performance is to use pairs of 0.01  $\mu F$  and 0.1  $\mu F$  ceramic capacitors for each supply bypass.

### POWER DISSIPATION

The LMH6574 is optimized for maximum speed and performance in the small form factor of the standard SOIC package. To ensure maximum output drive and highest performance, thermal shutdown is not provided. Therefore, it is of utmost importance to make sure that the  $T_{JMAX}$  is never exceeded due to the overall power dissipation.

Follow these steps to determine the Maximum power dissipation for the LMH6574:

1. Calculate the quiescent (no-load) power:  $P_{AMP} = I_{CC} * (V_S)$ , where  $V_S = V^+ - V^-$ .
2. Calculate the RMS power dissipated in the output stage:  $P_D (rms) = rms ((V_S - V_{OUT}) * I_{OUT})$ , where  $V_{OUT}$  and  $I_{OUT}$  are the voltage across and the current through the external load and  $V_S$  is the total supply voltage.
3. Calculate the total RMS power:  $P_T = P_{AMP} + P_D$ .

The maximum power that the LMH6574 package can dissipate at a given temperature can be derived with the following equation:

$P_{MAX} = (150^\circ - T_{AMB}) / \theta_{JA}$ , where  $T_{AMB}$  = Ambient temperature ( $^\circ C$ ) and  $\theta_{JA}$  = Thermal resistance, from junction to ambient, for a given package ( $^\circ C/W$ ). For the SOIC package  $\theta_{JA}$  is 130  $^\circ C/W$ .

## Other Applications (Continued)

### ESD PROTECTION

The LMH6574 is protected against electrostatic discharge (ESD) on all pins. The LMH6574 will survive 2000V Human Body model and 200V Machine model events. Under normal operation the ESD diodes have no effect on circuit performance. There are occasions, however, when the ESD di-

odes will be evident. If the LMH6574 is driven by a large signal while the device is powered down the ESD diodes will conduct. The current that flows through the ESD diodes will either exit the chip through the supply pins or will flow through the device, hence it is possible to power up a chip with a large signal applied to the input pins. Using the shutdown mode is one way to conserve power and still prevent unexpected operation.

**Physical Dimensions** inches (millimeters) unless otherwise noted

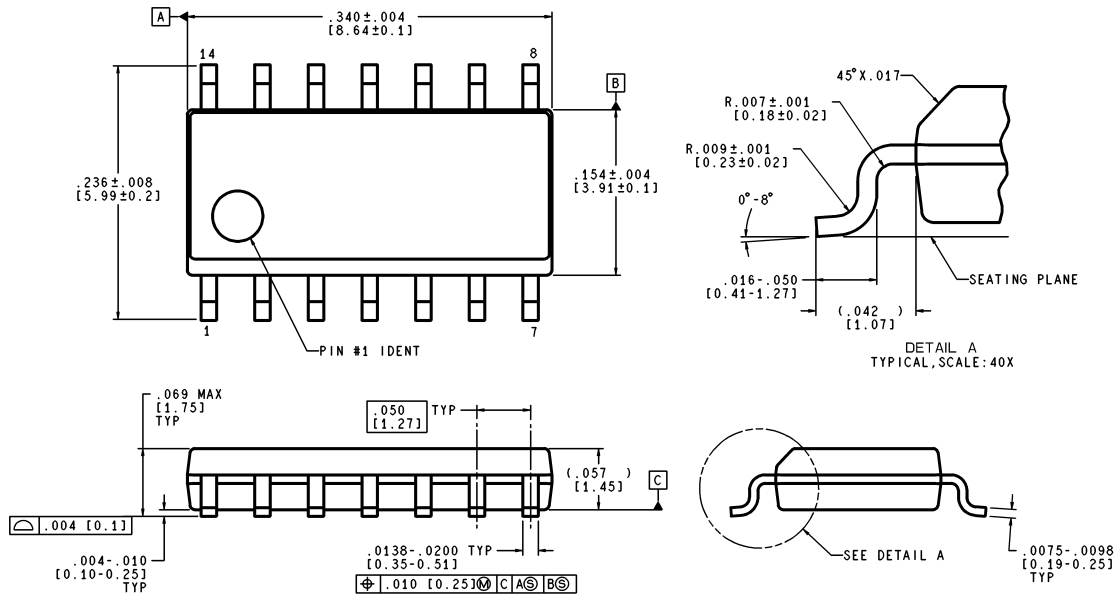

CONTROLLING DIMENSION IS INCH  
VALUES IN [ ] ARE MILLIMETERS

M14A (Rev J)

**14-Pin SOIC  
NS Package Number M14A**

National does not assume any responsibility for use of any circuitry described, no circuit patent licenses are implied and National reserves the right at any time without notice to change said circuitry and specifications.

For the most current product information visit us at [www.national.com](http://www.national.com).

**LIFE SUPPORT POLICY**

NATIONAL'S PRODUCTS ARE NOT AUTHORIZED FOR USE AS CRITICAL COMPONENTS IN LIFE SUPPORT DEVICES OR SYSTEMS WITHOUT THE EXPRESS WRITTEN APPROVAL OF THE PRESIDENT AND GENERAL COUNSEL OF NATIONAL SEMICONDUCTOR CORPORATION. As used herein:

1. Life support devices or systems are devices or systems which, (a) are intended for surgical implant into the body, or (b) support or sustain life, and whose failure to perform when properly used in accordance with instructions for use provided in the labeling, can be reasonably expected to result in a significant injury to the user.
2. A critical component is any component of a life support device or system whose failure to perform can be reasonably expected to cause the failure of the life support device or system, or to affect its safety or effectiveness.

**BANNED SUBSTANCE COMPLIANCE**

National Semiconductor certifies that the products and packing materials meet the provisions of the Customer Products Stewardship Specification (CSP-9-111C2) and the Banned Substances and Materials of Interest Specification (CSP-9-111S2) and contain no "Banned Substances" as defined in CSP-9-111S2.



**National Semiconductor**  
Americas Customer  
Support Center  
Email: [new.feedback@nsc.com](mailto:new.feedback@nsc.com)  
Tel: 1-800-272-9959

**National Semiconductor**  
Europe Customer Support Center  
Fax: +49 (0) 180-530 85 86  
Email: [europe.support@nsc.com](mailto:europe.support@nsc.com)  
Deutsch Tel: +49 (0) 69 9508 6208  
English Tel: +44 (0) 870 24 0 2171  
Français Tel: +33 (0) 1 41 91 8790

**National Semiconductor**  
Asia Pacific Customer  
Support Center  
Email: [ap.support@nsc.com](mailto:ap.support@nsc.com)

**National Semiconductor**  
Japan Customer Support Center  
Fax: 81-3-5639-7507  
Email: [jpn.feedback@nsc.com](mailto:jpn.feedback@nsc.com)  
Tel: 81-3-5639-7560