

Through-beam, Reflective and Zone Models

- 1 m through-beam for long range applications
- Narrow beam angle of 8° detects objects as small as 2 x 2 cm
- Zone models detect objects smoothly while suppressing interference from background objects
- 200 kHz provides high immunity from environmental noise
- User-selectable normally open and normally closed operation



Ordering Information

| Supply voltage | Sensing type | Sensing distance | Cable length | Part number | | |
|----------------|------------------|------------------|--------------|----------------------|----------------------|----------------------|
| | | | | NPN output | PNP output | |
| 12 to 24 VDC | Through-beam | 1 m | 2 m | E4B-T1E4 2M | E4B-T1F4 2M | |
| | | | 5 m | E4B-T1E4 5M | E4B-T1F4 5M | |
| | | 50 cm | 2 m | E4B-TS50E4 2M | E4B-TS50F4 2M | |
| | | | 5 m | E4B-TS50E4 5M | E4B-TS50F4 5M | |
| | | Zone setting | 20 to 70 cm | 2 m | E4B-RS70E4 2M | E4B-RS70F4 2M |
| | | | | 5 m | E4B-RS70E4 5M | E4B-RS70F4 5M |
| | Distance setting | 20 to 70 cm | 2 m | E4B-LS70E4 2M | E4B-LS70F4 2M | |
| | | | 5 m | E4B-LS70E4 5M | E4B-LS70F4 5M | |
| | | 5 to 20 cm | 2 m | E4B-LS20E4 2M | E4B-LS20F4 2M | |
| | | | 5 m | E4B-LS20E4 5M | E4B-LS20F4 5M | |

■ SENSING TYPE

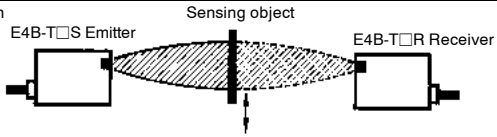
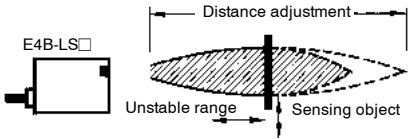
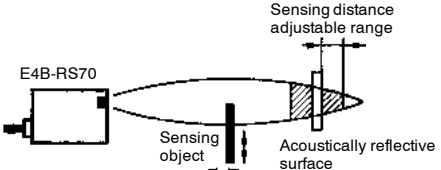
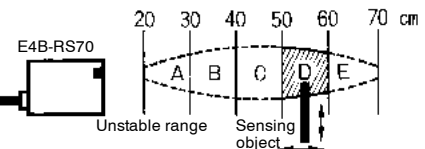
| | | | |
|--------------|------------------|--|--|
| Through-beam | | <p>Detects the attenuation or interrupted condition of the ultrasonic beam caused by the object passing between the Emitter and Receiver.</p>  | |
| Reflective | Setting distance | <p>Detects only the beam reflected from the object existing within the sensing distance range set with the distance adjuster.</p>  | |
| | Setting zone | Sensing background | <p>Detects the object with the interruption of the normal beam reflected from the acoustically reflective surface.</p>  |
| | | Sensing target | <p>Detects only the beam reflected from the object existing in the sensing range set with the distance selector.</p>  |

Note: An object may be detected due to multiple reflection if the object is in the unstable range where the distance adjuster is ineffective, in which case however, the detection of the object will not be stable. Therefore, do not attempt to use the E4B to detect an object in the unstable range.

Specifications

■ RATINGS/CHARACTERISTICS

| | | | | | |
|--|--|---|---|---|---|
| Part number | E4B-TS50E4 | E4B-T1E4 | E4B-LS20E4 | E4B-LS70E4 | E4B-RS70E4 |
| Sensing method | Through-beam | | Distance setting | | Zone setting |
| Supply voltage | 12 to 24 VDC \pm 10% (10.8 to 26.4 VDC) with a max. ripple \pm 10% (p-p) | | | | |
| Current consumption | 12 VDC | Emitter: 155 mA max. Receiver: 30 mA max. | Emitter: 70 mA max. Receiver: 30 mA max. | 100 mA max. | |
| | 24 VDC | Emitter: 80 mA max. Receiver: 30 mA max. | Emitter: 50 mA max. Receiver: 30 mA max. | 50 mA max. | |
| Sensing distance | 50 cm (19.69 in) | 1 m (3.28 ft) | 5 to 20 cm (1.97 to 7.87 in) | 20 to 60 cm (20 to 70 cm) (See Note 1.) (7.87 in to 23.62 in) | 20 to 60 cm (20 to 70 cm) (See Note 1.) (in 10-cm divisions) (7.87 to 23.62 in) |
| Standard sensing object | 10 x 10 cm flat plate | | 4 x 4 cm flat plate | | |
| Differential travel | — | | 20% max. of sensing distance | | 3 cm max. |
| Directional angle (See Note 2.) | \pm 8° max. | | | | |
| Ultrasonic oscillation frequency | 200 kHz | | | | |
| Switching frequency (See Note 3.) | 50 Hz | 10 Hz | 50 Hz | 20 Hz | |
| Response time | 10 ms | 50 ms | 10 ms | 25 ms | |
| Operating mode | N.O. or N.C. selectable | | | | |
| Control output | NPN | 100 mA at 30 VDC (with a residual voltage of 1.5 V max.) and an output resistance of 4.7 k Ω | | | |
| | PNP | | | | |
| Residual voltage | 1.5 V max. under a load current of 100 mA | | | | |
| Indicators | SENSING indicator (red LED) and STABILITY indicator (green LED) | | | | |
| Ultrasonic speed compensation | No | | | | Yes |
| Ambient operating temperature | -10°C to 55°C (14°F to 131°F) | | | | |
| Relative humidity | 35% to 95% | | | | |
| Temperature influence | \pm 10% max. of sensing distance at 20°C (68°F) in the temperature range of -10°C and 55°C (14°F to 131°F) | | | | |
| Voltage influence | \pm 5% max. of sensing distance at a voltage between 90% and 110% of the rated power supply voltage | | | | |
| Insulation resistance | 20 M Ω min. at 500 VDC between current carry parts and case | | | | |
| Dielectric strength | 1,000 V (50/60 Hz) for 1 min between current carry parts and case | | | | |
| Vibration resistance | 10 to 55 Hz, 1.5-mm double amplitude for 2 hours each in X, Y, and Z axes | | | | |
| Shock resistance | 500 m/s ² (approx. 50G) 3 times each in X, Y, and Z axes | | | | |
| Enclosure rating | IEC IP66 (water resistant) | | | | |
| Approvals | UL, cUL | Recognized, File No. E41515 when used with a Class 2 power source | | | |
| Weight (with 2-m-long cord and Mounting Bracket) | Approx. 600 g (21 oz) with Emitter and Receiver | | Approx. 300 g (10.6 oz) | | |

- Note: 1. These are the available sensing distances at an ambient temperature range between 0°C and 45°C (32°F to 113°F)
 2. Signal attenuation of -6 dB.
 3. The switching frequencies are values obtained with the E4B used for detecting a rotating propeller-shaped disc as shown below.

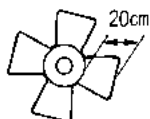

Space:Blade = 1:1

Operation

■ OUTPUT CIRCUITS

NPN Output DC

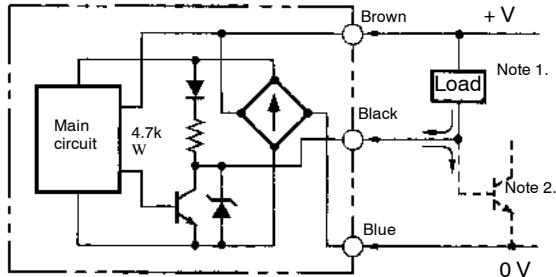

- Note: 1. 100 mA max. (load current)
 2. Required when the transistor circuit is connected.

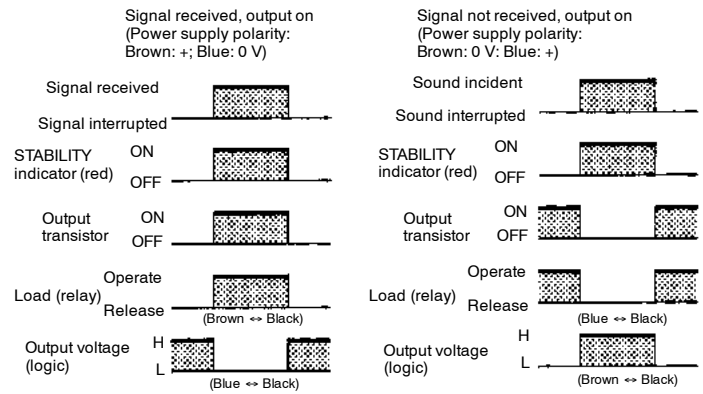

PNP Output

(No Diagram Provided)

Engineering Data

OPERATING DISTANCE VS. SENSING OBJECT SIZE (TYPICAL)

E4B-TS50E4, E4B-T1E4

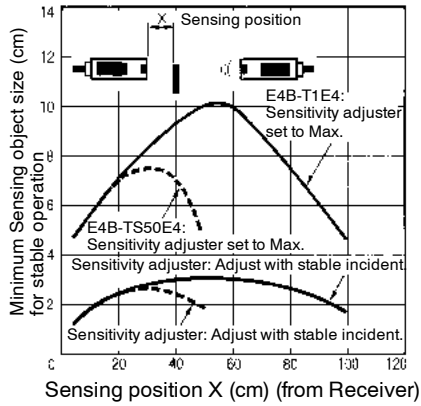

E4B-LS20E4

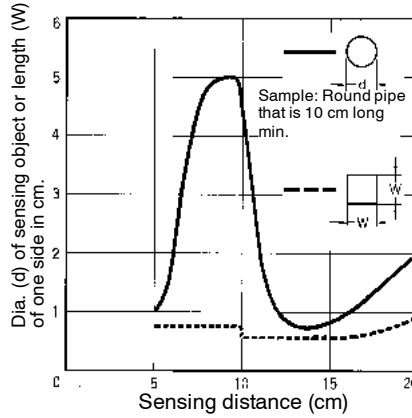

E4B-LS70E4, E4B-RS70E4

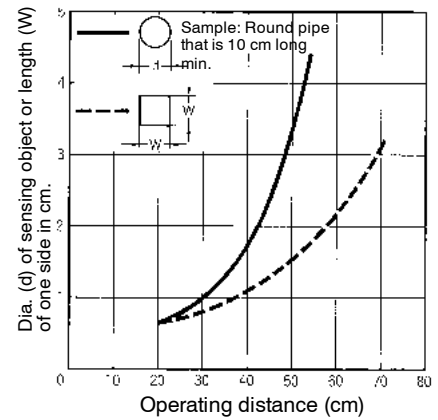

OPERATING RANGE DIAGRAM (TYPICAL)

E4B-LS20E4

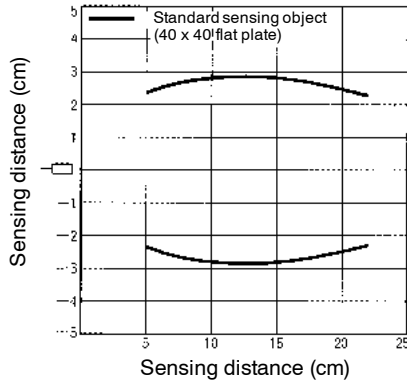

E4B-LS70E4, E4B-RS70E4

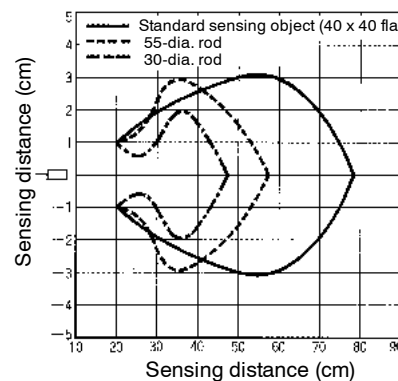

OPERATING DISTANCE VS. SENSING OBJECT ANGLE (TYPICAL)

E4B-LS70E4, E4B-RS70E4

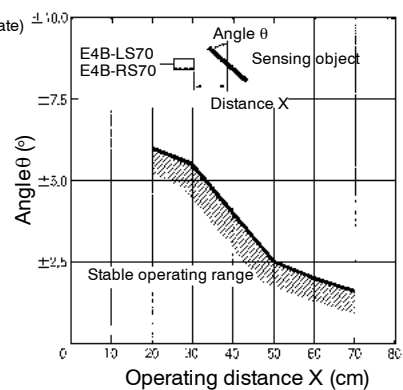

■ AMBIENT TEMPERATURE VS. VARIATION RATE OF SENSING DISTANCE (TYPICAL)

E4B-LS70E4, E4B-RS70E4

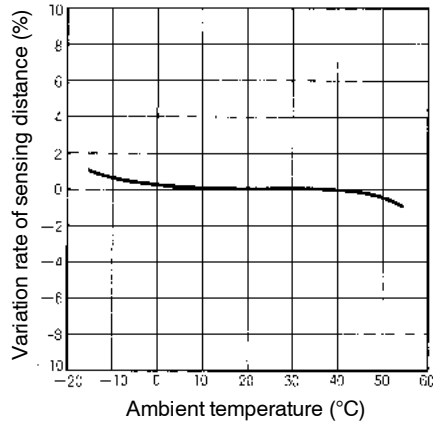

■ SENSITIVITY ADJUSTER POSITION VS. PARALLEL MOVEMENT CHARACTERISTICS

E4B-T1E4

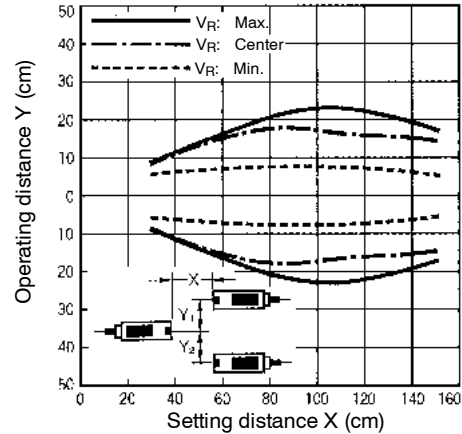

Installation

■ INDICATORS

1. STABILITY Indicator (Green)

When this indicator is lit, the ultrasonic input into the Receiver is sufficient, or its interruption is small enough, to ensure the smooth operation of the E4B. Do not operate the E4B when this indicator is not lit.

2. SENSING Indicator (Red)

When this indicator is lit, the Receiver has ultrasonic input.

■ INDICATOR OF THROUGH-BEAM EMITTER

1. Incident Indicator

Lit when ultrasonic signal detected.

To use this indicator of the Emitter as a SENSING indicator like the indicator on the Receiver, connect the black lead wires of the Emitter and Receiver together.

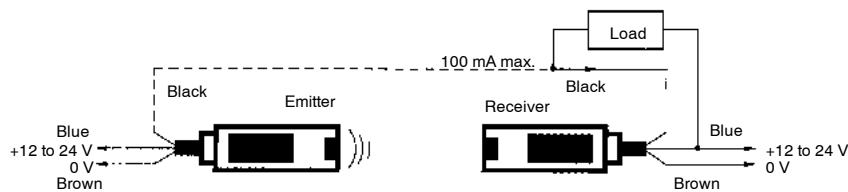

Note: Be sure not to make mistakes in polarity when connecting the above wires. In other words, both brown lead wires must connect to +VDC or 0 V and both blue lead wires must connect to 0 V or +VDC. Otherwise, the indicator of the Emitter will be lit when the ultrasonic beam is interrupted.

2. Power Indicator

Lit when the E4B is turned ON.

If the above connections are not possible (e.g., the Receiver and Emitter use different power supplies), this indicator will be used as a power indicator.

Connections of Black (White) Lead Wire of Emitter

| Power connection example | |
|--------------------------|-----------|
| Brown: +VDC Blue: 0 V | 0 V blue |
| Brown: 0 V Blue: +VDC | +VDC blue |

Note: The indicator will not be lit if the above wires are not connected correctly.

■ BEAM AXIS, SENSITIVITY, AND DISTANCE ADJUSTMENTS

1. E4B-T1 and E4B-TS50 Through-beam Models

Set the SENSITIVITY adjuster of the Receiver to maximum.

Move the Emitter and Receiver vertically and horizontally until the SENSING indicator of the Receiver is lit and secure the Emitter and Receiver at the midpoint of the range within which the STABILITY indicator is lit.

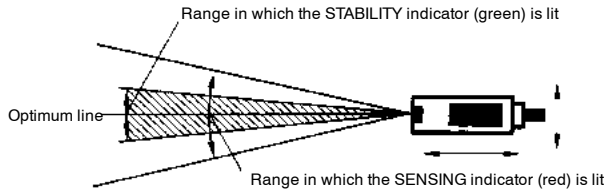

Pass the sensing object through the sensing range and adjust the sensitivity so that the SENSING indicator turns ON and OFF according to the presence or absence of the sensing object while the STABILITY indicator is lit continuously.

If the STABILITY indicator is not lit while the Sensor is in operation, this may indicate a possible operational error. Check or readjust the sensitivity.

If the Emitter and Receiver are set at a distance shorter than the rated sensing distance, reduce the sensitivity to within the range in which the STABILITY indicator is lit. This will increase the immunity of the Sensor against noise.

The parallel movement characteristics (i.e., the mutual interference distance) and sensing object size vary with the sensitivity adjustment. Refer to *Engineering Data* and make the optimum adjustments.

2. E4B-LS20 and E4B-LS70 Distance Setting Models

Locate the Sensor so that both the STABILITY and SENSING indicators will be lit when the object is placed at the sensing position, and the STABILITY indicator will be lit and the SENSING indicator will turn OFF when the object is removed.

| Step | 1 | 2 | 3 |
|----------------------|--|--|---|
| Sensing | | | |
| Distance adjuster | | --- | --- |
| Adjustment procedure | Place the sensing object at the sensing position and turn the distance adjuster clockwise gradually until both the SENSING and STABILITY indicators are lit. | Rotate the sensor vertically and horizontally and secure the sensor at the midpoint of the range within which the STABILITY indicator is on. | Remove the sensing object and check that the SENSING indicator is OFF and the STABILITY indicator is continuously on. |

Note: If the STABILITY indicator is not lit while the Sensor is in operation, this indicates a possible operational error. Check or readjust the sensitivity.

E4B-LS20

The sensing distance is adjustable within a range of 10 to 20 cm with the distance adjuster.

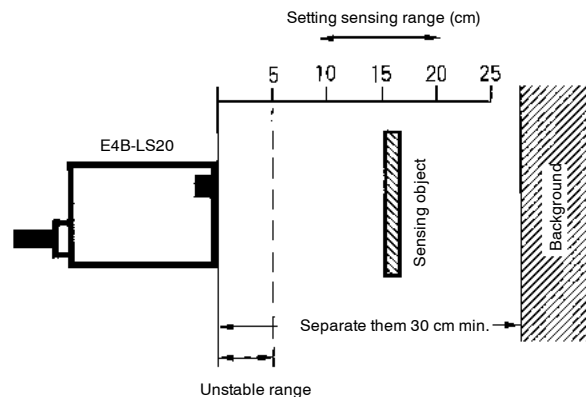

| Sensing distance | Position of distance adjuster |
|------------------|---|
| 5 to 10 cm | Set to the position 5-20. The distance range will be 5 to 23 cm in this case due to the characteristics of the ultrasonic beam. |
| 10 to 20 cm | The adjuster can be set freely within a range of 10 to 20 cm. The object can be detected within a range of 5 to 10 cm in this case due to multiple ultrasonic reflection. |



3. E4B-RS70 Reflective Zone

Target Reflective

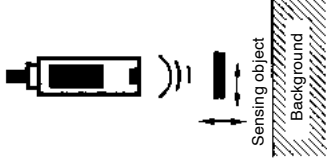
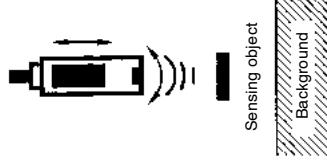
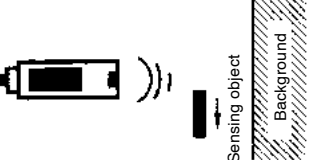
Locate the Sensor so that both the STABILITY and SENSING indicators will be lit when the sensing object is placed at the sensing position and the STABILITY indicator will be lit and the SENSING indicator will be off when the sensing object is removed.

| Step | 1 | 2 | 3 |
|----------------------|--|--|---|
| Sensing |  |  |  |
| Distance selector |  | --- | --- |
| Adjustment procedure | Place the sensing object at the sensing position and turn the distance selector clockwise gradually until both the SENSING and STABILITY indicators are lit. | Rotate the sensor vertically and horizontally and secure the sensor at the midpoint of the range within which the STABILITY indicator is on. | Remove the sensing object and check that the SENSING indicator is OFF and the STABILITY indicator is continuously on. |

Note: 1. If the STABILITY indicator is not lit while the Sensor is in operation, this indicates a possible operational error. Check or readjust the sensitivity.

2. If the background object is within a distance of 1.5 m from the sensing head, the SENSING indicator may be lit and the STABILITY indicator may not be lit in spite of the absence of the sensing object. Sensitivity should be reduced until STABILITY indicator turns on. Re-check operation with object present. If stable operation still does not occur, background may need to be relocated.

Background Reflective

This method allows the stable detection of objects under irregular and unstable reflection conditions (e.g., if the sensing objects are different in surface or size, if they are passed through diagonally, or if they are sound absorbant).

The sensor is adjusted to detect the background, Acoustic Reflector, rather than the target directly. When the target is present, it blocks detection of the Acoustic Reflector.

The Acoustic Reflector must be at least 4 x 4 cm in size and made of a material that is efficiently reflective (such as a metal plate).

Be sure that the target is not set within the sensing range.

Set the distance selector to the desired position, fix the reflector around the midpoint of the set sensing range, and check that both the SENSING and STABILITY indicators are lit.

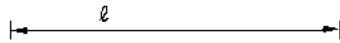
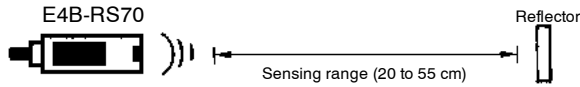

l: Near the midpoint of the sensing range (e.g., 45, 55, or 65 cm)

| Step | 1 | 2 | 3 |
|----------------------|---|--|---|
| Sensing | | | |
| Distance selector | | --- | --- |
| Adjustment procedure | Set the distance selector to the desired zone position, mount the Reflector at or near the midpoint of the set zone, and confirm that both the STABILITY and SENSING indicators are on. | Rotate the sensor vertically and horizontally and secure the Emitter and Receiver at the midpoint of the range within which the STABILITY indicator is on. | Remove the sensing object and check that the SENSING indicator is OFF and the STABILITY indicator is continuously on. |

- Note: 1. If the STABILITY indicator is not lit while the Sensor is in operation, this indicates a possible operational error. Check or readjust the sensitivity.
2. If the object is in position A parallel to the Reflector as shown above, the SENSING indicator may be lit and the STABILITY indicator may not be lit depending on the position of the sensing object. In such a case, give priority to the adjustment of the STABILITY indicator when the beam is incident by means of the reflector.

Dimensions

Unit: mm (inch)

■ **E4B-TS50**
E4B-T1
E4B-LS20
E4B-LS70
E4B-RS70

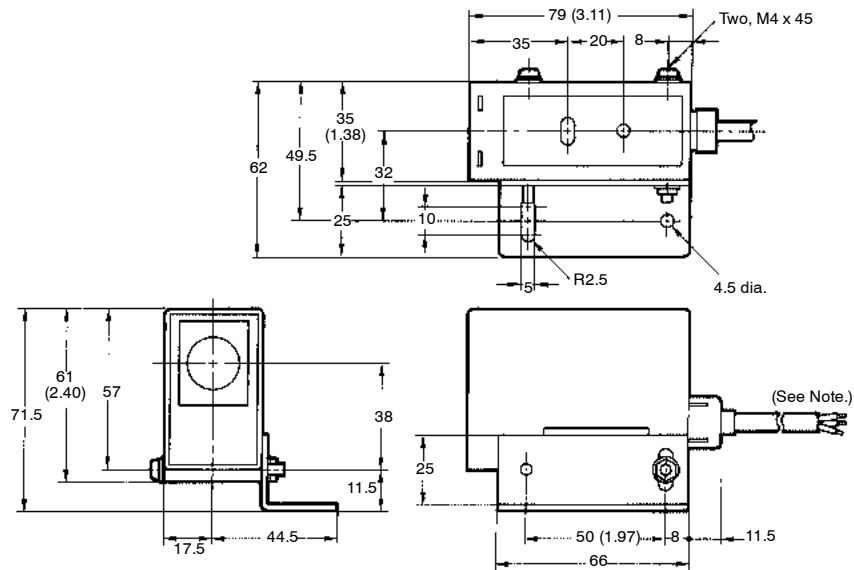
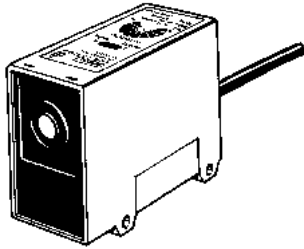

Note: Vinyl-insulated round cable with three conductors, 6 dia.; standard length: 2 m

Precautions

■ SENSOR MOUNTING ANGLE

If the E4B is in level control or distance control of sensing objects, the stability of signal detection will depend on the sensing surface condition of the objects. Considering the repose angle of the objects, mount the E4B so that the ultrasonic beam and the sensing surface of each object meet at right angles to each other.

■ SURROUNDING OBJECTS

Make sure that the Sensor is free from surrounding objects that reflect the ultrasonic beam diffusion, otherwise the Sensor may malfunction. In particular, pay the utmost attention so that no side lobe of the ultrasonic beam will be reflected by such objects.

■ MOUNTING

Securely mount the E4B by using the nuts provided with the E4B or the mounting holes of the E4B. Refer to *Dimensions* for details.

Do not strike the Sensor with hammer or other object, otherwise the E4B will no longer be water-resistant.

If the E4B is not mounted securely, the E4B may be damaged by vibration or may not detect target objects accurately due to a possible change in the mounting position.

■ ENVIRONMENTAL CONDITIONS

Do not use the E4B at a temperature exceeding the rated range or outdoors, otherwise the reliability and life of the E4B will decrease.

The Ultrasonic Reflective Sensor utilizes the air as a beam transmission media. Do not use the E4B in places with radical convection or extreme local temperature changes. For example, if there is a hot air curtain that causes turbulence within the sensing area, the E4B may malfunction.

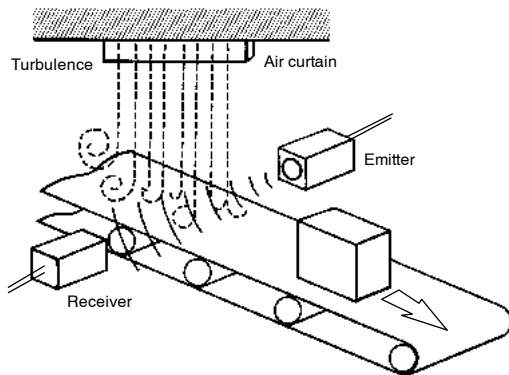

The jetting sound of air nozzles includes noise of a wide frequency range, which will affect the operation of the E4B. Do not use an air nozzle near the E4B.

The sensing distance of the E4B will decrease if there is any water drops on the surface of the emitter or receiver.

The through-beam model may not detect any objects if there is any object absorbing sound, such as powder and cotton, on the surface of the emitter or receiver.

NOTE: DIMENSIONS SHOWN ARE IN MILLIMETERS. To convert millimeters to inches divide by 25.4.

OMRON[®]
OMRON ELECTRONICS LLC
One East Commerce Drive
Schaumburg, IL 60173
1-800-55-OMRON

OMRON ON-LINE
Global - <http://www.omron.com>
USA - <http://www.omron.com/oei>
Canada - <http://www.omron.com/oci>

OMRON CANADA, INC.
885 Milner Avenue
Scarborough, Ontario M1B 5V8
416-286-6465