

Hyper 3 mm (T1) LED, Non Diffused Hyper-Bright LED

LB 3333, LV 3333, LT 3333



LV 3333 abgekündigt nach PD_078_02
LV 3333 obsolete acc. to PD_078_02

Besondere Merkmale

- **Gehäusotyp:** nicht eingefärbtes, klares 3 mm (T1) Gehäuse
- **Besonderheit des Bauteils:** enge Abstrahlcharakteristik; Lötspieße mit Aufsetzebene
- **Wellenlänge:** 470 nm (blau), 505 nm (verde), 528 nm (true green)
- **Abstrahlwinkel:** 30°
- **Technologie:** InGaN
- **optischer Wirkungsgrad:** 2 lm/W (blau), 6 lm/W (verde), 8 lm/W (true green)
- **Gruppierungsparameter:** Lichtstärke, Wellenlänge
- **Lötmethode:** Wellenlöten (TTW)
- **Verpackung:** Schüttgut, gegurtet lieferbar
- **ESD-Festigkeit:** ESD-sicher bis 2 kV nach EOS/ESD-5.1-1993

Anwendungen

- Informationsanzeigen im Außenbereich
- optischer Indikator
- Signal- und Symbolleuchten
- Markierungsbeleuchtung (z.B. Stufen, Fluchtwege, u.ä.)

Features

- **package:** colorless, clear 3 mm (T1) package
- **feature of the device:** narrow viewing angle, solder leads with stand-off
- **wavelength:** 470 nm (blue), 505 nm (verde), 528 nm (true green)
- **viewing angle:** 30°
- **technology:** InGaN
- **optical efficiency:** 2 lm/W (blue), 6 lm/W (verde), 8 lm/W (true green)
- **grouping parameter:** luminous intensity, wavelength
- **soldering methods:** TTW soldering
- **packing:** bulk, available taped on reel
- **ESD-withstand voltage:** up to 2 kV acc. to EOS/ESD-5.1-1993

Applications

- outdoor displays
- optical indicators
- signal and symbol luminaire
- marker lights (e.g. steps, exit ways, etc.)

Typ Type	Emissions- farbe Color of Emission	Gehäusefarbe Color of Package	Lichtstärke Luminous Intensity $I_F = 20 \text{ mA}$ $I_V \text{ (mcd)}$	Lichtstrom Luminous Flux $I_F = 20 \text{ mA}$ $\Phi_V \text{ (mlm)}$	Bestellnummer Ordering Code
LB 3333-PR-35 LB 3333-RT-35	blue	colorless clear	45 ... 180 112 ... 450	110 (typ.) 280 (typ.)	Q65110A0463 Q65110A0117
■ LV 3333-SAW-35	verde	colorless clear	180 ... 1800	950 (typ.)	Q62703Q4916
LT 3333-TV-35 LT 3333-VBW-35	true green	colorless clear	280 ... 1120 710 ... 2800	700 (typ.) 1750 (typ.)	Q65110A0469 Q65110A0468

- LV 3333 abgekündigt nach PD_078_02 / LV 3333 obsolete acc. to PD_078_02
 Letzte Bestellung / Last Order: 30.09.2003
 Letzte Lieferung / Last Delivery: 31.03.2004

Anm.: -35 gesamter Farbbereich, Lieferung in Einzelgruppen (siehe Seite 5)

Die Standardlieferform von Serientypen beinhaltet eine untere bzw. eine obere Familiengruppe oder mindestens zwei Einzelgruppen.

In einer Verpackungseinheit / Gurt ist immer nur eine Helligkeitsgruppe enthalten.

Die technologiebedingte Helligkeits-Streuung der heutigen LED-Herstellprozesse über einen längeren Fertigungszeitraum (Halbleitermaterial - Chipherstellung - Montageprozess) erlaubt keine Zusage einer einzelnen Helligkeitsgruppe. Daher müssen mindestens zwei Helligkeitsgruppen vorgesehen werden!

Note: -35 Total color tolerance range, delivery in single groups (please see page 5)

The standard shipping format for serial types includes a lower or upper family group or at least two individual groups.

No packing unit / tape ever contains more than one luminous intensity group.

Luminosity variations caused by the technology used in current LED manufacturing processes over a protracted manufacturing period (semiconductor material - chip fabrication - assembly process) mean that it is not possible to assign LEDs to a single luminous intensity group. For this reason at least two luminous intensity groups must be provided!

Bezeichnung Parameter	Symbol Symbol	Wert Value		Einheit Unit
		LB	LV, LT	
Betriebstemperatur Operating temperature range	T_{op}	- 55 ... + 100		°C
Lagertemperatur Storage temperature range	T_{stg}	- 55 ... + 100		°C
Sperrschichttemperatur Junction temperature	T_j	+ 100		°C
Durchlassstrom Forward current	I_F	20		mA
Stoßstrom Surge current $t \leq 10 \mu s, D = 0.005$	I_{FM}	200	250	mA
Sperrspannung ¹⁾ Reverse voltage	V_R	5		V
Leistungsaufnahme Power consumption $T_A \leq 25 \text{ °C}$	P_{tot}	80		mW
Wärmewiderstand ²⁾ Thermal resistance Sperrschicht/Umgebung Junction/ambient Sperrschicht/Löt看pad Junction/solder point Montage auf PC-Board FR 4 (Padgröße $\geq 16 \text{ mm}^2$) mounted on PC board FR 4 (pad size $\geq 16 \text{ mm}^2$) Minimale Beinchenlänge Minimum lead length	$R_{th JA}$ $R_{th JS}$	400 180	K/W K/W	

1) für kurzzeitigen Betrieb geeignet / suitable for short term application

2) R_{th} erhöht sich um 13 K/W pro mm Beinchenlänge.
Each additional 1 mm of lead length increases R_{th} by 13 K/W.

Bezeichnung Parameter	Symbol Symbol	Werte Values			Einheit Unit
		LB	LV	LT	
Wellenlänge des emittierten Lichtes Wavelength at peak emission $I_F = 20 \text{ mA}$	(typ.) λ_{peak}	465	503	523	nm
Dominantwellenlänge ¹⁾ Dominant wavelength $I_F = 20 \text{ mA}$	(typ.) λ_{dom}	470 ± 6	505 ± 7	528 ± 9	nm
Spektrale Bandbreite bei 50 % $I_{\text{rel max}}$ Spectral bandwidth at 50 % $I_{\text{rel max}}$ $I_F = 20 \text{ mA}$	(typ.) $\Delta\lambda$	25	30	33	nm
Abstrahlwinkel bei 50 % I_V (Vollwinkel) Viewing angle at 50 % I_V	(typ.) 2ϕ	30	30	30	Grad deg.
Durchlassspannung ²⁾ Forward voltage $I_F = 20 \text{ mA}$	(min.) V_F (typ.) V_F (max.) V_F	2.9 3.5 3.9	2.9 3.3 3.9	2.9 3.3 3.9	V V V
Sperrstrom Reverse current $V_R = 5 \text{ V}$	(typ.) I_R (max.) I_R	0.01 10	0.01 10	0.01 10	μA μA
Temperaturkoeffizient von λ_{peak} Temperature coefficient of λ_{peak} $I_F = 20 \text{ mA}; -10^\circ\text{C} \leq T \leq 100^\circ\text{C}$	(typ.) $TC_{\lambda_{\text{peak}}}$	0.04	0.03	0.04	nm/K
Temperaturkoeffizient von λ_{dom} Temperature coefficient of λ_{dom} $I_F = 20 \text{ mA}; -10^\circ\text{C} \leq T \leq 100^\circ\text{C}$	(typ.) $TC_{\lambda_{\text{dom}}}$	0.03	0.04	0.04	nm/K
Temperaturkoeffizient von V_F Temperature coefficient of V_F $I_F = 20 \text{ mA}; -10^\circ\text{C} \leq T \leq 100^\circ\text{C}$	(typ.) TC_V	- 4.5	- 3.6	- 3.6	mV/K
Optischer Wirkungsgrad Optical efficiency $I_F = 20 \text{ mA}$	(typ.) η_{opt}	2	6	8	lm/W

¹⁾ Wellenlängengruppen werden mit einer Stromeinprägedauer von 25 ms und einer Genauigkeit von $\pm 1 \text{ nm}$ ermittelt.
Wavelength groups are tested at a current pulse duration of 25 ms and a tolerance of $\pm 1 \text{ nm}$.

²⁾ Durchlassspannungsgruppen werden mit einer Stromeinprägedauer von 1 ms und einer Genauigkeit von $\pm 0,05 \text{ V}$ ermittelt.
Forward voltage groups are tested at a current pulse duration of 1 ms and a tolerance of $\pm 0.05 \text{ V}$.

1) Wellenlängengruppen / Wavelength groups

Gruppe Group	blue		verde		true green		Einheit Unit
	min.	max.	min.	max.	min.	max.	
3	464	468	498	503	519	525	nm
4	468	472	503	507	525	531	nm
5	472	476	507	512	531	537	nm

Helligkeits-Gruppierungsschema
Luminous Intensity Groups

Lichtgruppe Luminous Intensity Group	Lichtstärke Luminous Intensity I_V (mcd)	Lichtstrom Luminous Flux Φ_V (mlm)
P	45 ... 71	60 (typ.)
Q	71 ... 112	90 (typ.)
R	112 ... 180	150 (typ.)
S	180 ... 280	240 (typ.)
T	280 ... 450	380 (typ.)
U	450 ... 710	590 (typ.)
V	710 ... 1120	940 (typ.)
AW	1120 ... 1800	1500 (typ.)
BW	1800 ... 2800	2300 (typ.)

Helligkeitswerte werden mit einer Stromeinprägedauer von 25 ms und einer Genauigkeit von $\pm 11\%$ ermittelt.
Luminous intensity is tested at a current pulse duration of 25 ms and a tolerance of $\pm 11\%$.

Relative spektrale Emission $I_{rel} = f(\lambda)$, $T_A = 25\text{ }^\circ\text{C}$, $I_F = 20\text{ mA}$

Relative Spectral Emission

$V(\lambda)$ = spektrale Augenempfindlichkeit
Standard eye response curve

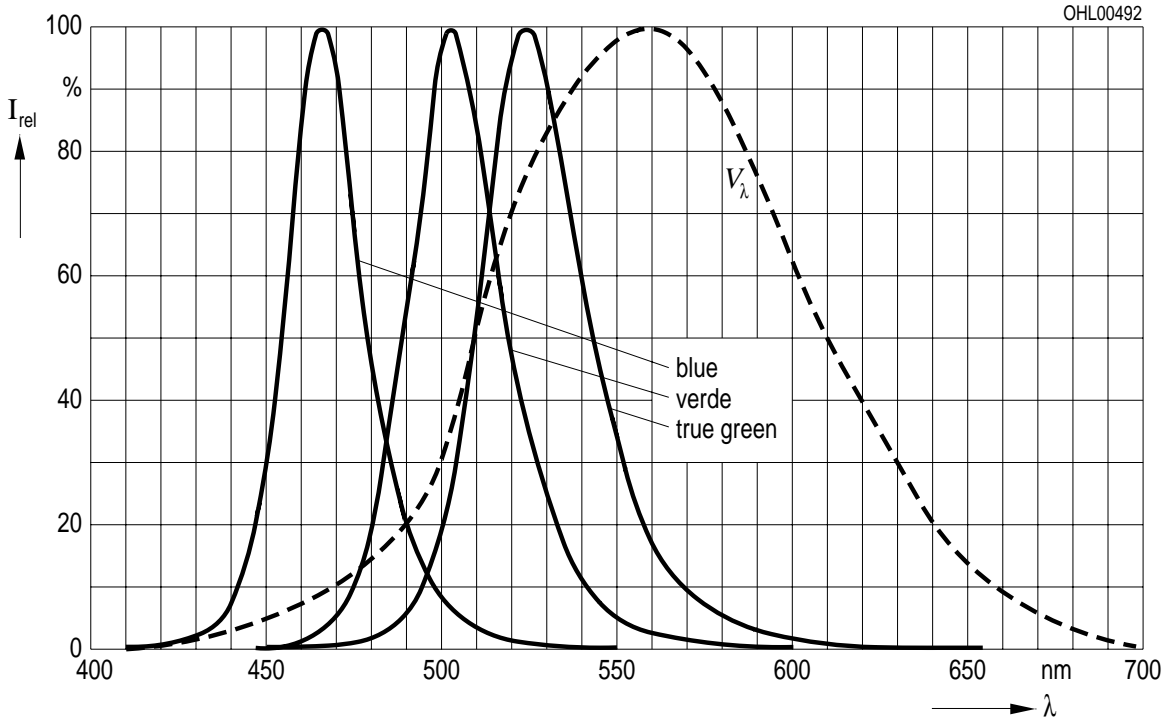

Abstrahlcharakteristik $I_{rel} = f(\varphi)$

Radiation Characteristic

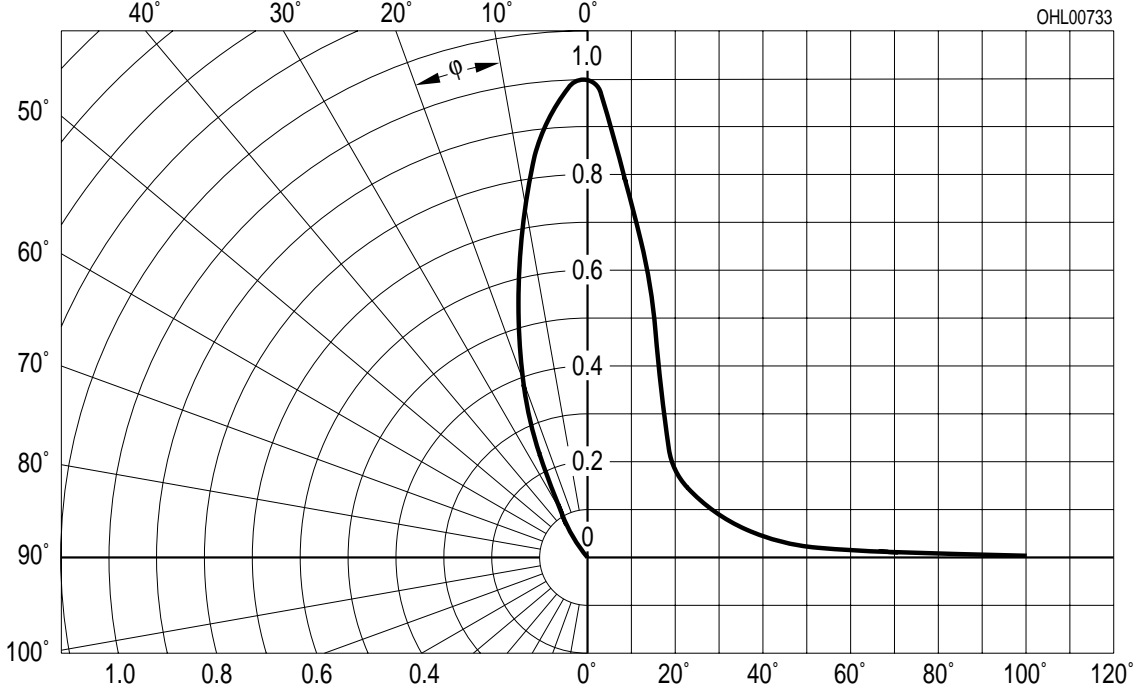

Durchlassstrom $I_F = f(V_F)$
Forward Current

$T_A = 25\text{ }^\circ\text{C}$

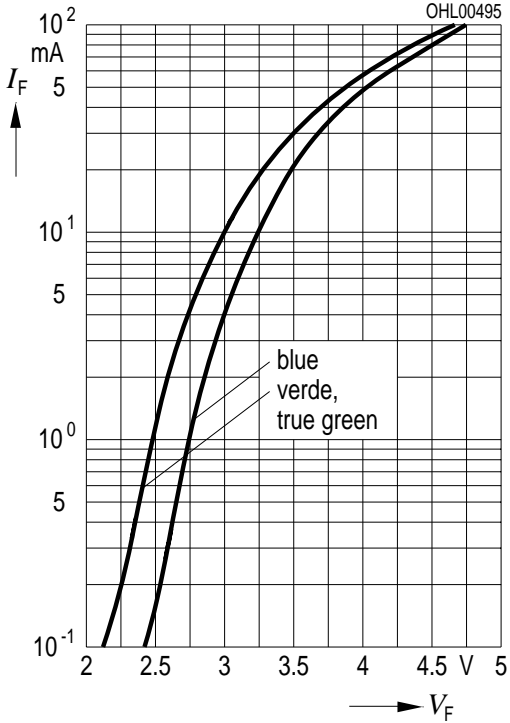

Relative Lichtstärke $I_V/I_{V(20\text{ mA})} = f(I_F)$
Relative Luminous Intensity

$T_A = 25\text{ }^\circ\text{C}$

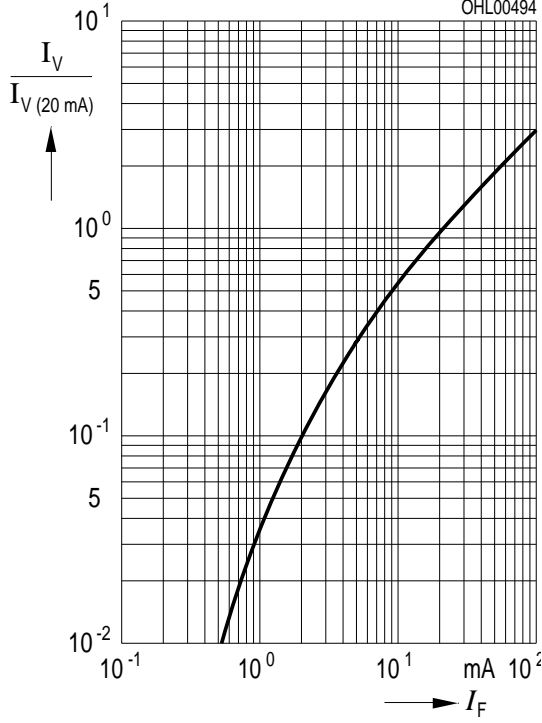

Maximal zulässiger Durchlassstrom $I_F = f(T)$
Max. Permissible Forward Current

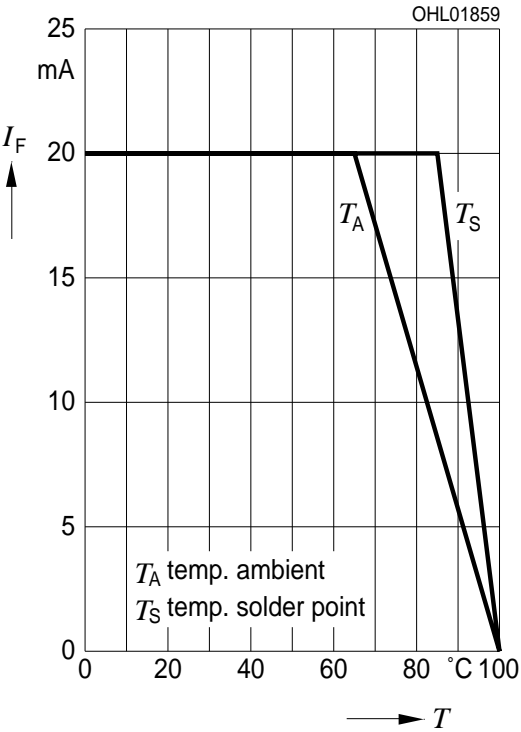

Relative Lichtstärke $I_V/I_{V(25\text{ }^\circ\text{C})} = f(T_A)$
Relative Luminous Intensity

$I_F = 20\text{ mA}$

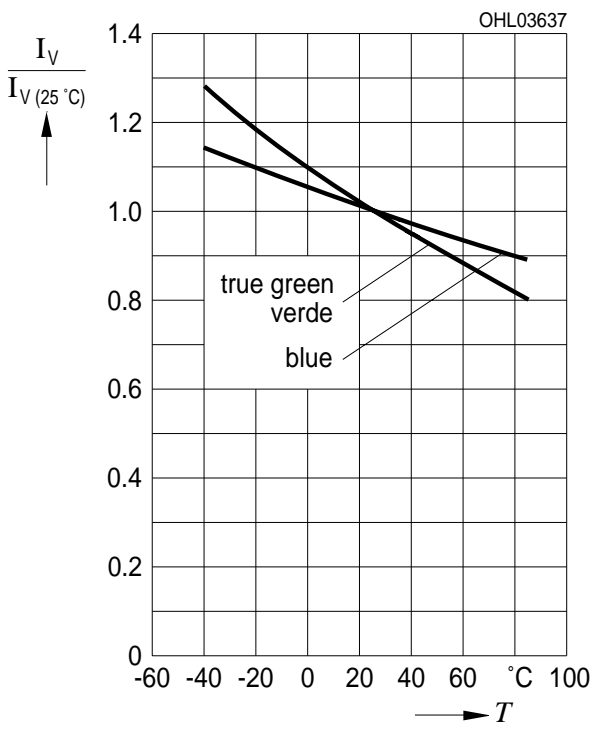

Dominante Wellenlänge $\lambda_{dom} = f(I_F)$
Dominant Wavelength

LB, $T_A = 25\text{ °C}$

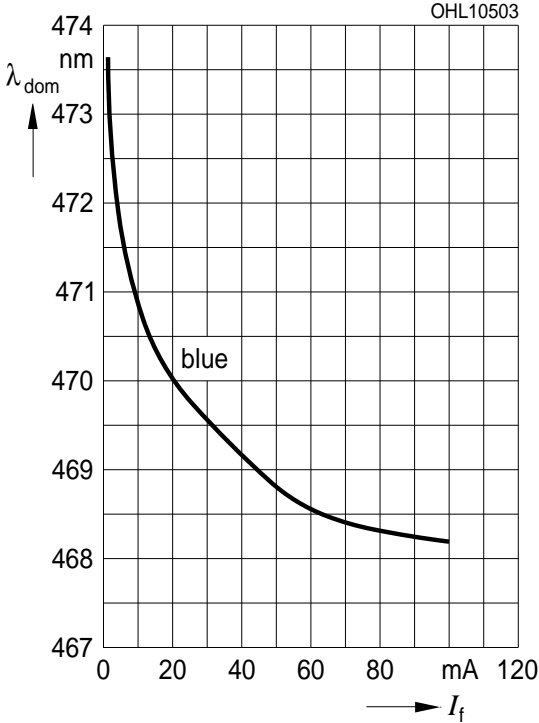

Dominante Wellenlänge $\lambda_{dom} = f(I_F)$
Dominant Wavelength

LV, $T_A = 25\text{ °C}$

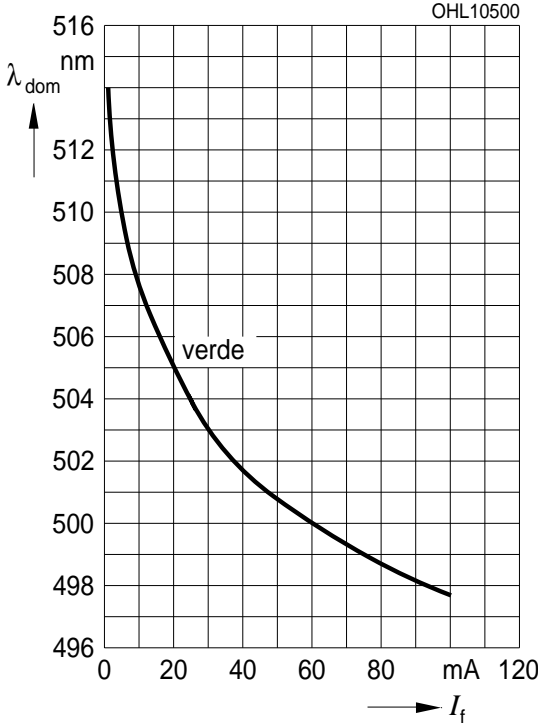

Dominante Wellenlänge $\lambda_{dom} = f(I_F)$
Dominant Wavelength

LT, $T_A = 25\text{ °C}$

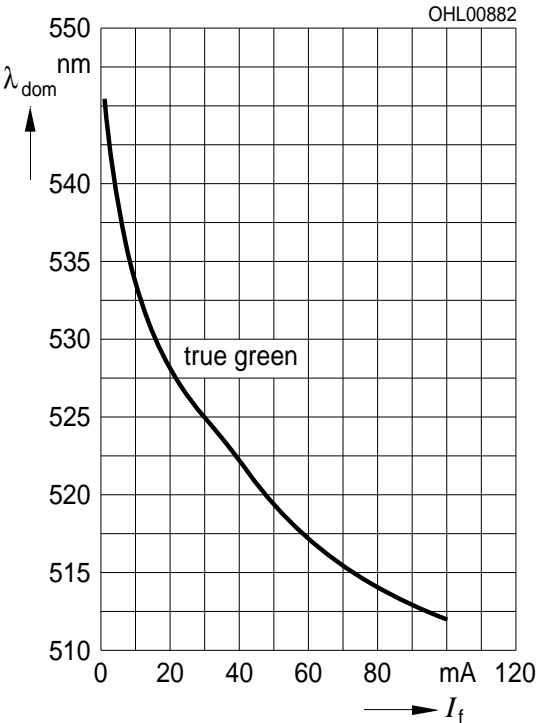

Zulässige Impulsbelastbarkeit $I_F = f(t_p)$
Permissible Pulse Handling Capability
Duty cycle $D =$ parameter, $T_A = 25\text{ °C}$
LB

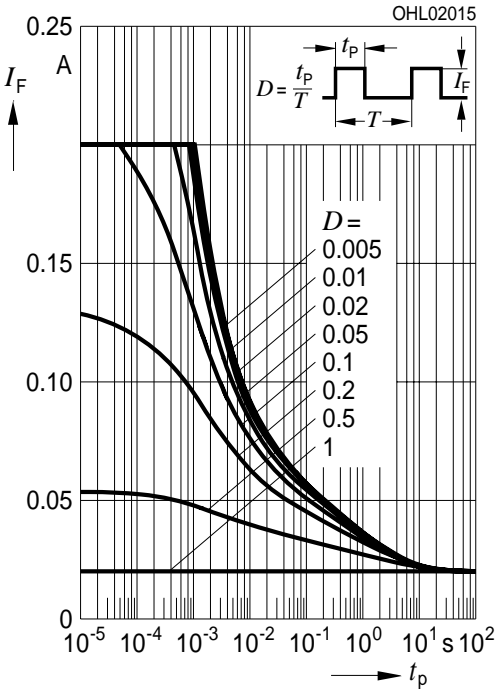

Zulässige Impulsbelastbarkeit $I_F = f(t_p)$
Permissible Pulse Handling Capability
Duty cycle $D =$ parameter, $T_A = 85\text{ °C}$
LB

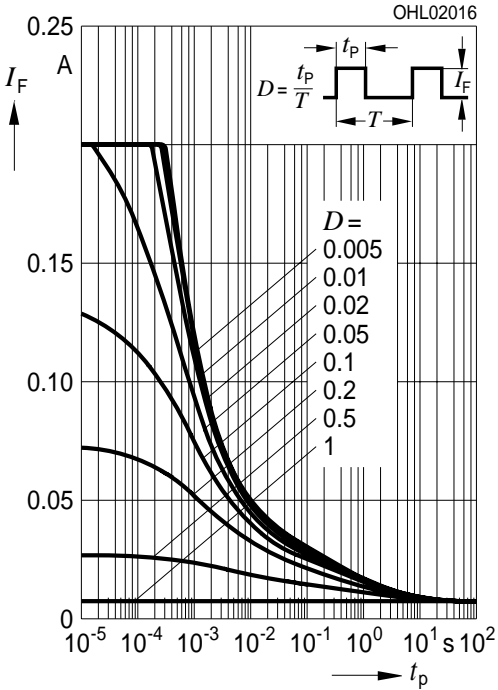

Zulässige Impulsbelastbarkeit $I_F = f(t_p)$
Permissible Pulse Handling Capability
Duty cycle $D =$ parameter, $T_A = 25\text{ °C}$
LV, LT

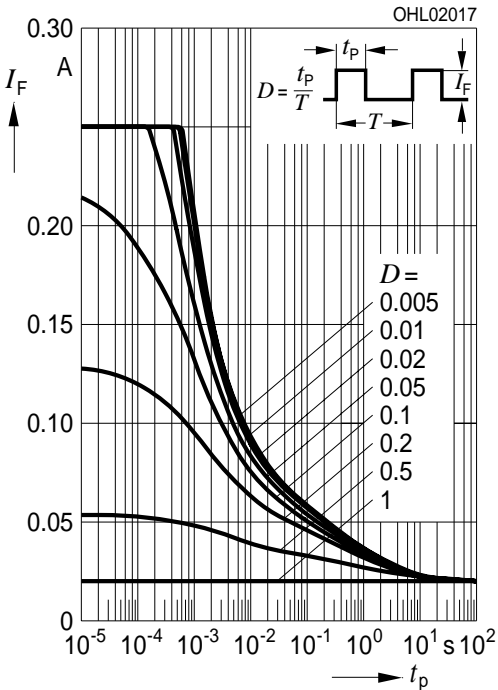

Zulässige Impulsbelastbarkeit $I_F = f(t_p)$
Permissible Pulse Handling Capability
Duty cycle $D =$ parameter, $T_A = 85\text{ °C}$
LV, LT

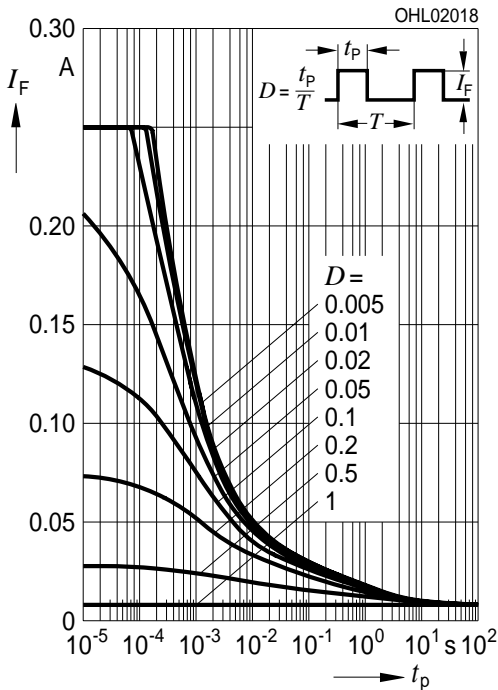

Maßzeichnung
Package Outlines

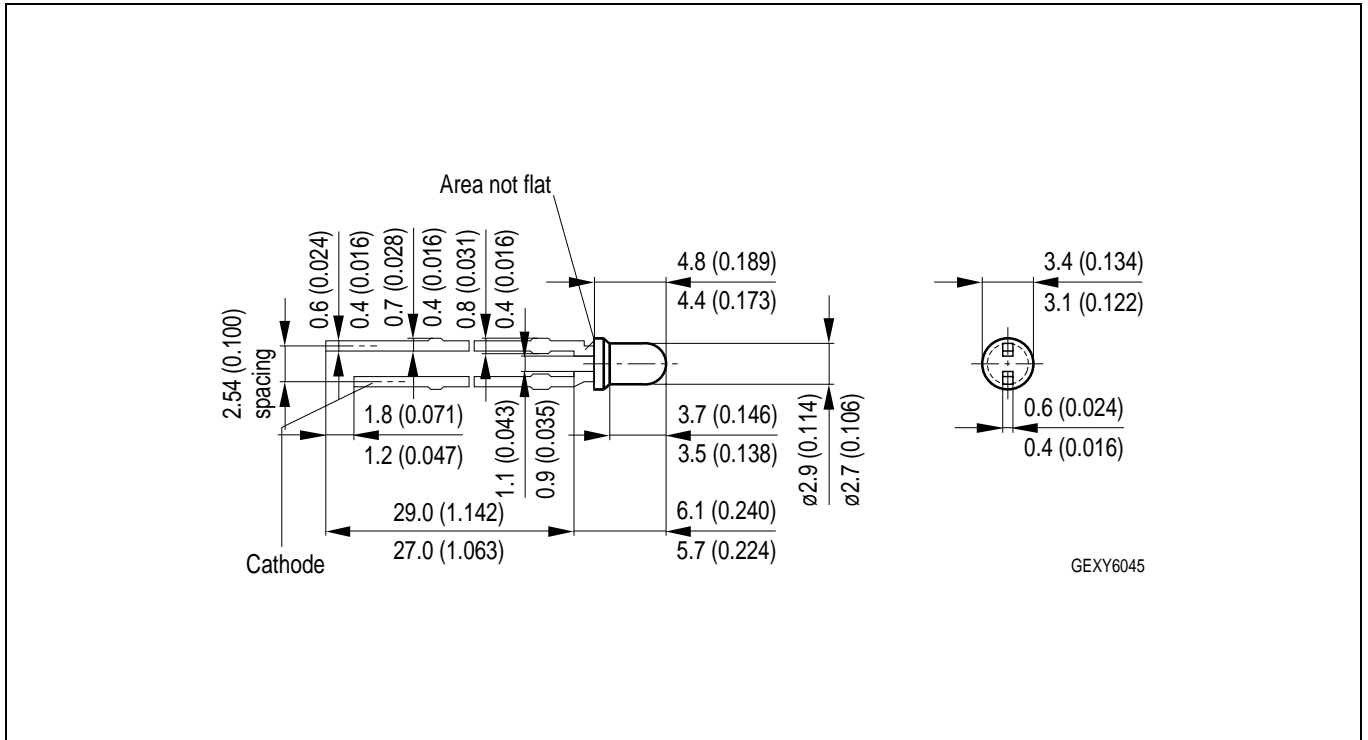

Maße werden wie folgt angegeben: mm (inch) / Dimensions are specified as follows: mm (inch).

Kathodenkennung: kürzerer Lötspieß
Cathode mark: short solder lead
Gewicht / Approx. weight: 0.15 g

Lötbedingungen
Soldering Conditions

Wellenlöten (TTW)(nach CECC 00802)
TTW Soldering(acc. to CECC 00802)

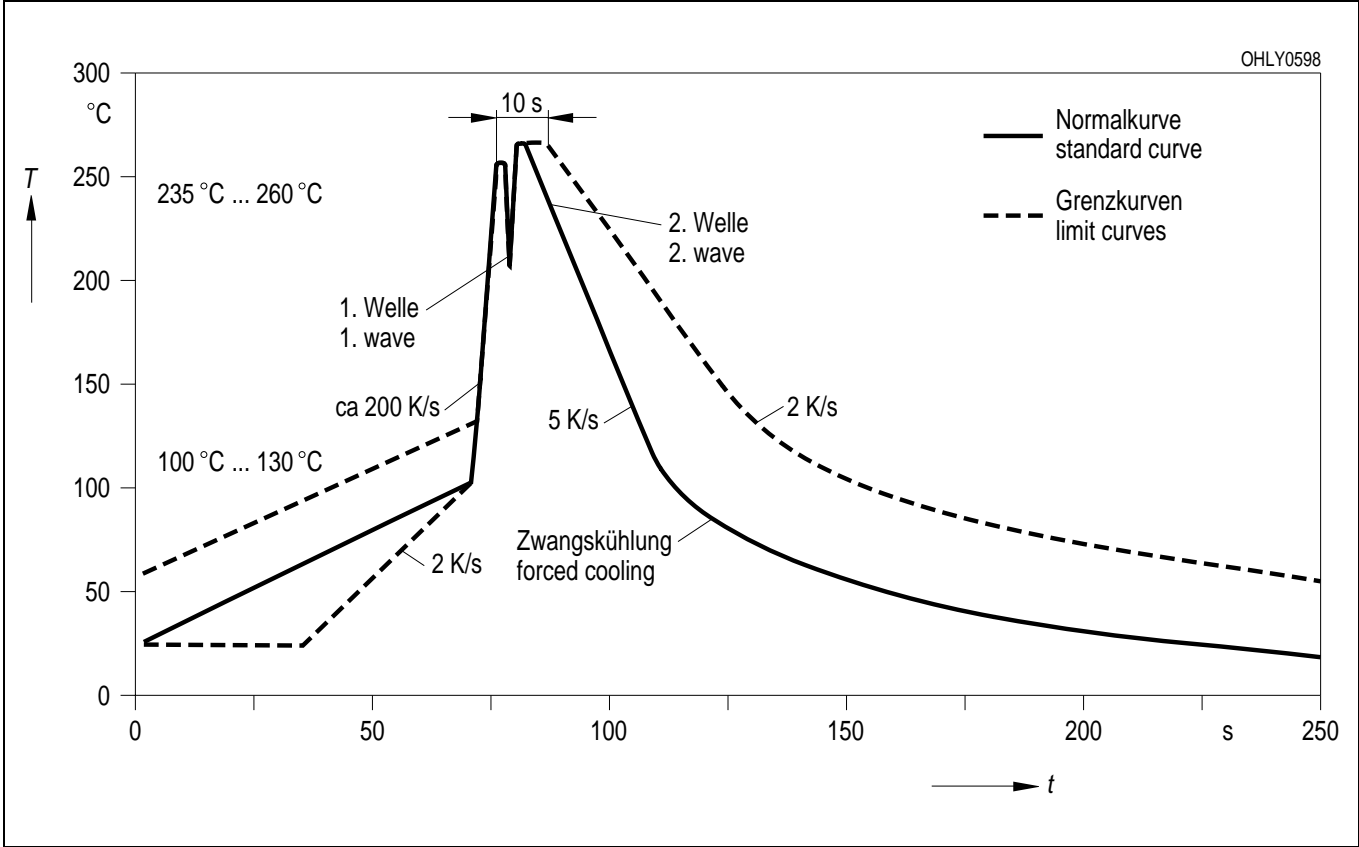

Empfohlenes Lötpaddesign Wellenlöten (TTW)
Recommended Solder Pad TTW Soldering

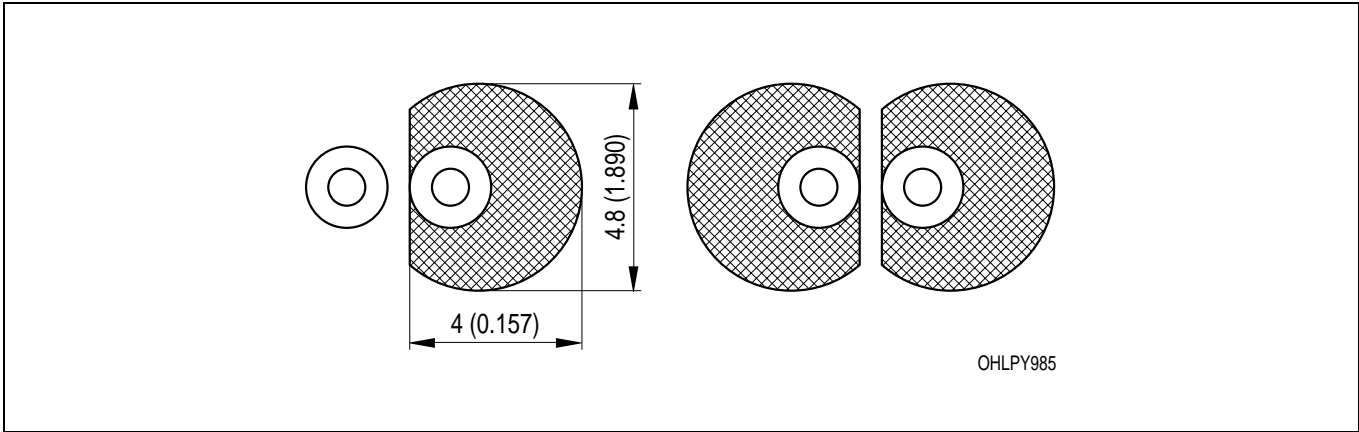

Maße werden wie folgt angegeben: mm (inch) / Dimensions are specified as follows: mm (inch).

Revision History: 2003-08-04		Date of change
Previous Version: 2003-07-07		
Page	Subjects (major changes since last revision)	
1, 2	verde: obsolete	2003-08-04

Published by OSRAM Opto Semiconductors GmbH
Wernerwerkstrasse 2, D-93049 Regensburg

© All Rights Reserved.

Attention please!

The information describes the type of component and shall not be considered as assured characteristics. All typical data and graphs are basing on representative samples, but don't represent the production range. If requested, e.g. because of technical improvements, these typ. data will be changed without any further notice.

Terms of delivery and rights to change design reserved. Due to technical requirements components may contain dangerous substances. For information on the types in question please contact our Sales Organization.

If printed or downloaded, please find the latest version in the Internet.

Packing

Please use the recycling operators known to you. We can also help you – get in touch with your nearest sales office. By agreement we will take packing material back, if it is sorted. You must bear the costs of transport. For packing material that is returned to us unsorted or which we are not obliged to accept, we shall have to invoice you for any costs incurred.

Components used in life-support devices or systems must be expressly authorized for such purpose! Critical components ¹ may only be used in life-support devices or systems ² with the express written approval of OSRAM OS.

¹ A critical component is a component used in a life-support device or system whose failure can reasonably be expected to cause the failure of that life-support device or system, or to affect its safety or the effectiveness of that device or system.

² Life support devices or systems are intended (a) to be implanted in the human body, or (b) to support and/or maintain and sustain human life. If they fail, it is reasonable to assume that the health of the user may be endangered.