

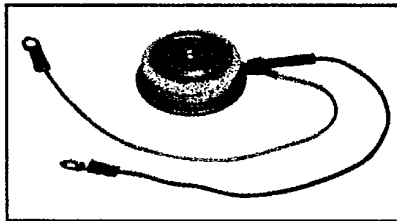

C380

Powerex, Inc. Hillis Street, Youngwood, Pennsylvania 15697 (412) 925-7272
 Powerex Europe, S.A., 428 Ave. G. Durand, BP107, 72003 LeMans, France (43) 72.75.15

Phase Control SCR
250 Amperes Avg
100-1300 Volts

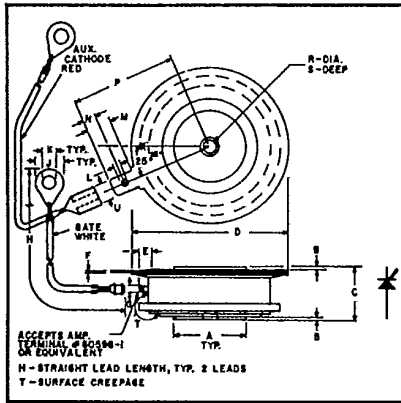

C380
Phase Control SCR
 250 Amperes/100-1300 Volts

TO-200
Outline Drawing

Dimensions	Inches		Millimeters	
	Min.	Max.	Min.	Max.
A	.744	.752	18.897	19.101
B	.030	.060	.762	1.524
C	.515	.565	13.081	14.351
D	1.600	1.656	40.64	42.06
E	.110	—	2.794	—
F	.013	.017	.330	.432
G	.057	.059	1.447	1.449
H	7.980	8.115	202.70	206.11
J	—	.300	—	7.620
K	.137	.153	3.479	3.886
L	.065	.070	1.651	1.778
M	.245	.260	6.223	6.604
N	.120	.140	3.048	3.556
P	1.090	1.125	27.69	28.55
R	.135	.145	3.429	3.683
S	.067	.083	1.701	2.108
T	.340	—	8.636	—
U	.186	.189	4.724	4.801

Description

Powerex Silicon Controlled Rectifiers (SCR) are designed for phase control applications. These are all-diffused, Press-Pak (Pow-R-Disc) devices employing the field-proven amplifying (di/namic) gate.

Features:

- Low On-State Voltage
- High di/dt
- High dv/dt
- Hermetic Packaging
- Excellent Surge and I²t Ratings

Applications:

- Power Supplies
- Battery Chargers
- Motor Control
- Light Dimmers
- VAR Generators

Ordering Information

Example: Select the complete five or six digit part number you desire from the table - i.e. C380M is a 600 Volt, 250 Ampere Phase Control SCR.

Type	Voltage		Current
	V _{ORM} V _{RRM}	Code	
C380	100	A	250
	200	B	
	300	C	
	400	D	
	500	E	
	600	M	
	700	S	
	800	N	
	900	T	
	1000	P	
	1100	PA	
	1200	PB	
	1300	PC	



Powerex, Inc., Hillis Street, Youngwood, Pennsylvania 15697 (412) 925-7272

Powerex Europe, S.A., 428 Ave. G. Durand, BP107, 72003 LeMans, France (43) 72.75.15

C380

Phase Control SCR

250 Amperes Avg/100-1300 Volts

Absolute Maximum Ratings

	Symbol	C380	Units
RMS On-State Current	$I_{T(RMS)}$	400	Amperes
Average On-State Current	$I_{T(av)}$	250	Amperes
Peak One-Cycle Surge (Non Repetitive) On-State Current (60Hz)	I_{TSM}	3500	Amperes
Peak One-Cycle Surge (Non-Repetitive) On-State Current (50Hz)	I_{TSM}	3200	Amperes
Critical Rate-of-Rise of On-State Current (Non-Repetitive)	di/dt	800	Amperes/ μ s
Critical Rate-of-Rise of On-State Current (Repetitive)	di/dt	500	Amperes/ μ s
I^2t (for Fusing), 8.3 milliseconds	I^2t	50,000	A^2sec
Peak Gate Power Dissipation	P_{GM}	10	Watts
Average Gate Power Dissipation	$P_{G(av)}$	2	Watts
Storage Temperature	T_{STG}	-40 to 150	$^{\circ}C$
Operating Temperature	T_J	-40 to 125	$^{\circ}C$
Mounting Force [ⓐ]		720 to 880	lb.
Mounting Force [ⓐ]		3.2 to 3.92	kN

[ⓐ] Consult recommended mounting procedures.



Powerex, Inc., Hillis Street, Youngwood, Pennsylvania 15697 (412) 925-7272

Powerex Europe, S.A., 428 Ave. G. Durand, BP107, 72003 LeMans, France (43) 72.75.15

C380

Phase Control SCR

250 Amperes Avg/100-1300 Volts

Electrical and Thermal Characteristics

Characteristics	Symbol	Test Conditions	C380	Units
Voltage—Blocking State Maximums				
Forward Leakage, Peak	I_{DRM}	$T_J = 125^\circ\text{C}, V = V_{DRM}$	20	mA
Reverse Leakage, Peak	I_{RRM}	$T_J = 125^\circ\text{C}, V = V_{RRM}$	20	mA
Current—Conducting State Maximums				
Peak On-State Voltage	V_{TM}	$I_{TM} = 1500\text{A Peak}, T_C = 25^\circ\text{C}, \text{Duty Cycle} \leq 0.01\%$	2.85	Volts
Switching				
Typical Turn-Off Time	t_q	$T_J = 120^\circ\text{C}, I_{TM} = 250\text{ amps};$ $V_R = 50\text{ Volts Min.}; V_{DRM}$ (Reapplied); Rate-of-Rise of Reapplied Off-State; Voltage = 20 Volts/ μsec (Linear); Gate Bias During Turn-Off Interval = 0 Volts, 100 Ohms Duty Cycle $\leq 0.01\%$	200	μsec
Typical Delay Time	t_d	$T_J = 25^\circ\text{C}, I_T = 100\text{ Adc}, V_{DRM} = \text{Rated};$ Gate Supply: 10 Volt Open Circuit, 25 Ohm, 0.1 μsec max. rise time	1	μsec
Min. Critical dv/dt exponential to V_{DRM}	dv/dt	$T_J = 125^\circ\text{C}, \text{Gate Open}$	200	V/ μsec
Thermal				
Maximum Thermal Resistance [ⓐ] , double sided cooling				
Junction to Case	$R_{\theta JC}$.095	$^\circ\text{C}/\text{Watt}$
Case to Sink, Lubricated	$R_{\theta CS}$.02	$^\circ\text{C}/\text{Watt}$
Gate—Maximum Parameters				
Gate Current to Trigger	I_{GT}	$V_D = 6\text{V}, T_C = 25^\circ\text{C}, R_L = 3\Omega$	150	mA
Gate Voltage to Trigger	V_{GT}	$V_D = 6\text{V}, T_C = -40\text{ to }125^\circ\text{C}, R_L = 3\Omega$	3	Volts
Non-Triggering Gate Voltage	V_{GDM}	$T_J = 125^\circ\text{C}, \text{rated } V_{DRM}, R_L = 1000\Omega$.15	Volts
Peak Forward Gate Current	I_{GTM}		10	Amperes
Peak Reverse Gate Voltage	V_{GRM}		5	Volts

[ⓐ] Consult recommended mounting procedures.



Powerex, Inc., Hills Street, Youngwood, Pennsylvania 15697 (412) 925-7272

Powerex Europe, S.A., 428 Ave. G. Durand, BP107, 72003 LeMans, France (43) 72.75.15

C380

Phase Control SCR

250 Amperes Avg/100-1300 Volts

MAXIMUM ON-STATE CHARACTERISTICS

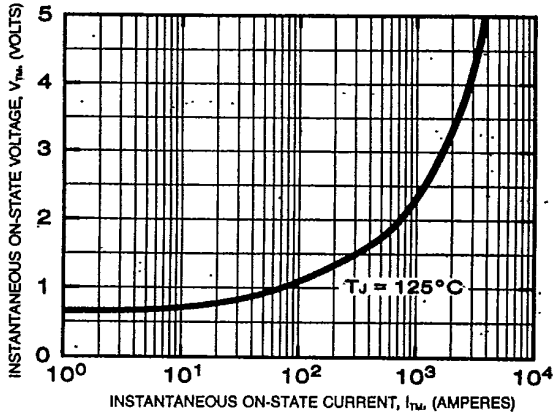

TRANSIENT THERMAL IMPEDANCE CHARACTERISTICS (JUNCTION TO CASE)

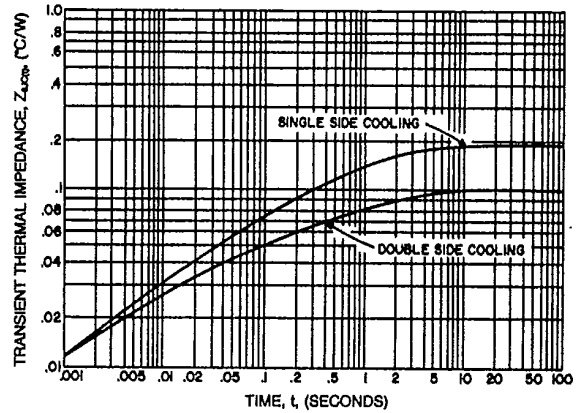

MAXIMUM ALLOWABLE CASE TEMPERATURE (SINUSOIDAL WAVEFORM)

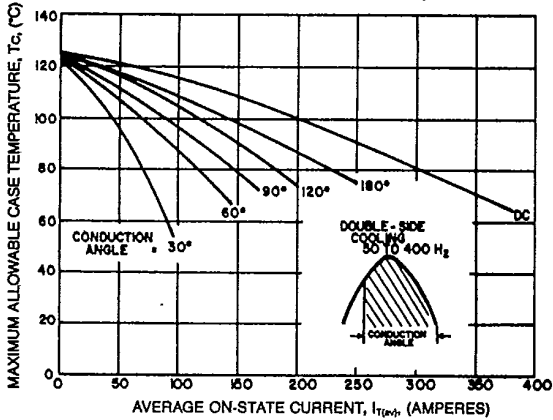

MAXIMUM ON-STATE POWER DISSIPATION (SINUSOIDAL WAVEFORM)

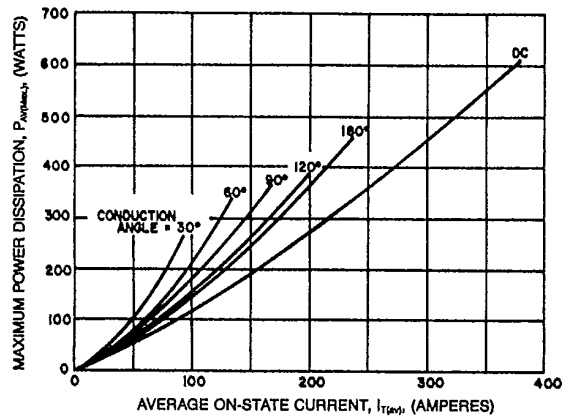

MAXIMUM ALLOWABLE CASE TEMPERATURE (RECTANGULAR WAVEFORM)

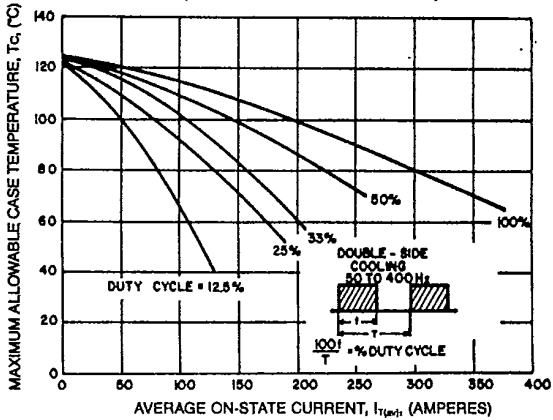

MAXIMUM ON-STATE POWER DISSIPATION (RECTANGULAR WAVEFORM)

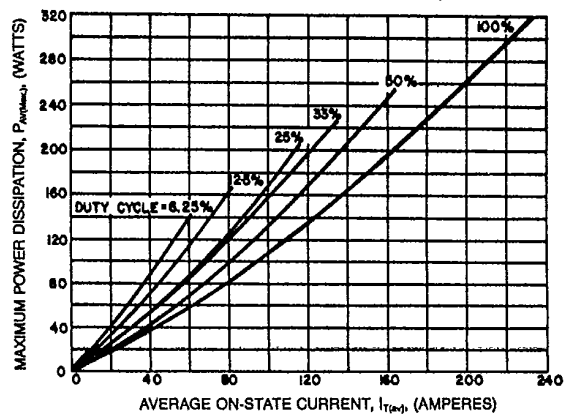



Powerex, Inc., Hillis Street, Youngwood, Pennsylvania 15697 (412) 925-7272
 Powerex Europe, S.A., 428 Ave. G. Durand, BP107, 72003 LeMans, France (43) 72.75.15

C380
 Phase Control SCR
 250 Amperes Avg/100-1300 Volts

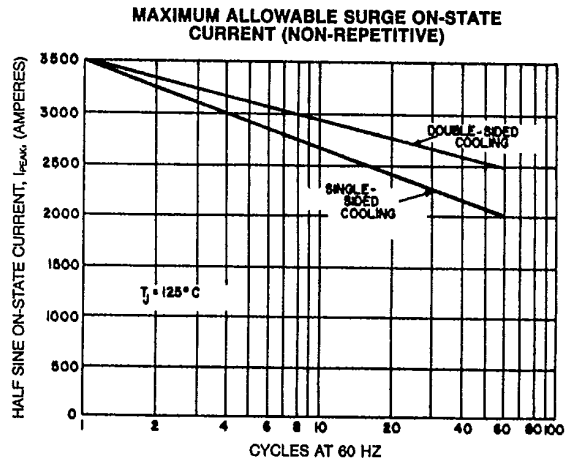
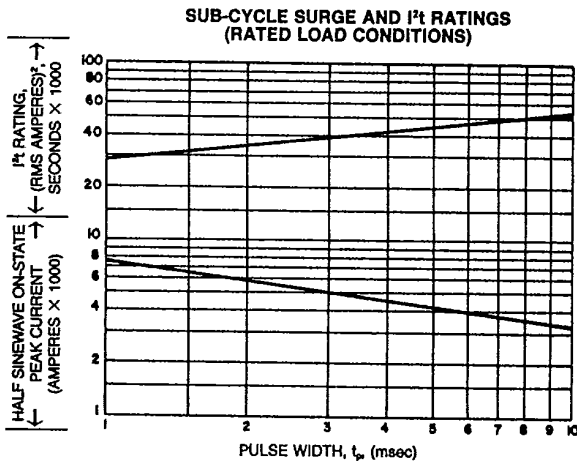
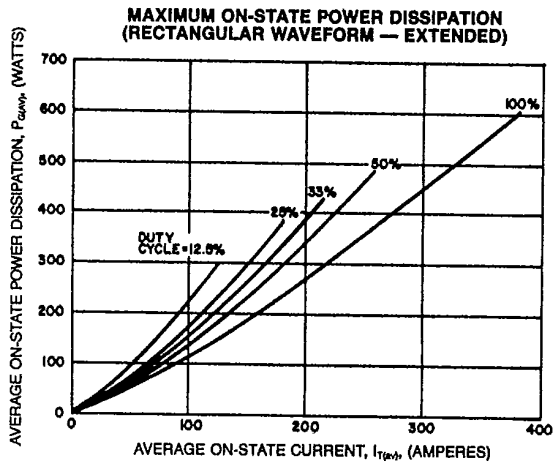
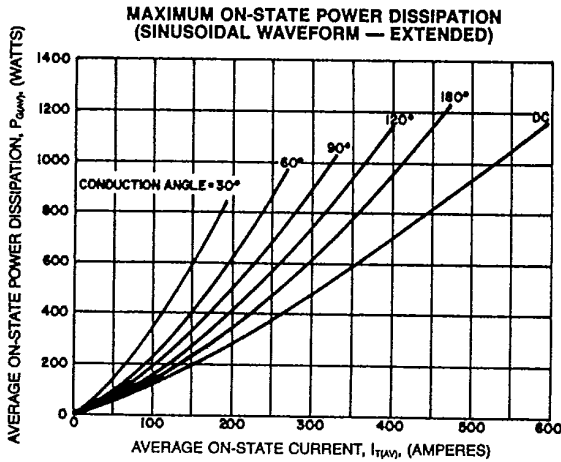
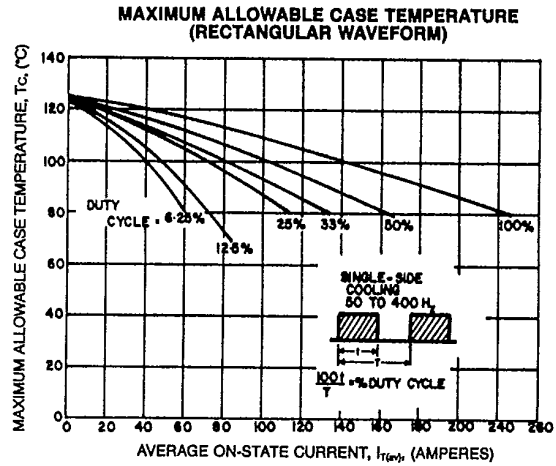
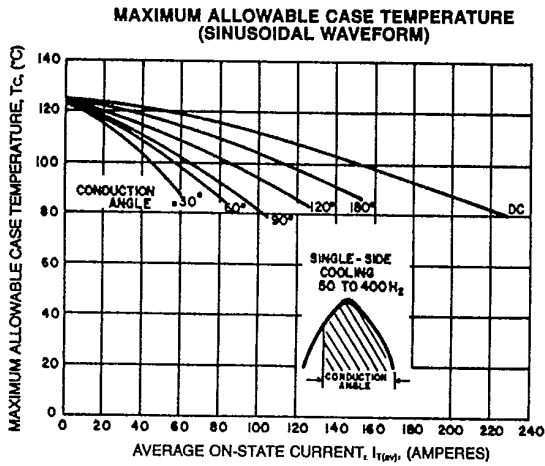



Powerex, Inc., Hillis Street, Youngwood, Pennsylvania 15697 (412) 925-7272
 Powerex Europe, S.A., 428 Ave. G. Durand, BP107, 72003 LeMans, France (43) 72.75.15

C380
 Phase Control SCR
 250 Amperes Avg/100-1300 Volts

MAXIMUM RECOVERED CHARGE

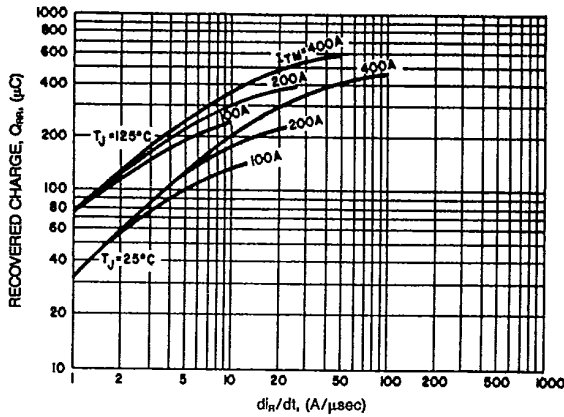

GATE CHARACTERISTICS

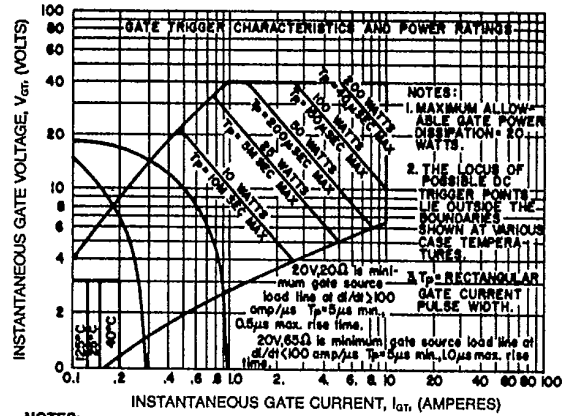

- NOTES:
1. Maximum allowable gate power dissipation = 20 watts.
 2. The locus of possible DC trigger points lie outside the boundaries shown at various case temperatures.
 3. T_p = Rectangular Gate Current Pulse Width.