

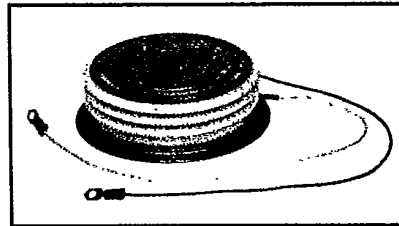

TA20

Powerex, Inc. Hillis Street, Youngwood, Pennsylvania 15697 (412) 925-7272
 Powerex Europe, S.A., 428 Ave. G. Durand, BP107, 72003 LeMans, France (43) 72.75.15

Phase Control SCR
 1600-1800 Amperes Avg
 100-2200 Volts

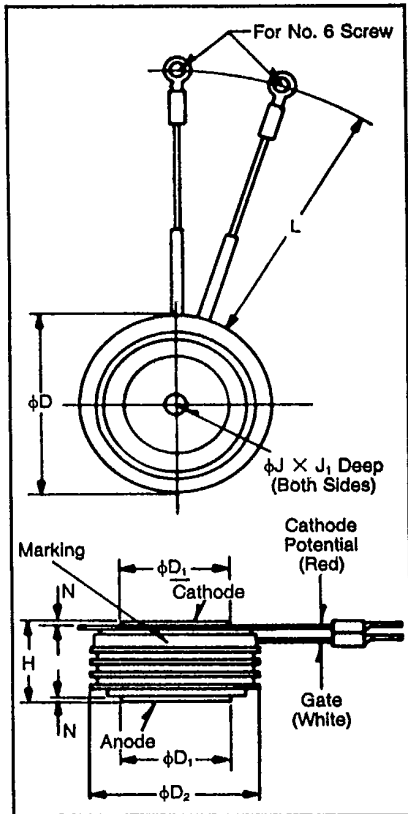

TA20
Phase Control SCR
 1600-1800 Amperes/100-2200 Volts

Description

Powerex Silicon Controlled Rectifiers (SCR) are designed for phase control applications. These are all-diffused, Press-Pak (Pow-R-Disc) devices employing the field-proven amplifying (di/namic) gate.

Features:

- Low On-State Voltage
- High di/dt
- High dv/dt
- Hermetic Packaging
- Excellent Surge and I²t Ratings

Applications:

- Power Supplies
- Battery Chargers
- Motor Control
- Light Dimmers
- VAR Generators

Ordering Information

Example: Select the complete eight digit part number you desire from the table - i.e. TA200816 is a 800 Volt, 1600 Ampere Phase Control SCR.

TA2
Outline Drawing

Dimensions	Inches		Millimeters	
	Min.	Max.	Min.	Max.
φD	3.910	3.950	99.31	100.33
φD ₁	2.470	2.480	62.74	63.00
φD ₂	3.440	3.560	87.38	90.42
H	1.260	1.300	32.00	33.02
φJ	.135	.145	3.43	3.68
J ₁	.075	.090	1.91	2.29
L	11.50	12.50	292.10	317.50
N	.050	—	1.27	—

Creep Distance—1.40 in. min. (35.56 mm)
 Strike Distance—.98 in. min. (24.89 mm).
 (In accordance with NEMA standards.)
 Finish—Nickel Plate.
 Approx. Weight—2.1 lb. (950 g).

1. Dimension "H" is a clamped dimension.

Type	Voltage*		Current	
	V _{ORM} V _{RRM}	Code	I _T (avg)	Code
TA20	100	01	1600	16
	200	02	1800	18
	400	04		
	600	06		
	800	08		
	1000	10		
	1200	12		
	1400	14		
	1600	16		
	1800	18		
	2000	20		
	2200	22		

* All voltages not available in all current ratings.



Powerex, Inc., Hillis Street, Youngwood, Pennsylvania 15697 (412) 925-7272

Powerex Europe, S.A., 428 Ave. G. Durand, BP107, 72003 LeMans, France (43) 72.75.15

TA20

Phase Control SCR

1600-1800 Amperes Avg/100-2200 Volts

Absolute Maximum Ratings

	Symbol	TA20 _ _ 16	TA20 _ _ 18	Units
Maximum Blocking Voltage	V_{DRM}, V_{RRM}	2200	1800	Volts
RMS On-State Current	$I_{T(RMS)}$	2500	2820	Amperes
Average On-State Current	$I_{T(av)}$	1600	1800	Amperes
Peak One-Cycle Surge (Non-Repetitive) On-State Current (60Hz) [ⓐ]	I_{TSM}	29,500	40,000	Amperes
Peak One-Cycle Surge (Non-Repetitive) On-State Current (50Hz) [ⓐ]	I_{TSM}	26,900	36,500	Amperes
Critical Rate-of-Rise of On-State Current (Non-Repetitive) ^{ⓐ ⓑ}	di/dt	400	400	Amperes/μs
Critical Rate-of-Rise of On-State Current (Repetitive)	di/dt	150	150	Amperes/μs
I ² t (for Fusing), One Cycle at 60 Hz	I ² t	3.63×10^6	6.67×10^6	A ² sec
Peak Gate Power Dissipation	P_{GM}	16	16	Watts
Average Gate Power Dissipation	$P_{G(av)}$	3	3	Watts
Storage Temperature	T_{STG}	-40 to 150	-40 to 150	°C
Operating Temperature	T_J	-40 to 125	-40 to 125	°C
Mounting Force [ⓐ]		9000 to 11,000	9000 to 11,000	lb.
Mounting Force [ⓐ]		4100 to 5000	4100 to 5000	kg

Electrical and Thermal Characteristics

	Symbol	Test Conditions	TA20 _ _ 16	TA20 _ _ 18	Units
Current—Conducting State Maximums					
Peak On-State Voltage	V_{TM}	$I_{TM} = 3000A, T_J = 25^\circ C$	1.75	1.45	Volts
TA20					
Voltage—Blocking State Maximums[ⓐ]					
Forward Leakage, Peak	I_{DRM}	$T_J = 125^\circ C, V_{DRM} = \text{rated}$	100		mA
Reverse Leakage, Peak	I_{RRM}	$T_J = 125^\circ C, V_{RRM} = \text{rated}$	100		mA
Switching					
Typical Turn-Off Time	t_q	$I_T = 250A, T_J = 125^\circ C,$ $di_R/dt = 50A/\mu\text{sec}, \text{reapplied}$ $dv/dt = 20V/\mu\text{sec linear to } 0.8V_{DRM}$	250		μsec
Typical Turn-On Time [ⓐ]	t_{on}	$I_{TM} = 1000A, V_D = 1500V$	4.0		μsec
Min. Critical dv/dt exponential to V_{DRM} ^{ⓐ ⓑ}	dv/dt	$T_J = 125^\circ C$	300		V/μsec
Thermal					
Maximum Thermal Resistance, [ⓐ] double sided cooling					
Junction to Case	$R_{\theta JC}$.015		°C/Watt
Case to Sink, Lubricated	$R_{\theta CS}$.007		°C/Watt
Gate—Maximum Parameters					
Gate Current to Trigger	I_{GT}	$T_J = 25^\circ C, V_D = 12V$	200		mA
Gate Voltage to Trigger	V_{GT}	$T_J = 25^\circ C, V_D = 12V$	3.0		Volts
Non-Triggering Gate Voltage	V_{GDM}	$T_J = 125^\circ C, \text{rated } V_{DRM}$.15		Volts
Peak Forward Gate Current	I_{GTM}		4		Amperes
Peak Reverse Gate Voltage	V_{GRM}		5		Volts

ⓐ Consult recommended mounting procedures.

ⓑ Applies for zero or negative gate bias.

ⓒ Per JEDEC RS-397, 5.2.2.1.

ⓓ With recommended gate drive.

ⓔ Higher dv/dt ratings available, consult factory.

ⓕ Per JEDEC standard RS-397, 5.2.2.6.



Powerex, Inc., Hillis Street, Youngwood, Pennsylvania 15697 (412) 925-7272
 Powerex Europe, S.A., 428 Ave. G. Durand, BP107, 72003 LeMans, France (43) 72.75.15

TA20
 Phase Control SCR
 1600-1800 Amperes Avg/100-2200 Volts

MAXIMUM ON-STATE CHARACTERISTICS

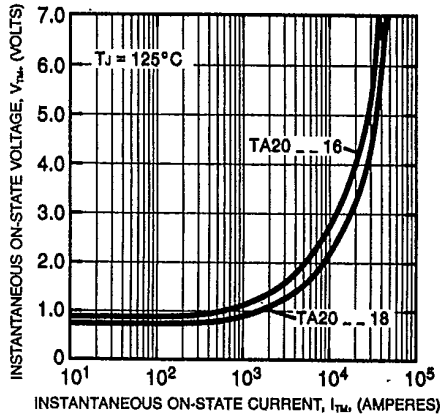

TRANSIENT THERMAL IMPEDANCE CHARACTERISTICS (JUNCTION TO CASE)

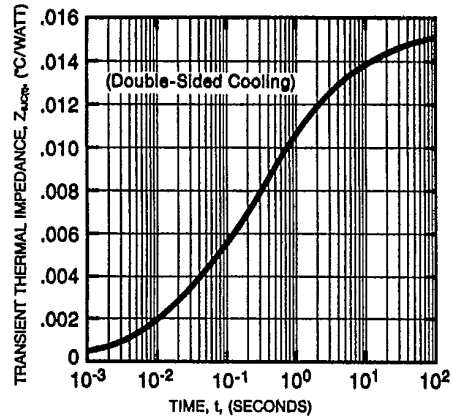

MAXIMUM ALLOWABLE CASE TEMPERATURE (SINUSOIDAL WAVEFORM)

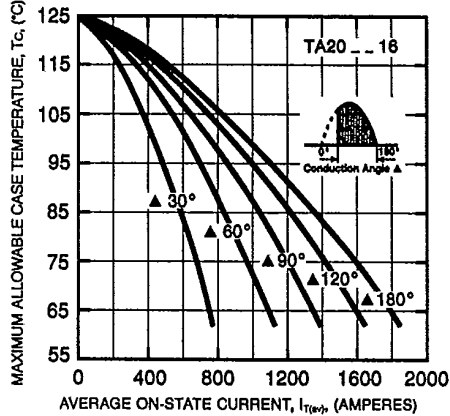

MAXIMUM ON-STATE POWER DISSIPATION (SINUSOIDAL WAVEFORM)

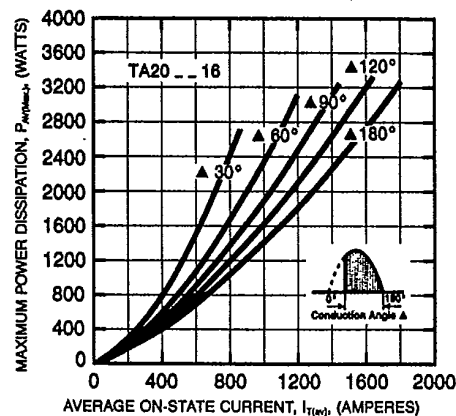

MAXIMUM ALLOWABLE CASE TEMPERATURE (RECTANGULAR WAVEFORM)

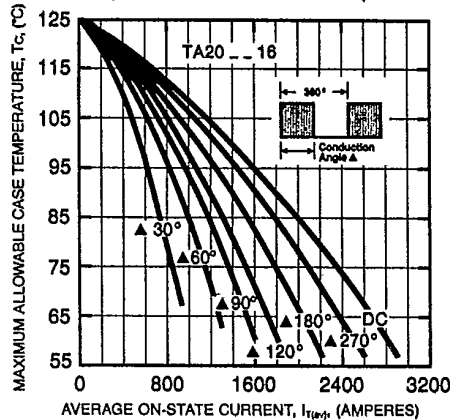

MAXIMUM ON-STATE POWER DISSIPATION (RECTANGULAR WAVEFORM)

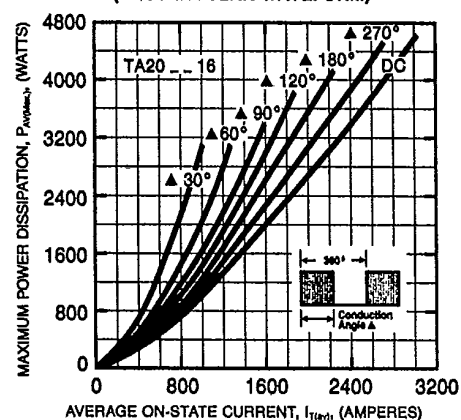



Powerex, Inc., Hillis Street, Youngwood, Pennsylvania 15697 (412) 925-7272
 Powerex Europe, S.A., 428 Ave. G. Durand, BP107, 72003 LeMans, France (43) 72.75.15

TA20
Phase Control SCR
 1600-1800 Amperes Avg/100-2200 Volts

