

**SURFACE MOUNT**

**GLASS PASSIVATED SILICON RECTIFIER**

**VOLTAGE RANGE 50 to 1000 Volts CURRENT 2.0 Amperes**

**FEATURES**

- \* Glass passivated device
- \* Ideal for surface mounted applications
- \* Low leakage current
- \* Metallurgically bonded construction
- \* Mounting position: Any
- \* Weight: 0.057 gram

**MECHANICAL DATA**

- \* Epoxy : Device has UL flammability classification 94V-0

**MAXIMUM RATINGS AND ELECTRICAL CHARACTERISTICS**

Ratings at 25 °C ambient temperature unless otherwise specified.  
 Single phase, half wave, 60 Hz, resistive or inductive load.  
 For capacitive load, derate current by 20%.



**DO-214AC**

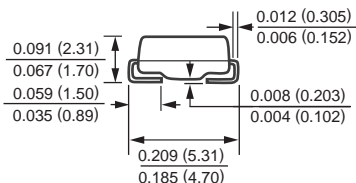
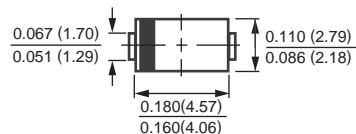

Dimensions in inches and (millimeters)

**MAXIMUM RATINGS** (At TA = 25°C unless otherwise noted)

RATINGS	SYMBOL	FM201A	FM202A	FM203A	FM204A	FM205A	FM206A	FM207A	UNITS
Maximum Recurrent Peak Reverse Voltage	VRRM	50	100	200	400	600	800	1000	Volts
Maximum RMS Voltage	VRMS	35	70	140	280	420	560	700	Volts
Maximum DC Blocking Voltage	VDC	50	100	200	400	600	800	1000	Volts
Maximum Average Forward Rectified Current at TA = 75°C	IO	2.0							Amps
Peak Forward Surge Current 8.3 ms single half sine-wave superimposed on rated load (JEDEC method)	IFSM	50							Amps
Typical Thermaesistance	(Note 2)RθJL	20							°C/W
	(Note 3)RθJA	50							°C/W
Typical Junction Capacitance (Note 1)	CJ	30							pF
Operating and Storage Temperature Range	TJ,TSTG	-55 to + 150							°C

**ELECTRICAL CHARACTERISTICS** (At TA = 25°C unless otherwise noted)

CHARACTERISTICS	SYMBOL	FM201A	FM202A	FM203A	FM204A	FM205A	FM206A	FM207A	UNITS	
Maximum Instantaneous Forward Voltage at 2.0A DC	VF					1.1				Volts
Maximum Average Reverse Current at Rated DC Blocking Voltage	@ TA = 25°C					5.0				uAmps
	@ TA = 125°C					125				uAmps

- NOTES : 1. Measured at 1 MHz and applied reverse voltage of 4.0 volts.  
 2. Thermal resistance junction to terminal, 5X5mm<sup>2</sup> copper pads to each terminal.  
 3. Thermal resistance junction to ambient, 5X5mm<sup>2</sup> copper pads to each terminal.

# RATING AND CHARACTERISTIC CURVES ( FM201A THRU FM207A )

FIG. 1 - TYPICAL FORWARD CURRENT DERATING CURVE

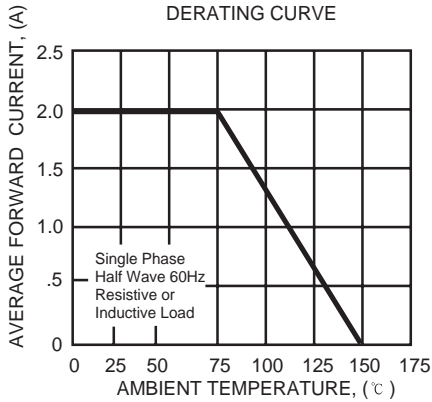

FIG. 2 - TYPICAL INSTANTANEOUS FORWARD CHARACTERISTICS

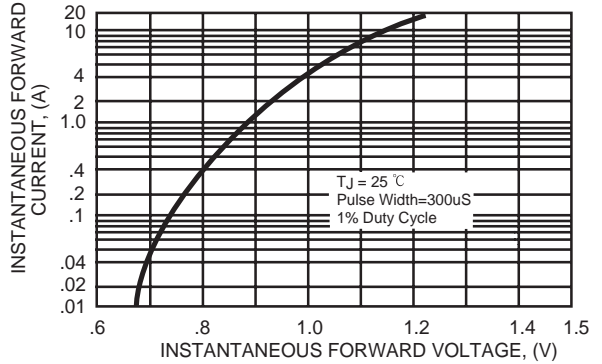

FIG. 3 - MAXIMUM NON-REPETITIVE FORWARD SURGE CURRENT

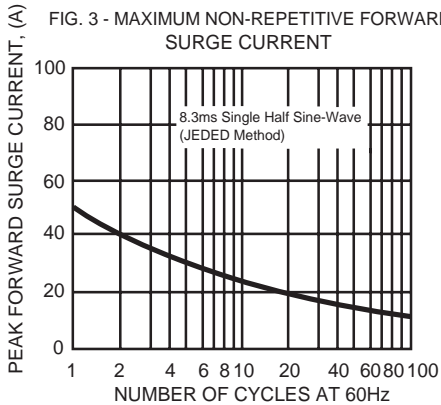

FIG. 4 - TYPICAL REVERSE CHARACTERISTICS

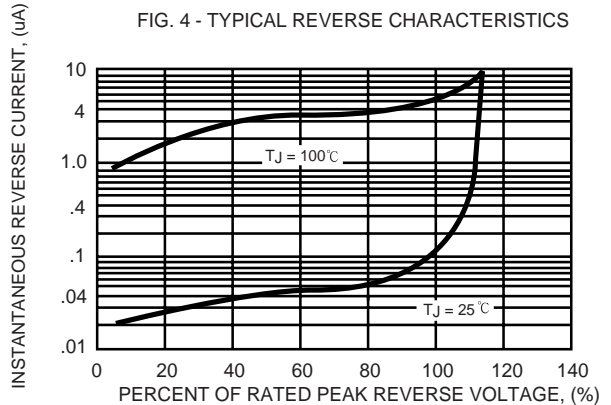
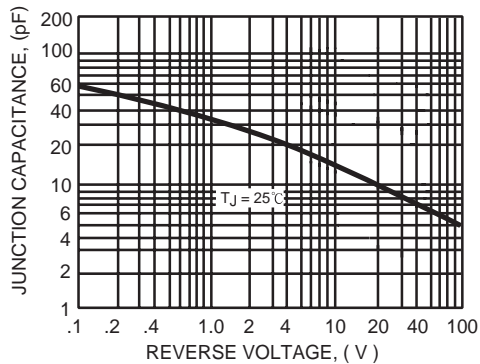
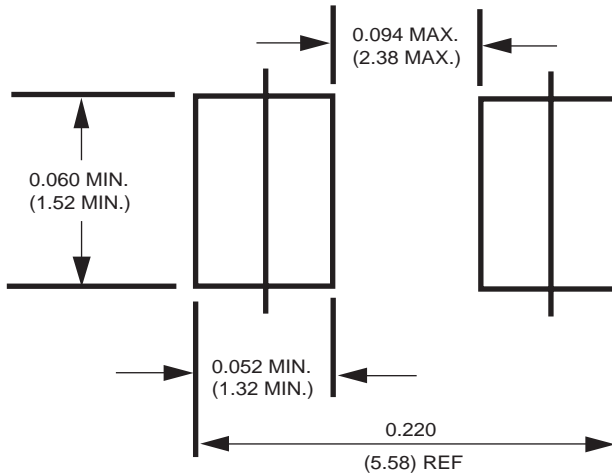

FIG. 5 - TYPICAL JUNCTION CAPACITANCE



## Mounting Pad Layout



Dimensions in inches and (millimeters)