

---

**LOW NOISE 150mA LDO  
REGULATOR  
R1112N SERIES**

**APPLICATION MANUAL**

### R1112N SERIES

#### OUTLINE

The R1112N Series are voltage regulator ICs with high output voltage accuracy, extremely low supply current, low ON-resistance, and high ripple rejection by CMOS process. Each of these voltage regulator ICs consists of a voltage reference unit, an error amplifier, resistors, a current limit circuit, and a chip enable circuit.

These ICs perform with low dropout voltage and a chip enable function. The line transient response and load transient response of the R1112N Series are excellent, thus these ICs are very suitable for the power supply for hand-held communication equipment.

The output voltage of these ICs is fixed with high accuracy. Since the package for these ICs are SOT-23-5 (Mini-mold) package, high density mounting of the ICs on boards is possible.

#### FEATURES

- Ultra-Low Supply Current ..... TYP. 100 $\mu$ A
- Standby Mode Current..... TYP. 0.1 $\mu$ A
- Low Dropout Voltage ..... TYP. 0.19V ( $I_{OUT}=100\text{mA}$  3.0V Output type)
- High Ripple Rejection ..... TYP. 80dB( $f=1\text{kHz}$ )
- Low Temperature-Drift Coefficient of Output Voltage TYP.  $\pm 100\text{ppm}/^{\circ}\text{C}$
- Excellent Line Regulation..... TYP. 0.05%/V
- High Output Voltage Accuracy .....  $\pm 2.0\%$
- Excellent Dynamic Response
- Small Package ..... SOT-23-5 (Mini-mold)
- Output Voltage..... Stepwise setting with a step of 0.1V in the range of 1.5V to 5.0V is possible
- Built-in chip enable circuit (2 types; A: active low, B: active high)
- Pin-out..... Similar to the LP2980/LP2985
- Built-in fold-back protection circuit..... TYP. 30mA (Current at short mode)
- Ceramic capacitors recommended to be used with this IC

#### APPLICATIONS

- Power source for cellular phones such as GSM, CDMA and various kind of PCSs.
- Power source for electrical appliances such as cameras, VCRs and camcorders.
- Power source for battery-powered equipment.

## BLOCK DIAGRAM

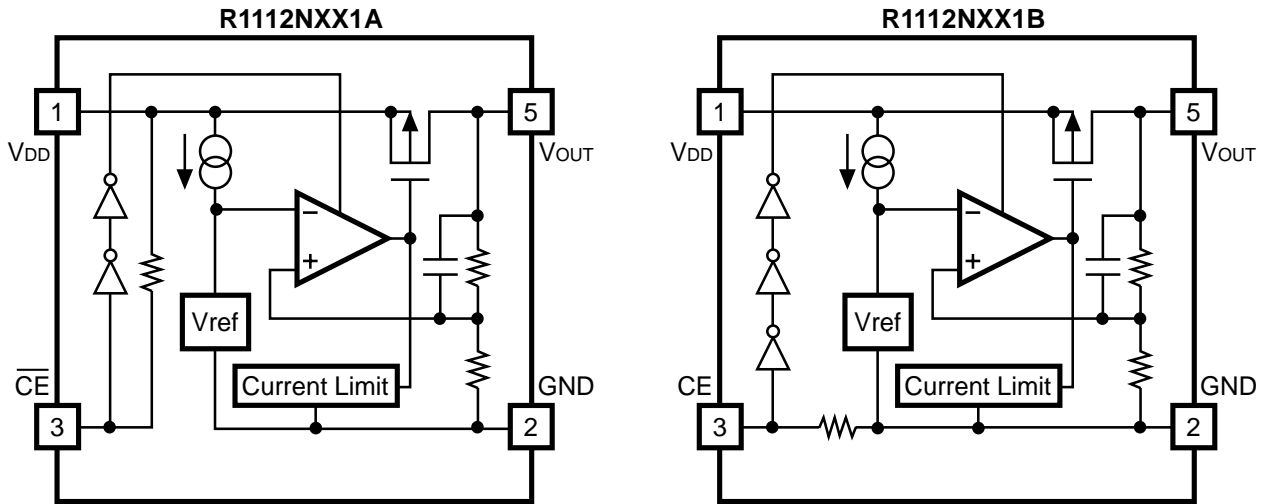

## SELECTION GUIDE

The output voltage, the active type, the packing type, and the taping type for the ICs can be selected at the user's request. The selection can be made by designating the part number as shown below:

R1112XXX1X-XX ←Part Number  
 ↑ ↑ ↑ ↑  
 a b c d

Code	Contents
a	Designation of Package Type: N: SOT-23-5 (Mini-mold)
b	Setting Output Voltage ( $V_{OUT}$ ): Stepwise setting with a step of 0.1V in the range of 1.5V to 5.0V is possible.
c	Designation of Active Type: A: active low type B: active high type
d	Designation of Taping Type: Ex. TR, TL (refer to Taping Specifications; TR type is the standard direction.)

## PIN CONFIGURATION

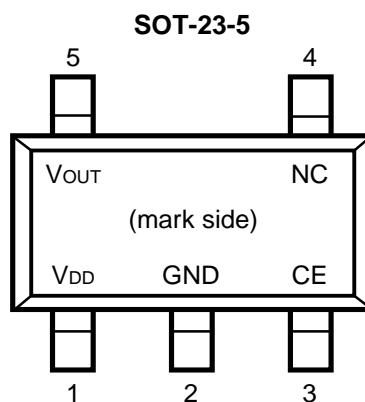

## PIN DESCRIPTION

Pin No.	Symbol	Description
1	V <sub>DD</sub>	Input Pin
2	GND	Ground Pin
3	$\overline{\text{CE}}$ or CE	Chip Enable Pin
4	NC	No Connection
5	V <sub>OUT</sub>	Output pin

## ABSOLUTE MAXIMUM RATINGS

Symbol	Item	Rating	Unit
V <sub>IN</sub>	Input Voltage	7.0	V
V <sub>CE</sub>	Input Voltage( $\overline{\text{CE}}$ or CE Pin)	-0.3 ~ V <sub>IN</sub> +0.3	V
V <sub>OUT</sub>	Output Voltage	-0.3 ~ V <sub>IN</sub> +0.3	V
I <sub>OUT</sub>	Output Current	200	mA
P <sub>D</sub>	Power Dissipation	250	mW
T <sub>opt</sub>	Operating Temperature Range	-40 ~ 85	°C
T <sub>stg</sub>	Storage Temperature Range	-55 ~ 125	°C

## ELECTRICAL CHARACTERISTICS

### • R1112NXX1A

T<sub>opt</sub>=25°C

Symbol	Item	Conditions	MIN.	TYP.	MAX.	Unit
V <sub>OUT</sub>	Output Voltage	V <sub>IN</sub> = Set V <sub>OUT</sub> +1V 1mA ≤ I <sub>OUT</sub> ≤ 30mA	V <sub>OUT</sub> ×0.98		V <sub>OUT</sub> ×1.02	V
I <sub>OUT</sub>	Output Current	V <sub>IN</sub> - V <sub>OUT</sub> = 1.0V	150			mA
ΔV <sub>OUT</sub> /ΔI <sub>OUT</sub>	Load Regulation	V <sub>IN</sub> = Set V <sub>OUT</sub> +1V 1mA ≤ I <sub>OUT</sub> ≤ 80mA		12	40	mV
V <sub>DIF</sub>	Dropout Voltage	Refer to the ELECTRICAL CHARACTERISTICS by OUTPUT VOLTAGE				
I <sub>SS</sub>	Supply Current	V <sub>IN</sub> = Set V <sub>OUT</sub> +1V		100	170	μA
I <sub>standby</sub>	Supply Current (Standby)	V <sub>IN</sub> = V <sub>CE</sub> = Set V <sub>OUT</sub> +1V		0.1	1.0	μA
ΔV <sub>OUT</sub> /ΔV <sub>IN</sub>	Line Regulation	Set V <sub>OUT</sub> +0.5V ≤ V <sub>IN</sub> ≤ 8V I <sub>OUT</sub> = 30mA		0.05	0.20	%/V
RR	Ripple Rejection	f = 1kHz, Ripple 0.5Vp-p V <sub>IN</sub> = Set V <sub>OUT</sub> +1V		80		dB
V <sub>IN</sub>	Input Voltage		2.0		6.0	V
ΔV <sub>OUT</sub> /ΔT	Output Voltage Temperature Coefficient	I <sub>OUT</sub> = 30mA -40°C ≤ T <sub>opt</sub> ≤ 85°C		±100		ppm /°C
I <sub>lim</sub>	Short Current Limit	V <sub>OUT</sub> = 0V		30		mA
R <sub>PU</sub>	$\overline{\text{CE}}$ Pull-up Resistance		2.5	5	10	MΩ
V <sub>CEH</sub>	$\overline{\text{CE}}$ Input Voltage "H"		1.5		V <sub>IN</sub>	V
V <sub>CEL</sub>	$\overline{\text{CE}}$ Input Voltage "L"		0		0.25	V
e <sub>n</sub>	Output Noise	BW = 10Hz to 100kHz		30		μVrms

## • R1112NXX1B

Topt=25°C

Symbol	Item	Conditions	MIN.	TYP.	MAX.	Unit
V <sub>OUT</sub>	Output Voltage	V <sub>IN</sub> = Set V <sub>OUT</sub> +1V 1mA ≤ I <sub>OUT</sub> ≤ 30mA	V <sub>OUT</sub> ×0.98		V <sub>OUT</sub> ×1.02	V
I <sub>OUT</sub>	Output Current	V <sub>IN</sub> - V <sub>OUT</sub> = 1.0V	150			mA
ΔV <sub>OUT</sub> /ΔI <sub>OUT</sub>	Load Regulation	V <sub>IN</sub> = Set V <sub>OUT</sub> +1V 1mA ≤ I <sub>OUT</sub> ≤ 80mA		12	40	mV
V <sub>DIF</sub>	Dropout Voltage	Refer to the ELECTRICAL CHARACTERISTICS by OUTPUT VOLTAGE				
I <sub>SS</sub>	Supply Current	V <sub>IN</sub> = Set V <sub>OUT</sub> +1V		100	170	μA
I <sub>standby</sub>	Supply Current (Standby)	V <sub>IN</sub> = Set V <sub>OUT</sub> +1V V <sub>CE</sub> =GND		0.1	1.0	μA
ΔV <sub>OUT</sub> /ΔV <sub>IN</sub>	Line Regulation	Set V <sub>OUT</sub> +0.5V ≤ V <sub>IN</sub> ≤ 8V I <sub>OUT</sub> = 30mA		0.05	0.20	%/V
RR	Ripple Rejection	f = 1kHz, Ripple 0.5Vp-p V <sub>IN</sub> = Set V <sub>OUT</sub> +1V		80		dB
V <sub>IN</sub>	Input Voltage		2.0		6.0	V
ΔV <sub>OUT</sub> /ΔT	Output Voltage Temperature Coefficient	I <sub>OUT</sub> = 30mA -40°C ≤ Top t ≤ 85°C		±100		ppm /°C
I <sub>lim</sub>	Short Current Limit	V <sub>OUT</sub> = 0V		30		mA
R <sub>PD</sub>	CE Pull-down Resistance		2.5	5	10	MΩ
V <sub>CEH</sub>	CE Input Voltage "H"		1.5		V <sub>IN</sub>	V
V <sub>CEL</sub>	CE Input Voltage "L"		0		0.25	V
e <sub>n</sub>	Output Noise	BW=10Hz to 100kHz		30		μVrms

## • ELECTRICAL CHARACTERISTICS by OUTPUT VOLTAGE

Topt = 25°C

Output Voltage V <sub>OUT</sub> (V)	Dropout Voltage		
	V <sub>DIF</sub> (V)		
	Condition	TYP.	MAX.
1.5 ≤ V <sub>OUT</sub> ≤ 1.6	I <sub>OUT</sub> = 100mA	0.32	0.55
1.7 ≤ V <sub>OUT</sub> ≤ 1.8		0.28	0.47
1.9 ≤ V <sub>OUT</sub> ≤ 2.3		0.25	0.35
2.4 ≤ V <sub>OUT</sub> ≤ 2.7		0.20	0.29
2.8 ≤ V <sub>OUT</sub> ≤ 5.0		0.19	0.26

## OPERATION

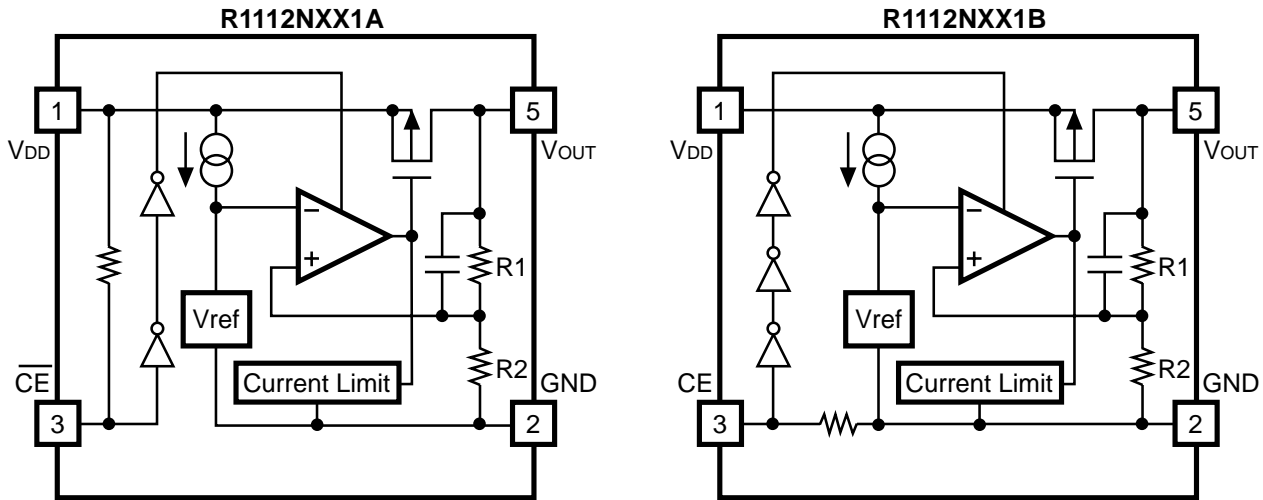

In these ICs, fluctuation of Output Voltage,  $V_{OUT}$  is detected by Feed-back Registers R1, R2, and the result is compared with a reference voltage by Error Amplifier, so that a constant voltage is output. A current limit circuit for protection at short mode and a chip enable circuit are included.

## TECHNICAL NOTES

When using these ICs, consider the following points:

### Phase Compensation

In these ICs, phase compensation is made for securing stable operation even if the load current is varied. For this purpose, be sure to use a capacitor  $C_{OUT}$  with good frequency characteristics and ESR (Equivalent Series Resistance). We use Ceramic Capacitors for evaluation of these ICs.

Recommended Capacitors; GRM40X5R225K6.3 (Murata)

GRM40-034X5R335K6.3 (Murata)

GRM40-034X5R475K6.3 (Murata)

(Note: When the additional ceramic capacitors are connected to the Output Pin with Output capacitor for phase compensation, the operation might be unstable. Because of this, test these ICs with as same external components as ones to be used on the PCB.)

### PCB Layout

Make  $V_{DD}$  and GND line sufficient. When the impedance of these is high, it would be a cause of picking up the noise or unstable operation. Connect a capacitor with a capacitance value of  $2.2\mu\text{F}$  or more between  $V_{DD}$  and GND pin as close as possible.

Set external components, especially output capacitor as close as possible to the ICs and make wiring shortest.

## TEST CIRCUITS

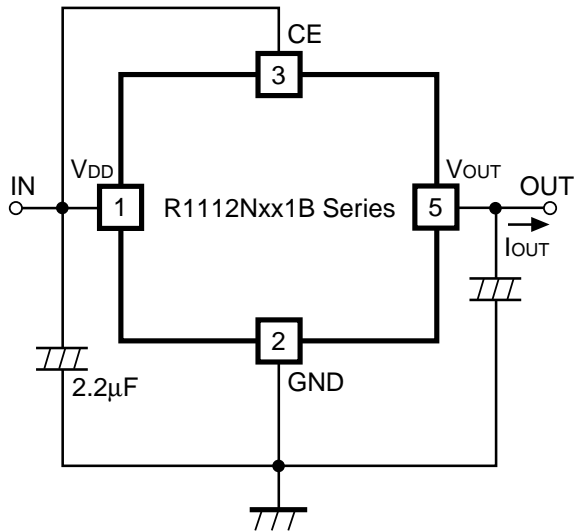

Fig.1 Standard test Circuit

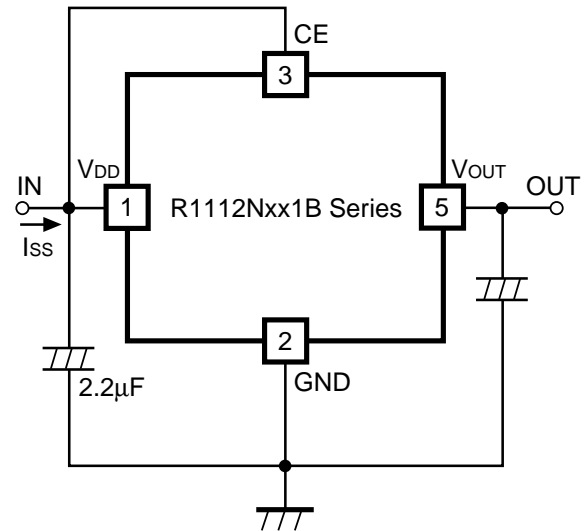

Fig.2 Supply Current Test Circuit

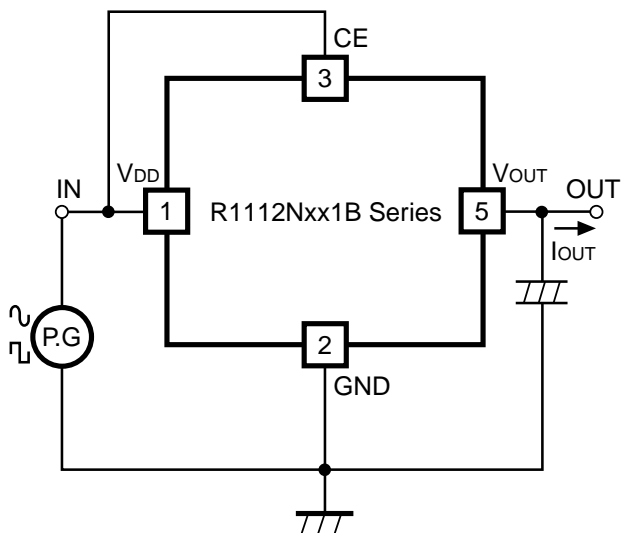

Fig.3 Ripple Rejection, Line Transient Response Test Circuit

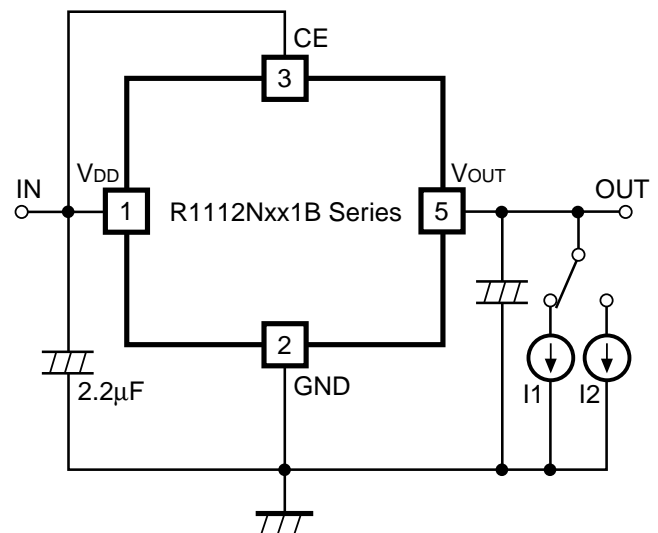
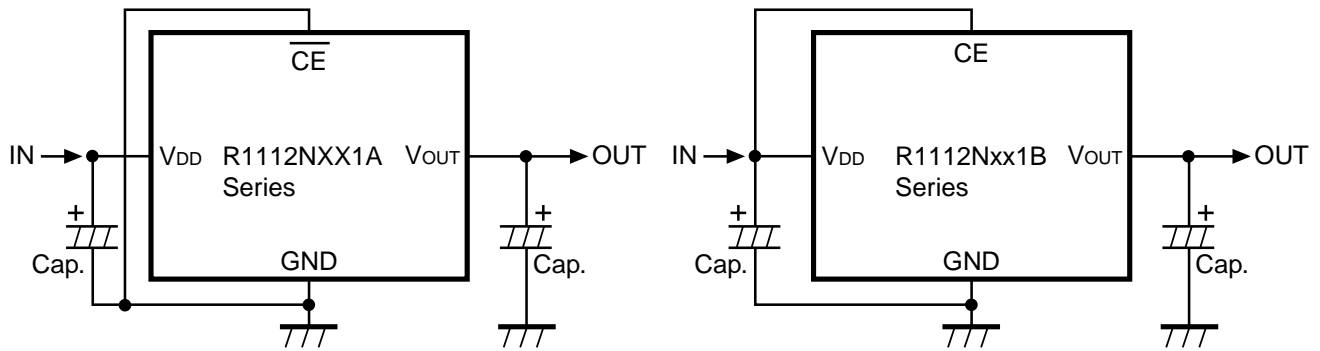

Fig.4 Load Transient Response Test Circuit



## TYPICAL APPLICATION



(External Components)

Output Capacitor; Ceramic 2.2 $\mu$ F (Set Output Voltage in the range from 2.5 to 5.0V)

Ceramic 4.7 $\mu$ F (Set Output Voltage in the range from 1.5 to 2.5V)

Input Capacitor; Ceramic 2.2 $\mu$ F

# TYPICAL CHARACTERISTICS

## 1) Output Voltage vs. Output Current

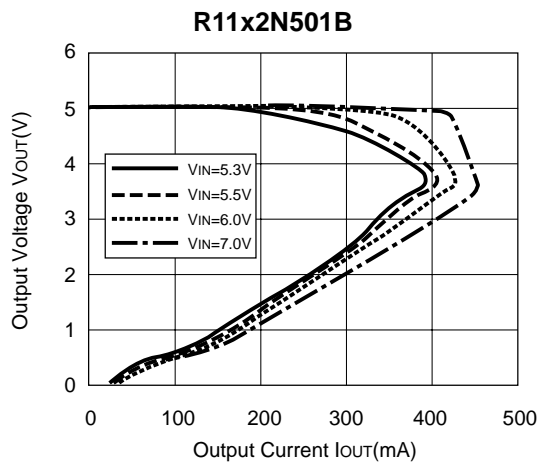
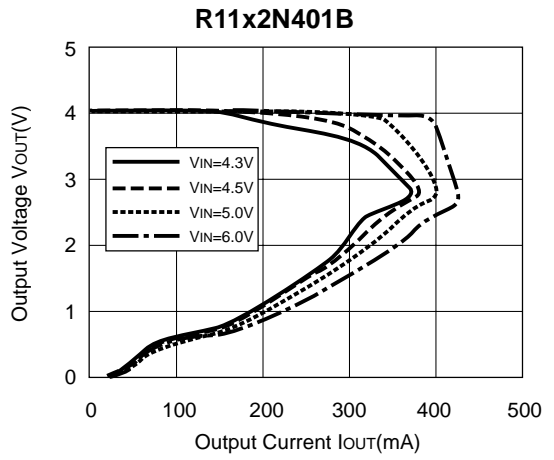
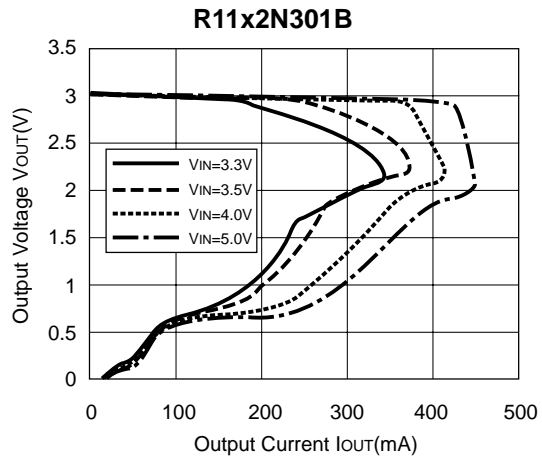
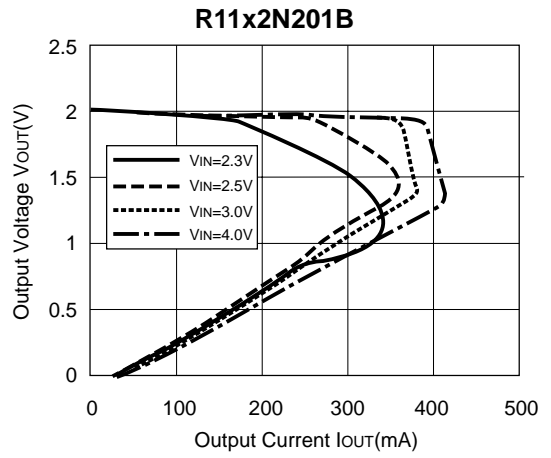
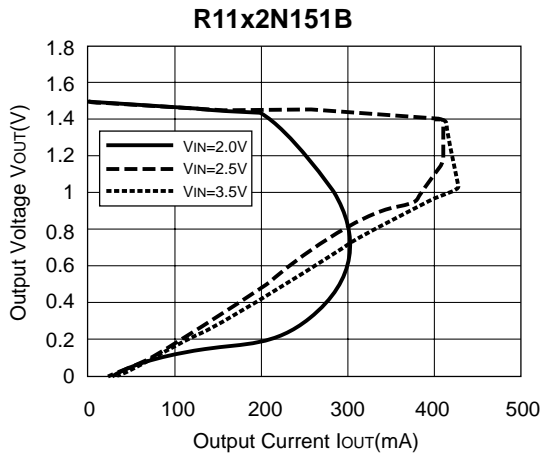

2) Output Voltage vs. Input Voltage

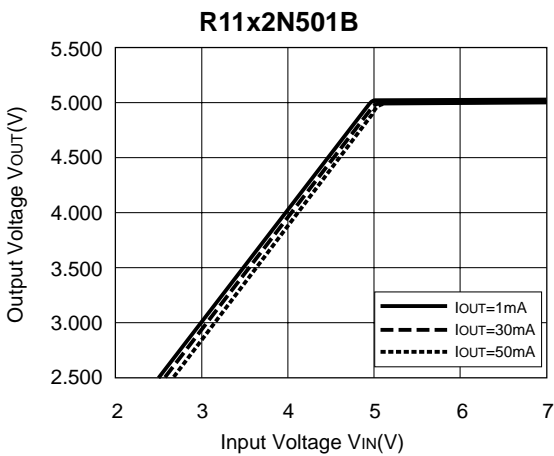
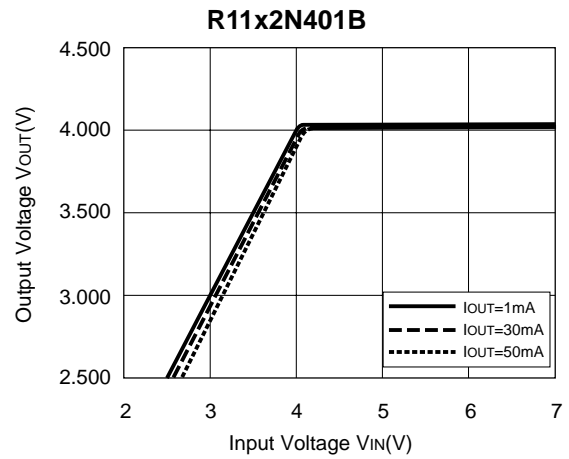
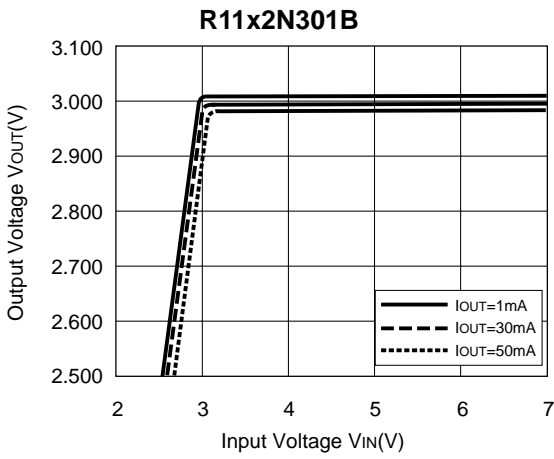
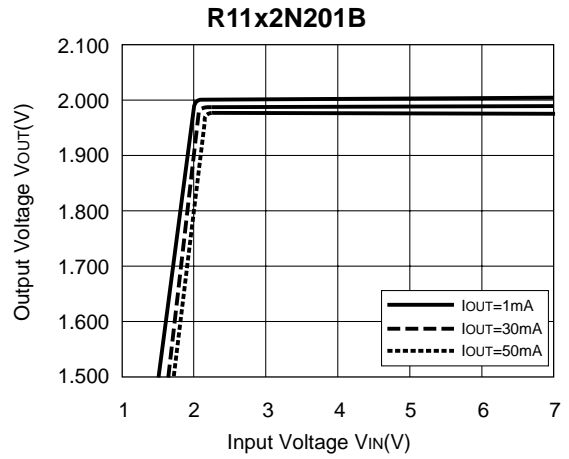
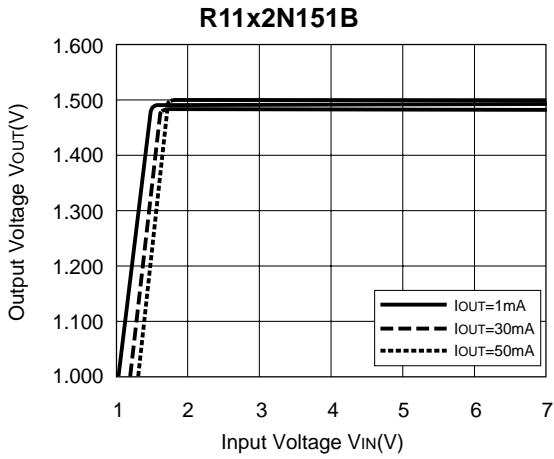

3) Dropout Voltage vs. Output Current

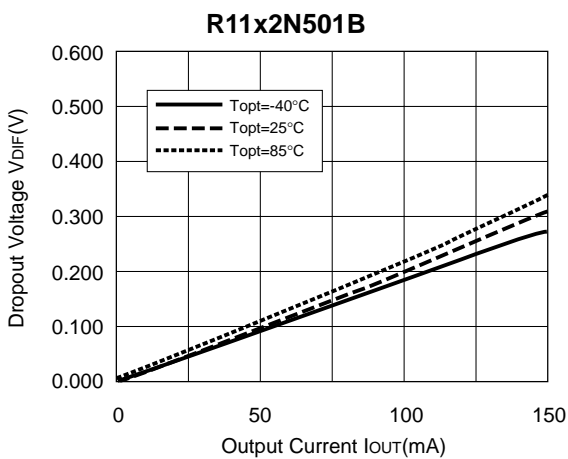
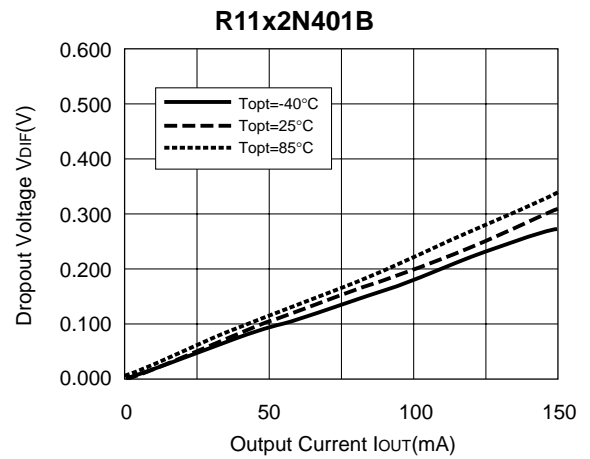
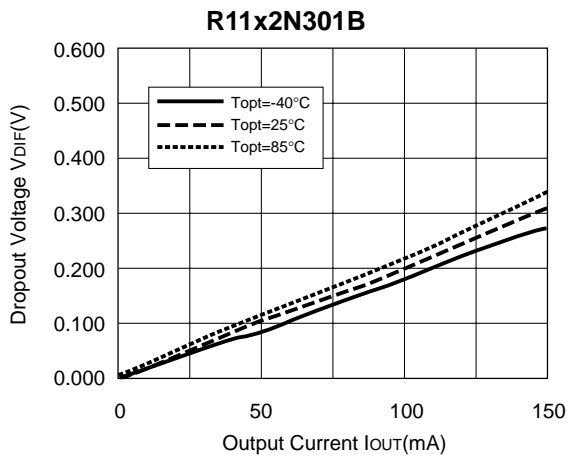
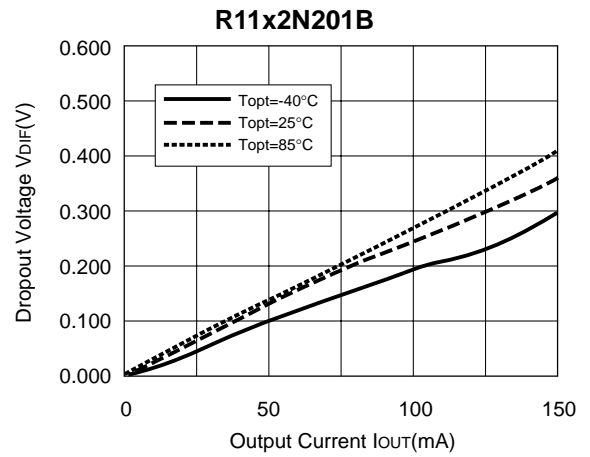
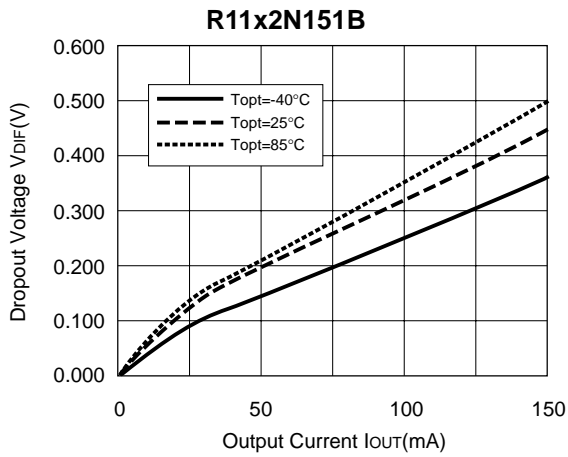

4) Output Voltage vs. Temperature

**R11x2N151A/B**

$V_{IN}=2.5V$   $C_{IN}=1\mu F$   
 $C_{OUT}=2.2\mu F$   $I_{OUT}=30mA$

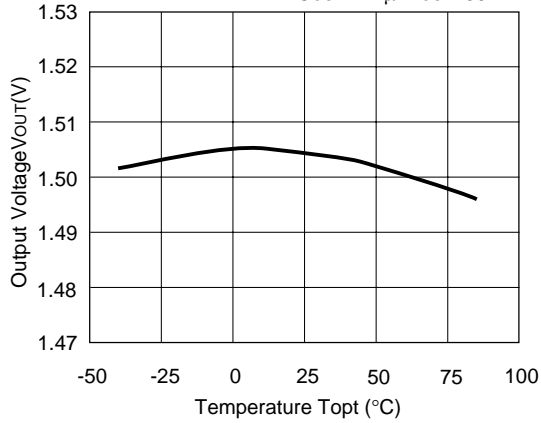

**R11x2N201B**

$V_{IN}=3.0V$   $C_{IN}=1\mu F$   
 $C_{OUT}=2.2\mu F$   $I_{OUT}=30mA$

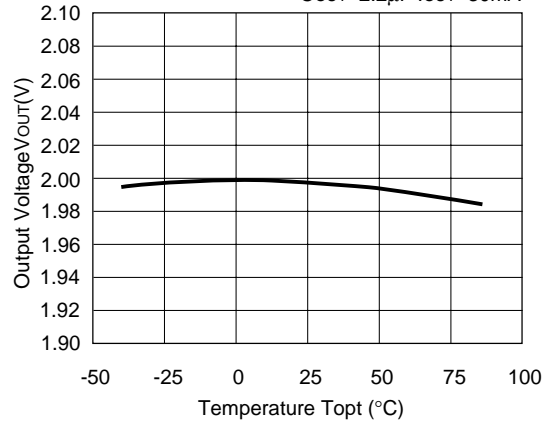

**R11x2N301A/B**

$V_{IN}=4.0V$   $C_{IN}=1\mu F$   
 $C_{OUT}=2.2\mu F$   $I_{OUT}=30mA$

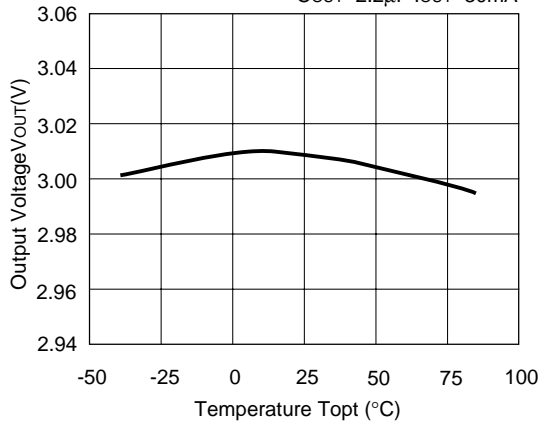

**R11x2N401A/B**

$V_{IN}=5.0V$   $C_{IN}=1\mu F$   
 $C_{OUT}=2.2\mu F$   $I_{OUT}=30mA$

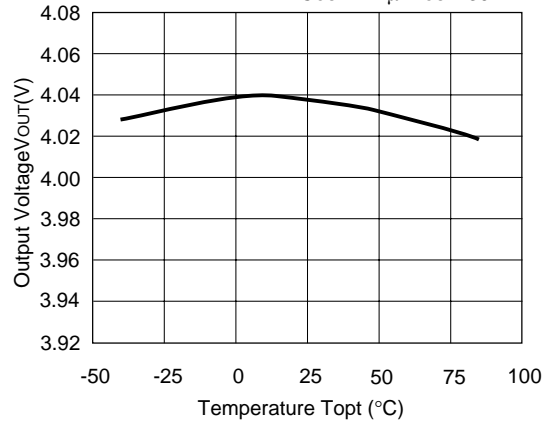

**R11x2N501A/B**

$V_{IN}=6.0V$   $C_{IN}=1\mu F$   
 $C_{OUT}=2.2\mu F$   $I_{OUT}=30mA$

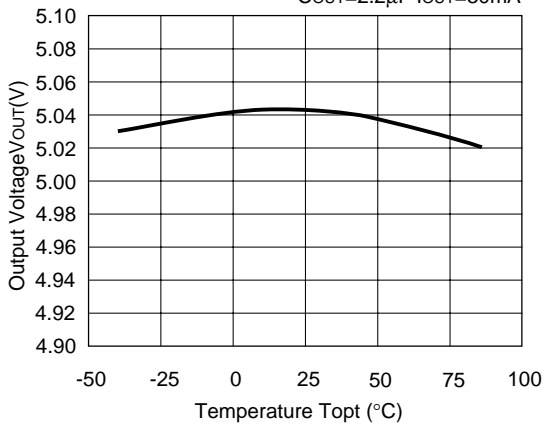

5) Supply Current vs. Input Voltage

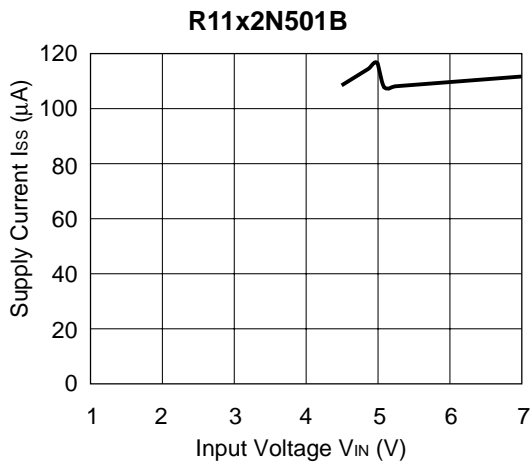
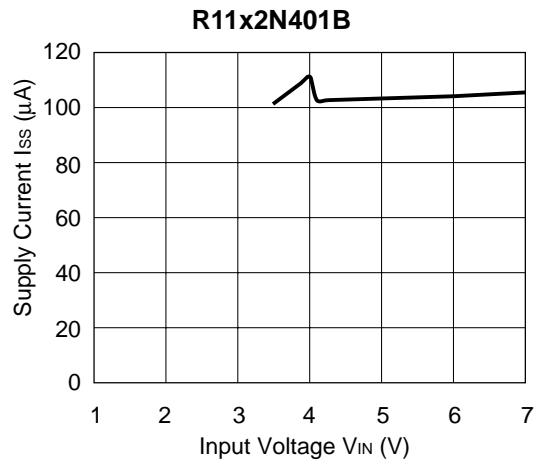
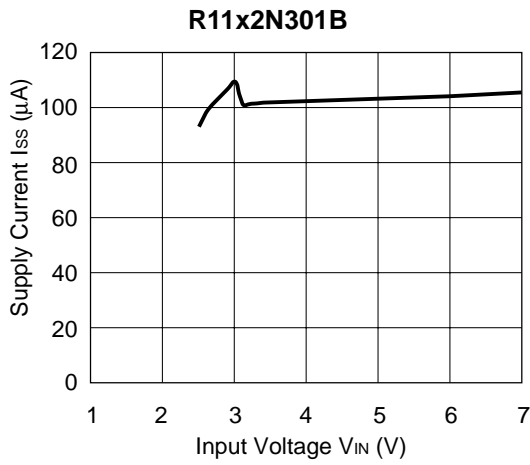
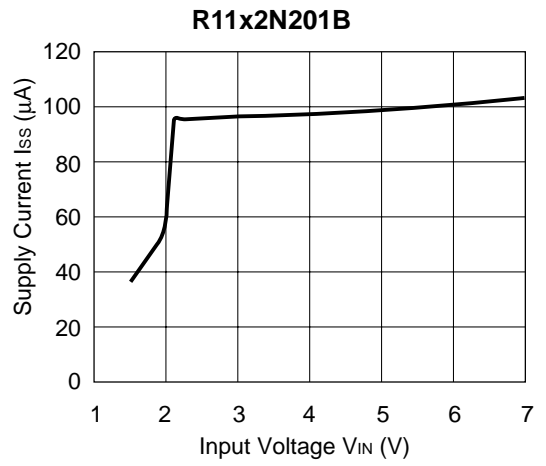
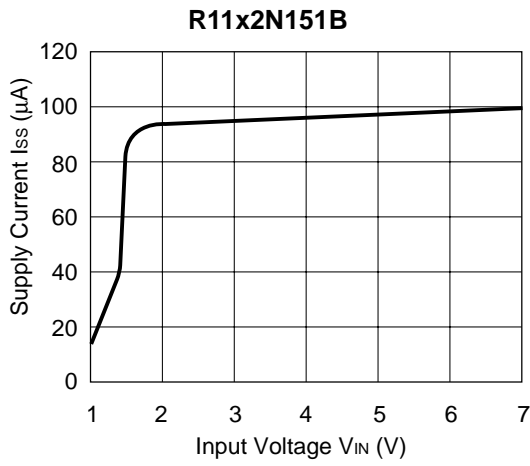

6) Supply Current vs. Temperature

**R11x2N151A/B**

$V_{IN}=2.5V$   $C_{IN}=1\mu F$   
 $C_{OUT}=2.2\mu F$

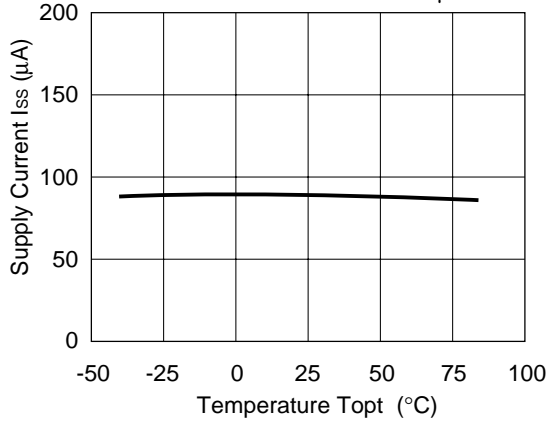

**R11x2N201A/B**

$V_{IN}=3.0V$   $C_{IN}=1\mu F$   
 $C_{OUT}=2.2\mu F$

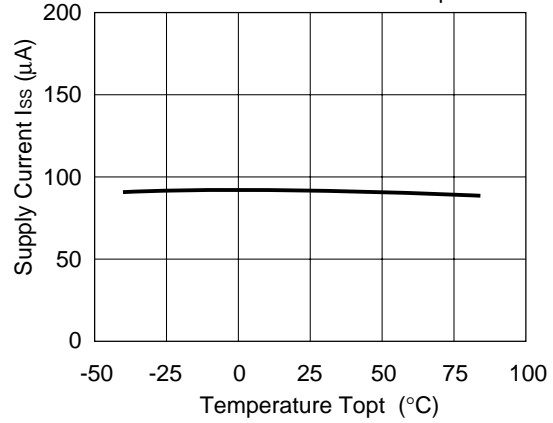

**R11x2N301A/B**

$V_{IN}=4.0V$   $C_{IN}=1\mu F$   
 $C_{OUT}=2.2\mu F$

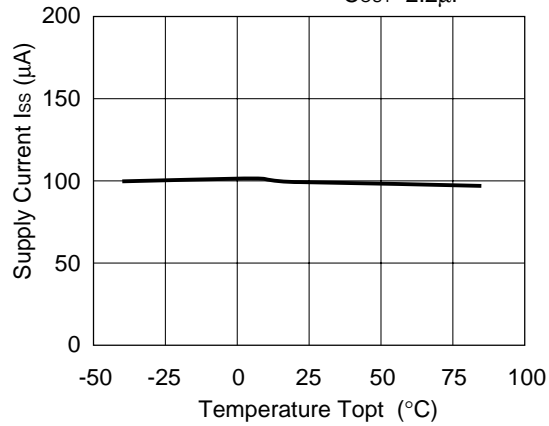

**R11x2N401A/B**

$V_{IN}=5.0V$   $C_{IN}=1\mu F$   
 $C_{OUT}=2.2\mu F$

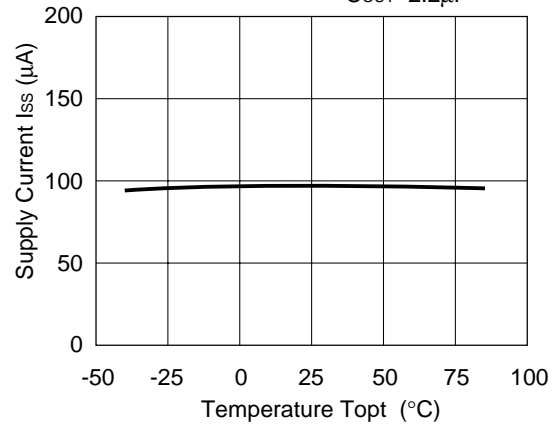

**R11x2N501A/B**

$V_{IN}=6.0V$   $C_{IN}=1\mu F$   
 $C_{OUT}=2.2\mu F$

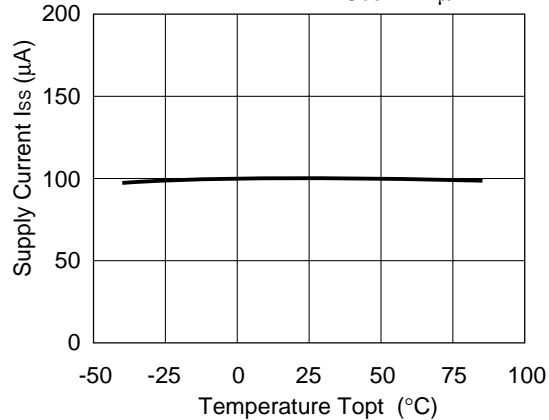

7) Ripple Rejection vs. Frequency

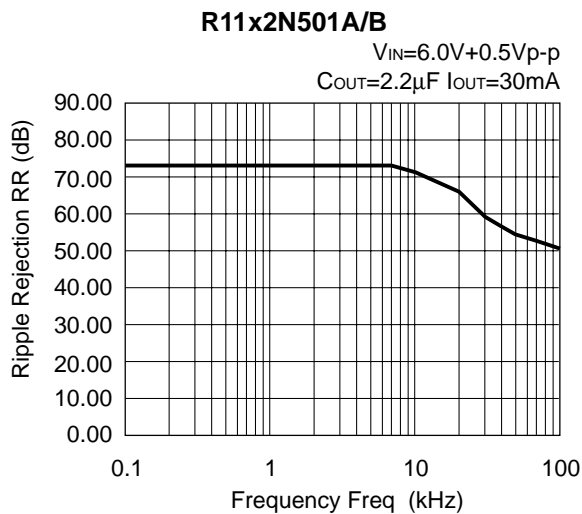
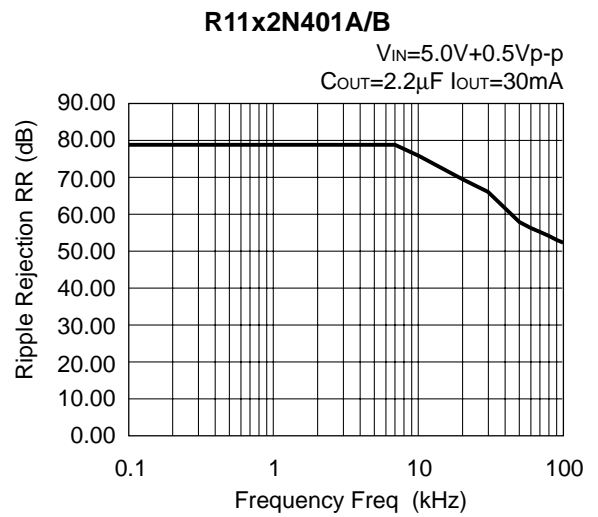
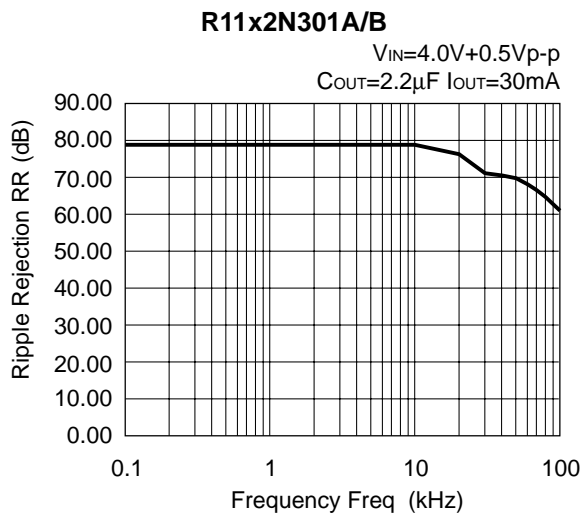
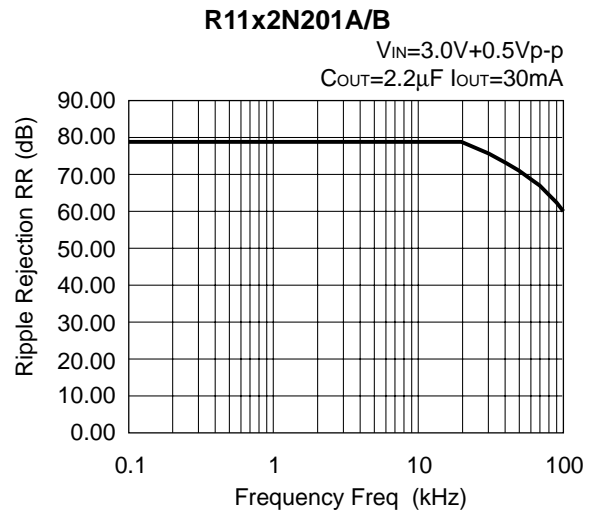
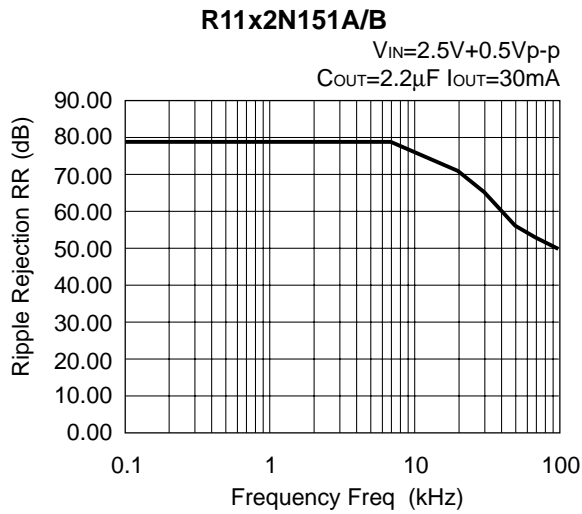



8) Ripple Rejection vs. Input Voltage (DC bias)

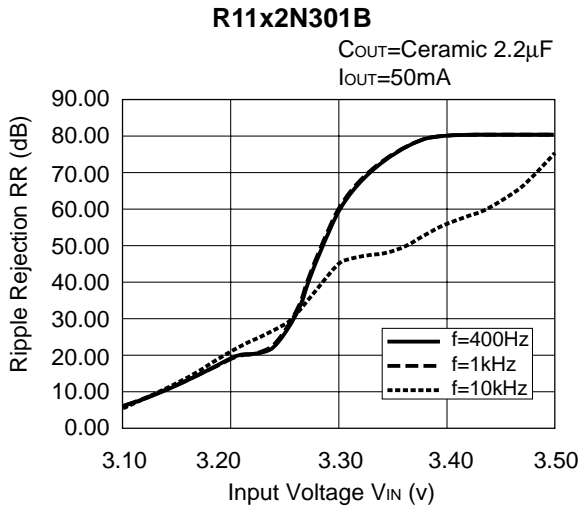
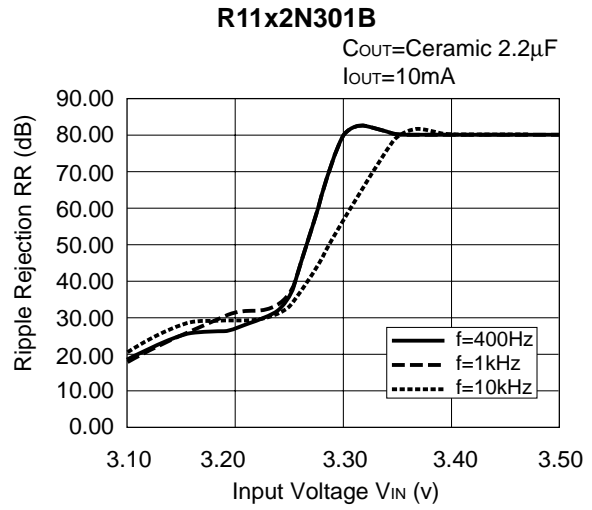
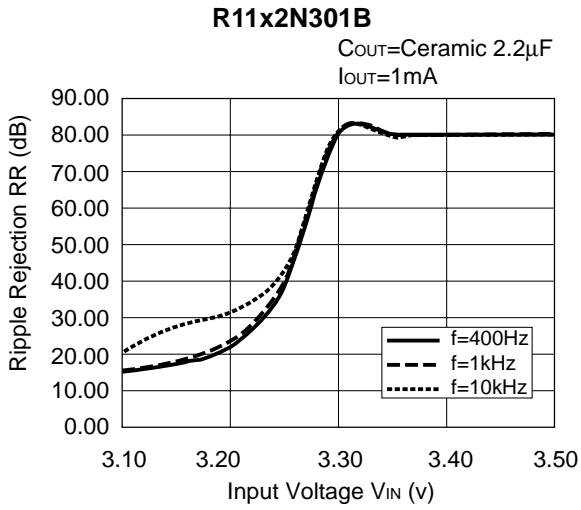

9) Input Transient Response

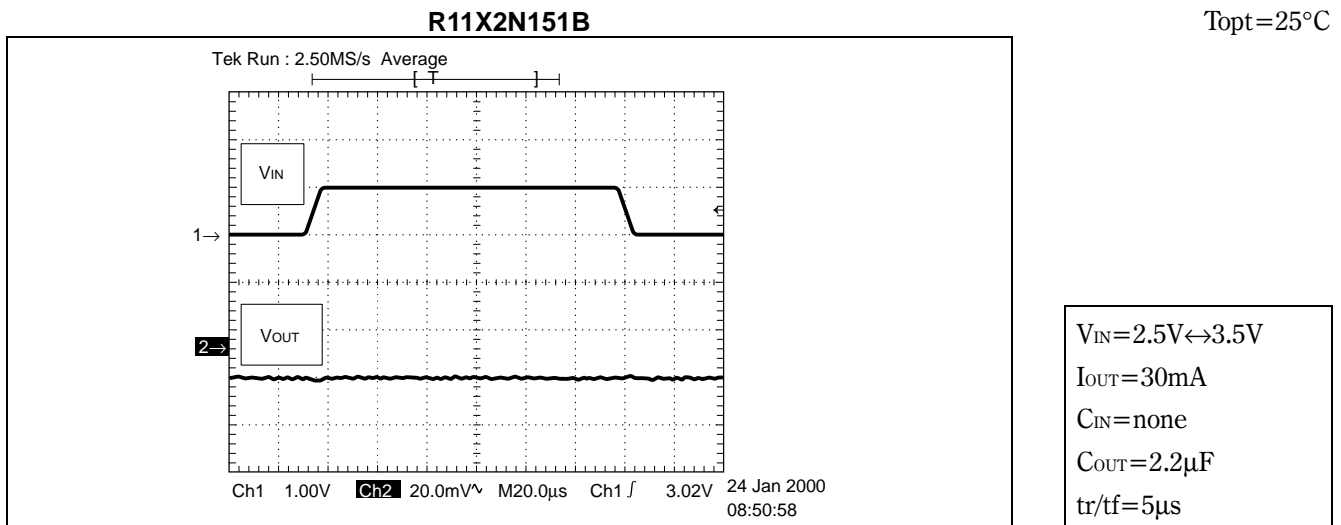

## R11X2N201B

Topt=25°C

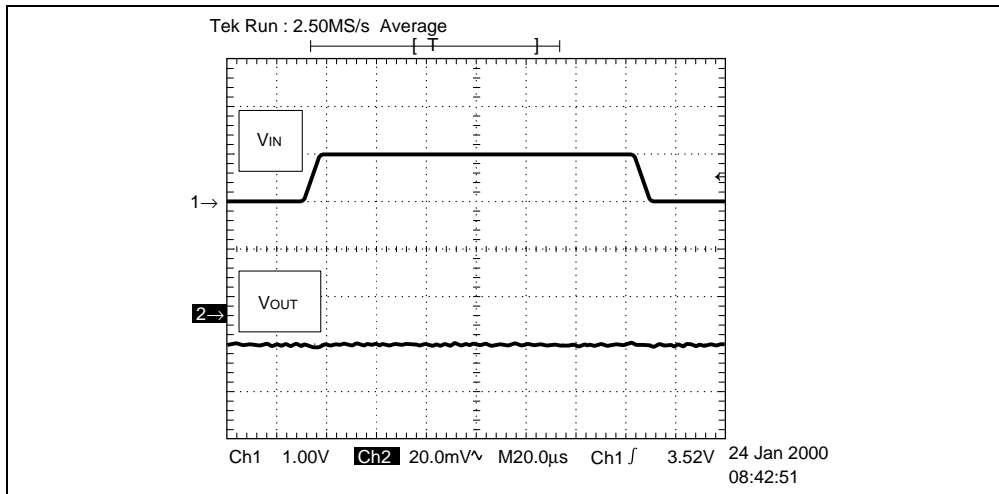
 $V_{IN}=3.0V \leftrightarrow 4.0V$  $I_{OUT}=30mA$  $C_{IN}=\text{none}$  $C_{OUT}=2.2\mu F$  $t_r/t_f=5\mu s$ 

## R11X2N301B

Topt=25°C

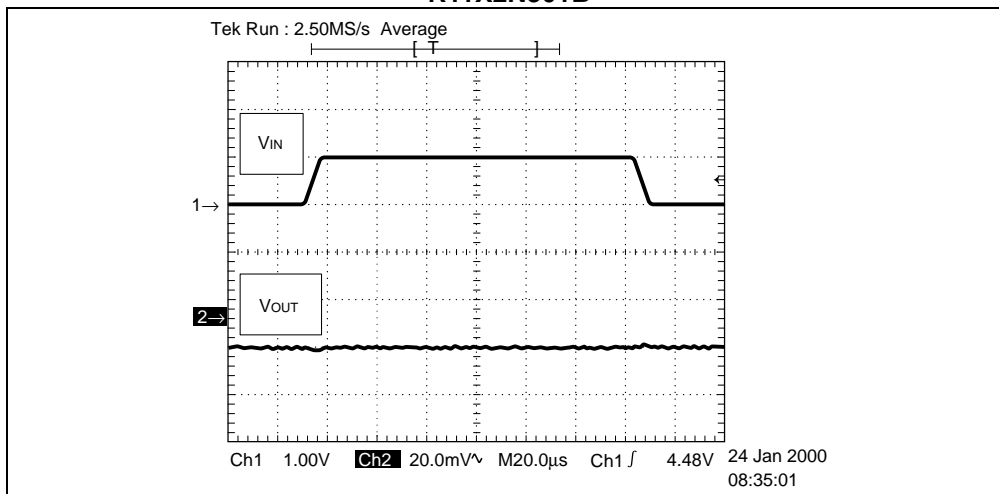
 $V_{IN}=4.0V \leftrightarrow 5.0V$  $I_{OUT}=30mA$  $C_{IN}=\text{none}$  $C_{OUT}=2.2\mu F$  $t_r/t_f=5\mu s$ 

## R11X2N401B

Topt=25°C

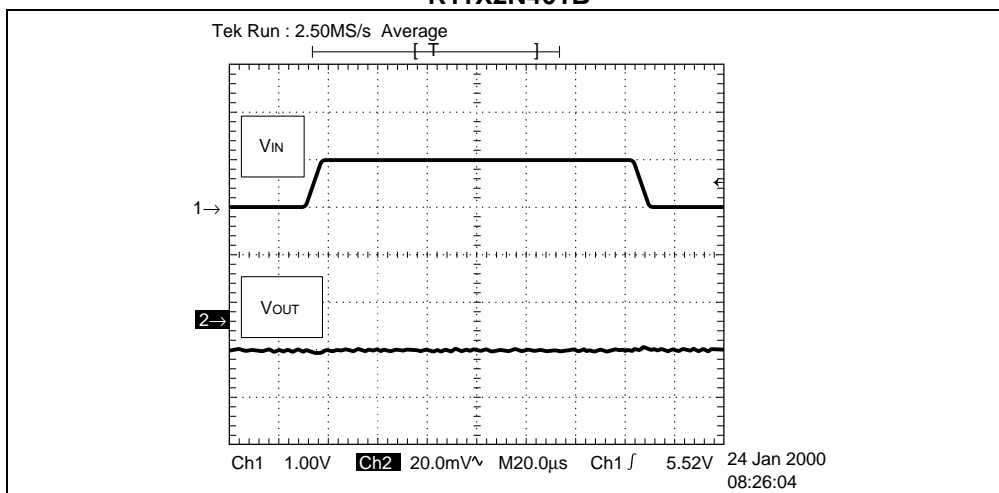
 $V_{IN}=5.0V \leftrightarrow 6.0V$  $I_{OUT}=30mA$  $C_{IN}=\text{none}$  $C_{OUT}=2.2\mu F$  $t_r/t_f=5\mu s$

**R11X2N501B**

$T_{opt}=25^{\circ}C$

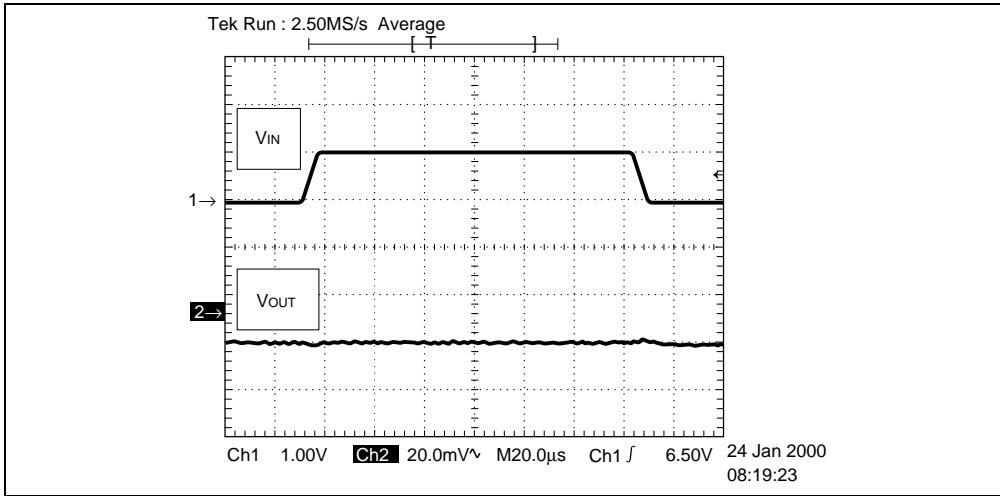

$V_{IN}=6.0V \leftrightarrow 7.0V$   
 $I_{OUT}=30mA$   
 $C_{IN}=none$   
 $C_{OUT}=2.2\mu F$   
 $t_r/t_f=5\mu s$

10) Load Transient Response

**R11X2N151B**

$T_{opt}=25^{\circ}C$

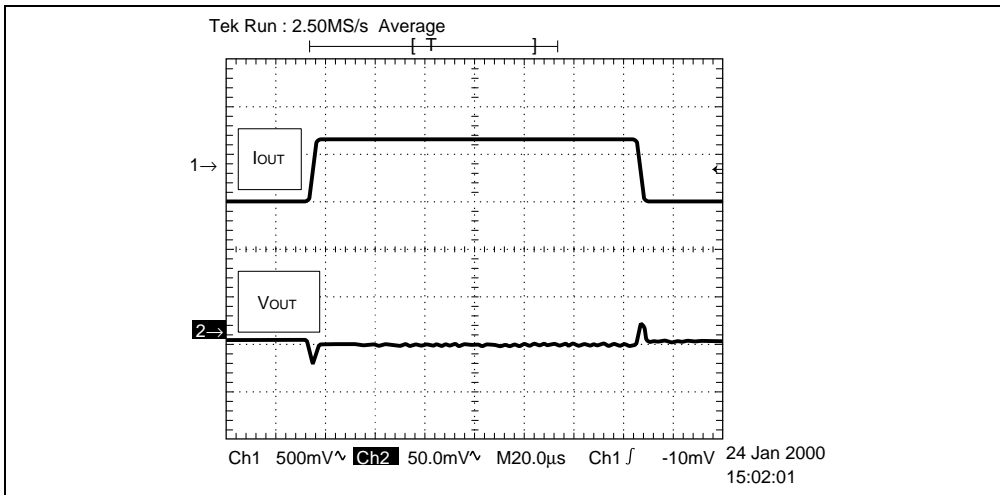

$I_{OUT}=50mA \leftrightarrow 100mA$   
 $V_{IN}=2.5V$   
 $C_{IN}=2.2\mu F$   
 $C_{OUT}=2.2\mu F$   
 $t_r/t_f=5\mu s$

**R11X2N201B**

$T_{opt}=25^{\circ}C$

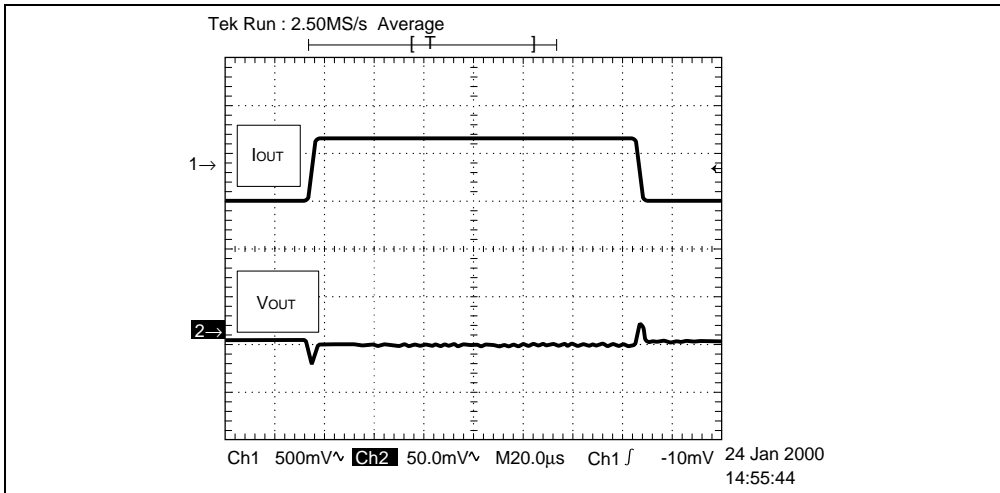

$I_{OUT}=50mA \leftrightarrow 100mA$   
 $V_{IN}=3.0V$   
 $C_{IN}=2.2\mu F$   
 $C_{OUT}=2.2\mu F$   
 $t_r/t_f=5\mu s$

**R11X2N301B**

$T_{opt}=25^{\circ}\text{C}$

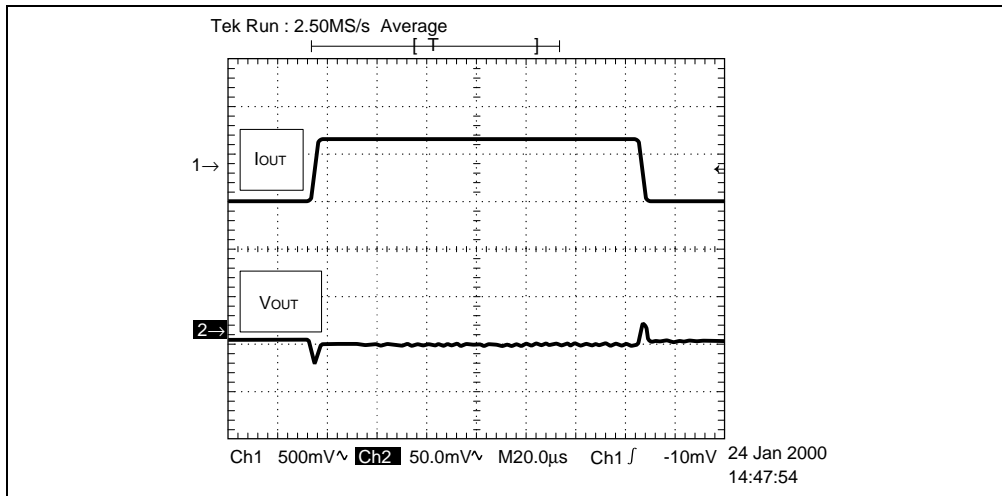

$I_{OUT}=50\text{mA}\leftrightarrow 100\text{mA}$   
 $V_{IN}=4.0\text{V}$   
 $C_{IN}=2.2\mu\text{F}$   
 $C_{OUT}=2.2\mu\text{F}$   
 $t_r/t_f=5\mu\text{s}$

**R11X2N401B**

$T_{opt}=25^{\circ}\text{C}$

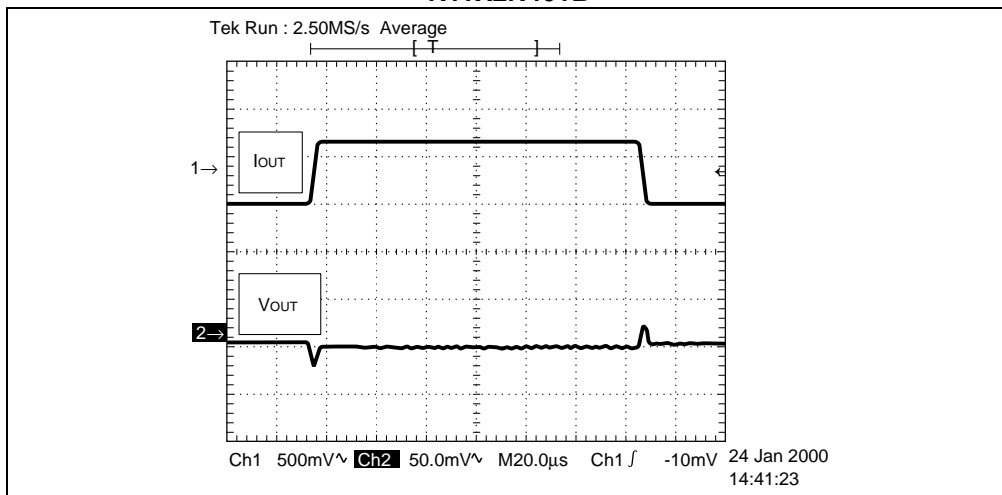

$I_{OUT}=50\text{mA}\leftrightarrow 100\text{mA}$   
 $V_{IN}=5.0\text{V}$   
 $C_{IN}=2.2\mu\text{F}$   
 $C_{OUT}=2.2\mu\text{F}$   
 $t_r/t_f=5\mu\text{s}$

**R11X2N501B**

$T_{opt}=25^{\circ}\text{C}$

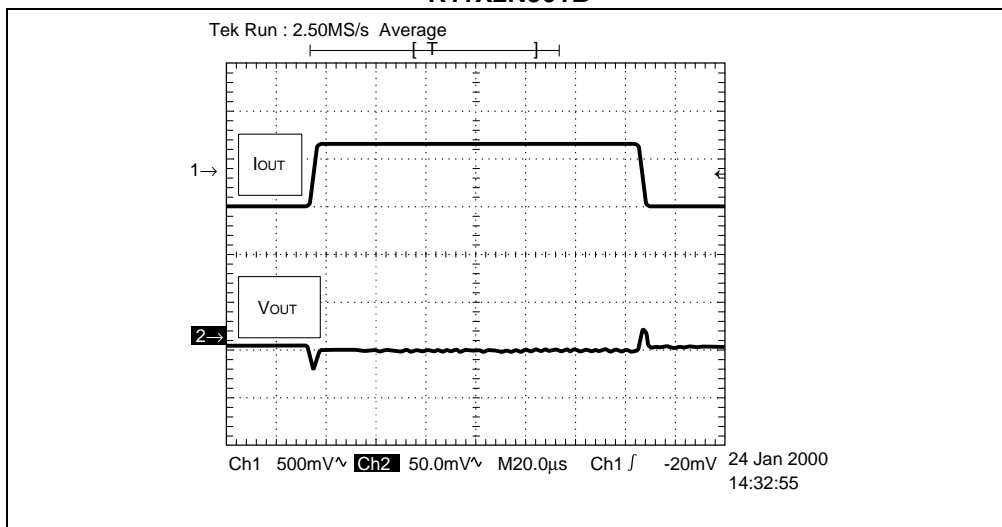

$I_{OUT}=50\text{mA}\leftrightarrow 100\text{mA}$   
 $V_{IN}=6.0\text{V}$   
 $C_{IN}=2.2\mu\text{F}$   
 $C_{OUT}=2.2\mu\text{F}$   
 $t_r/t_f=5\mu\text{s}$

## TECHNICAL NOTES

When using these ICs, consider the following points:

In these ICs, phase compensation is made for securing stable operation even if the load current is varied. For this purpose, be sure to use a capacitor  $C_{OUT}$  with good frequency characteristics and ESR (Equivalent Series Resistance) of which is in the range described as follows:

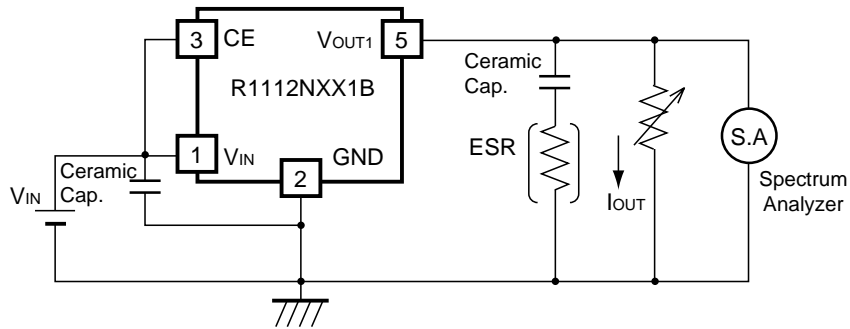

**Measuring Circuit for white noise; R1112NXX1B**

The relations between  $I_{OUT}$  (Output Current) and ESR of Output Capacitor are shown below. The conditions when the white noise level is under  $40\mu V$  (Avg.) are marked as the hatched area in the graph.

(note: When the additional ceramic capacitors are connected to the Output Pin with Output capacitor for phase compensation, the operation might be unstable. Because of this, test these ICs with as same external components as ones to be used on the PCB.)

<measuring conditions>

- (1)  $V_{IN} = V_{OUT} + 1V$
- (2) Frequency band: 10Hz to 1MHz
- (3) Temperature:  $25^{\circ}C$

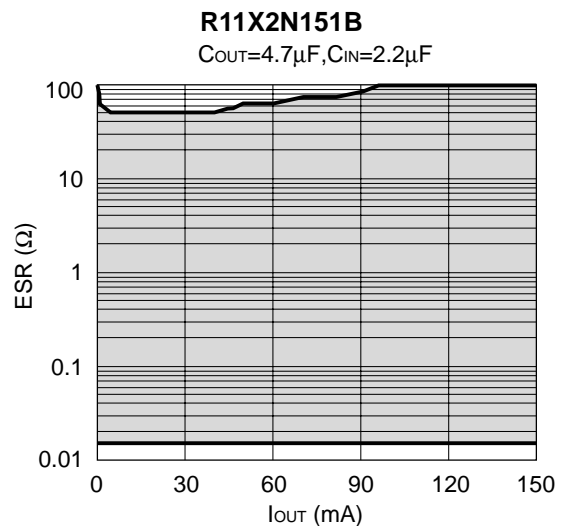
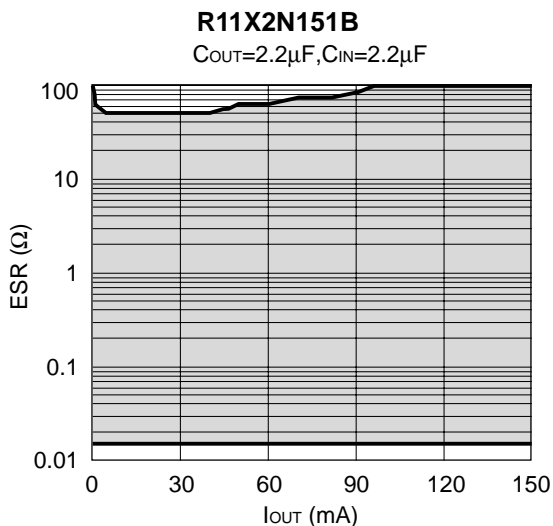

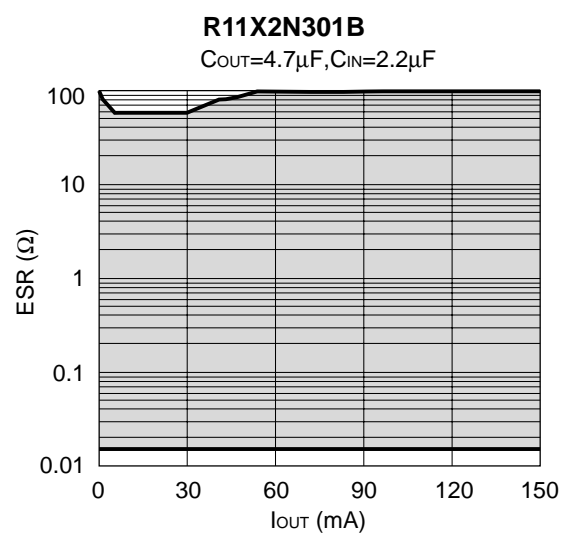
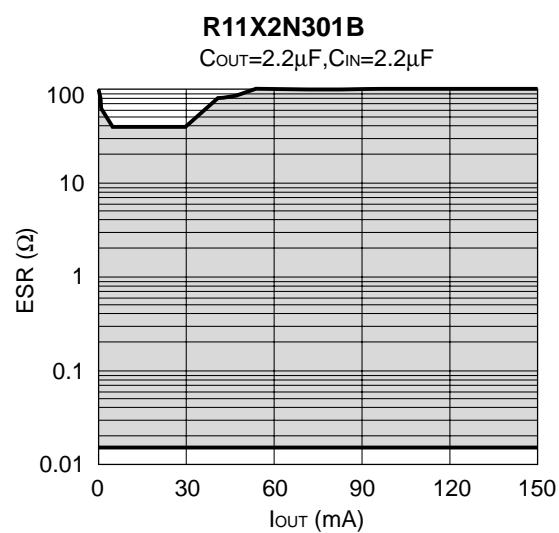

- Make  $V_{DD}$  and GND line sufficient. When the impedance of these is high, the noise might be picked up or not work correctly.
- Connect the capacitor with a capacitance of  $2.2\mu F$  or more between  $V_{DD}$  and GND as close as possible.
- Set external components, especially Output Capacitor, as close as possible to the ICs and make wiring shortest.