

## 800mA LDO REGULATOR R1170X series

### ■ OUTLINE

The R1170 Series are positive voltage regulator ICs by CMOS process. The R1170 Series have features of high ripple rejection, low dropout voltage, high output voltage accuracy, low consumption current. Each of these ICs consists of a voltage reference unit, an error amplifier, resistor net for setting output voltage, a current limit circuit at short mode, a chip enable circuit, and thermal-shunt circuit. Output Voltage of R1170 is fixed in the IC.

Low consumption current by the merit of CMOS process and built-in transistors with low ON-resistance make low dropout voltage and chip enable function prolong the battery life. These regulators are remarkable improvement on the current regulators in terms of ripple rejection, input transient response, and load transient response.

Maximum Output Current is large for its compact size.

Thus, the R1170 Series are suitable for various power sources for portable appliances.

Since the packages for these ICs are the SOT-89-5 package or HSON6, high density mounting of the ICs on boards is possible.

### ■ FEATURES

- Ultra-Low Supply Current ••••• TYP. 80 $\mu$ A
- Low Standby Current ••••• TYP. 0.1 $\mu$ A
- Output Current ••••• MIN. 800mA ( $V_{IN}=V_{OUT}+1.0V$ )
- Output Voltage ••••• Stepwise setting with a step of 0.1V in the range of 1.5V to 4.0V
- High Output Voltage Accuracy •••••  $\pm 2.0\%$
- Low Dropout Voltage ••••• TYP. 0.12V ( $V_{OUT}=3.0V, I_{OUT}=300mA$ )
- Line Regulation ••••• TYP. 0.05%/V
- Small Package ••••• SOT-89-5, HSON6
- Built-in Current Limit Circuit
- Built-in Thermal Shunt Circuit
- Low Temperature-drift Coefficient of Output Voltage ••••• TYP.  $\pm 100ppm/^{\circ}C$

### ■ APPLICATIONS

- Local Power source for Notebook PC.
- Local Power source for portable appliances, cameras, and videos.
- Local Power source for equipment of battery-use.
- Local Power source for home appliances.

## ■ BLOCK DIAGRAMS



## ■ SELECTION GUIDE

The output voltage, the chip-enable polarity, the taping type can be selected at the user's request. The selection can be made with the part number as follows;

R1170X XXXX-XX ← Part Number  
 ↑ ↑ ↑ ↑  
 a b c d

Code	Contents
a	Package Type; H: SOT89-5, D: HSON-6P
b	Designation of Output Voltage(V <sub>OUT</sub> ) Stepwise setting with 0.1V increment in the range from 1.5V to 4.0V
c	Designation of option; A: Built-in Chip Enable Circuit, Active at "L" B: Built-in Chip Enable Circuit, Active at "H"
d	Designation of Taping Type; T1 or T2 (SOT89-5), TR(HSON-6) (Refer to Taping Specifications)

## ■ PIN CONFIGURATION



● HSON-6P



■ PIN DESCRIPTION

SOT89-5

Pin No.	Symbol	Description
1	$\overline{CE}$ or CE	Chip Enable Pin Voltage Regulator Output Pin
2	GND	Ground Pin
3	NC	No Connection
4	VDD	Input Pin
5	VOUT	Voltage Regulator Output Pin

HSON-6P

Pin No.	Symbol	Description
1	VOUT	Voltage Regulator Output Pin
2	VOUT	Voltage Regulator Output Pin
3	$\overline{CE}$ or CE	Chip Enable Pin Voltage Regulator Output Pin
4	GND	Ground Pin
5	VDD	Input Pin
6	VDD	Input Pin

■ ABSOLUTE MAXIMUM RATINGS

Item	Symbol	Rating	Unit
Input Voltage	V <sub>IN</sub>	7.0	V
Input Voltage(CE or CE Input Pin)*Note	V <sub>CE</sub>	-0.3 ~ V <sub>IN</sub> +0.3	V
Output Voltage	V <sub>OUT</sub>	-0.3 ~ V <sub>IN</sub> +0.3	V
Output Current	I <sub>OUT</sub>	1.2	A
Power Dissipation	PD	Internally limited	
Operating Temperature	T <sub>opt</sub>	-40 ~ 85	°C
Storage Temperature	T <sub>stg</sub>	-55 ~ 125	°C

## ■ ELECTRICAL CHARACTERISTICS

### ●R1170XxxxA

(T<sub>opt</sub>=25°C)

Item	Symbol	Conditions	MIN.	TYP.	MAX.	Unit
Input Voltage	V <sub>IN</sub>				6.0	V
Supply Current <sup>1</sup>	I <sub>SS1</sub>	V <sub>IN</sub> -V <sub>OUT</sub> =1.0V V <sub>CE</sub> =GND		80	160	μA
Standby Current	I <sub>stb</sub>	V <sub>IN</sub> =V <sub>CE</sub> =6.0V		0.1	1.0	μA
Output voltage	V <sub>OUT</sub>	V <sub>IN</sub> -V <sub>OUT</sub> =1.0V I <sub>OUT</sub> =100mA	x0.98		x1.02	V
Output Current	I <sub>OUT1</sub>	V <sub>IN</sub> -V <sub>OUT</sub> =1.0V	800			mA
Load regulation	ΔV <sub>OUT</sub> / ΔI <sub>OUT</sub>	V <sub>IN</sub> -V <sub>OUT</sub> =1.0V 1mA≤I <sub>OUT</sub> ≤300mA		30	100	mV
Dropout Voltage	V <sub>DIF</sub>	I <sub>OUT</sub> =300mA	Refer to Dropout Voltage Table			
Line regulation	ΔV <sub>OUT</sub> / ΔV <sub>IN</sub>	I <sub>OUT</sub> =100mA V <sub>OUT</sub> +0.5V≤V <sub>IN</sub> ≤8.0V		0.05	0.30	%/V
Ripple Rejection	RR	f=1kHz,Ripple 0.5Vp-p V <sub>IN</sub> -V <sub>OUT</sub> =1.0V		50		dB
Output Voltage Temperature Coefficient	ΔV <sub>OUT</sub> / ΔT	I <sub>OUT</sub> =10mA -40°C ≤ T <sub>opt</sub> ≤ 85°C		±100		ppm /°C
Short Current Limit	I <sub>LIM</sub>	V <sub>OUT</sub> =0V		40		mA
Pull-up resistance for $\overline{CE}$ pin	R <sub>PU</sub>		1.25	2.50	5.00	MΩ
$\overline{CE}$ Input Voltage "H"	V <sub>CEH</sub>		1.50		V <sub>IN</sub>	V
$\overline{CE}$ Input Voltage "L"	V <sub>CEL</sub>		0.00		0.25	V
Thermal Shutdown Detector Threshold Temperature	T <sub>TSD</sub>	Junction Temperature		150		°C
Thermal Shutdown Released Temperature	T <sub>TSR</sub>	Junction Temperature		120		°C

●R1170xxxxB

(T<sub>opt</sub>=25°C)

Item	Symbol	Conditions	MIN.	TYP.	MAX.	Unit
Input voltage	V <sub>IN</sub>				6.0	V
Supply Current <sub>1</sub>	I <sub>SS1</sub>	V <sub>IN</sub> -V <sub>OUT</sub> =1.0V V <sub>CE</sub> =V <sub>IN</sub>		80	160	μA
Standby Current	I <sub>stb</sub>	V <sub>IN</sub> =6.0V, V <sub>CE</sub> =GND		0.1	1.0	μA
Reference Voltage for Adjustable Voltage Regulator	V <sub>OUT</sub>	V <sub>IN</sub> -V <sub>OUT</sub> =1.0V I <sub>OUT</sub> =100mA	x0.98		x1.02	V
Output Current	I <sub>OUT1</sub>	V <sub>IN</sub> -V <sub>OUT</sub> =1.0V	800			mA
Load regulation	ΔV <sub>OUT</sub> / ΔI <sub>OUT</sub>	V <sub>IN</sub> -V <sub>OUT</sub> =1.0V 1mA≤I <sub>OUT</sub> ≤300mA		30	100	mV
Dropout Voltage	V <sub>DIF</sub>	I <sub>OUT</sub> =300mA	Refer to Dropout Voltage Table			
Line regulation	ΔV <sub>OUT</sub> / ΔV <sub>IN</sub>	I <sub>OUT</sub> =100mA V <sub>OUT</sub> +0.5V≤V <sub>IN</sub> ≤8.0V		0.05	0.30	%/V
Ripple Rejection	RR	f=1kHz, Ripple 0.5Vp-p		50		dB
Output Voltage Temperature Coefficient	ΔV <sub>OUT</sub> / ΔT	-40°C≤T <sub>opt</sub> ≤85°C		±100		ppm /°C
Short Current Limit	I <sub>LIM</sub>	V <sub>OUT</sub> =0V		40		mA
Pull-down resistance for CE pin	R <sub>PD</sub>		1.25	2.5	5	MΩ
CE Input Voltage "H"	V <sub>CEH</sub>		1.5		V <sub>IN</sub>	V
CE Input Voltage "L"	V <sub>CEL</sub>		0		0.25	V
Thermal Shutdown Detector Threshold Temperature	T <sub>TS</sub>	Junction Temperature		150		°C
Thermal Shutdown Released Temperature	T <sub>TSR</sub>	Junction Temperature		120		°C

●Dropout Voltage by Output Voltage (T<sub>opt</sub>=25°C)

Output Voltage V <sub>OUT</sub> (V)	Dropout Voltage (V)	
	TYP.	MAX.
V <sub>OUT</sub> =1.5	0.35	0.45
V <sub>OUT</sub> =1.6	0.30	0.35
V <sub>OUT</sub> =1.7	0.25	0.30
1.8≤V <sub>OUT</sub> ≤2.0	0.20	0.25
2.1≤V <sub>OUT</sub> ≤2.4	0.15	0.20
2.5≤V <sub>OUT</sub> ≤4.0	0.12	0.18

## TEST CIRCUITS



Standard Test Circuit



Supply Current Test Circuit

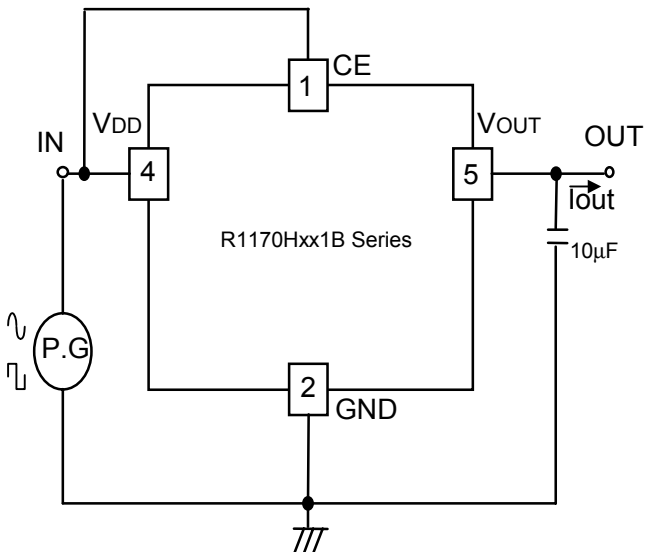

Test Circuit for Ripple Rejection, Input Transient Response



Test Circuit for Load Transient Response

---

---

## ■ Technical Notes on External Components and Typical Application

### Phase Compensation

In these ICs, phase compensation is made with Output capacitor for securing stable operation even if the load current is varied. For this purpose, use as much as 10 $\mu$ F Capacitor as  $C_L$ .

If you use a tantalum type capacitor and ESR value of the capacitor is large, output might be unstable. Evaluate your circuit with considering frequency characteristics. Further, refer to the Typical Characteristics No.12.

### Mounting on PCB

Make VDD and GND lines sufficient. If the impedance of these is high, current flows, the noise might be picked up or be a cause of unstable operation. Further use as much as 10 $\mu$ F Capacitor between VDD pin and GND pin as close as possible.

Set an Output capacitor between VOUT pin and GND pin for phase compensation as close as possible. (Refer to the example of typical application)

Example of the typical application of R1170HxxxB



$C_I=10\mu\text{F}$ (Ceramic),  $C_L=10\mu\text{F}$ (Ceramic)

## TYPICAL CHARACTERISTICS

### 1) Output Voltage vs. Output Current (T<sub>opt</sub>=25°C)



### 2) Output Voltage vs. Input Voltage (T<sub>opt</sub>=25°C)







### 3) Dropout Voltage vs. Output Current

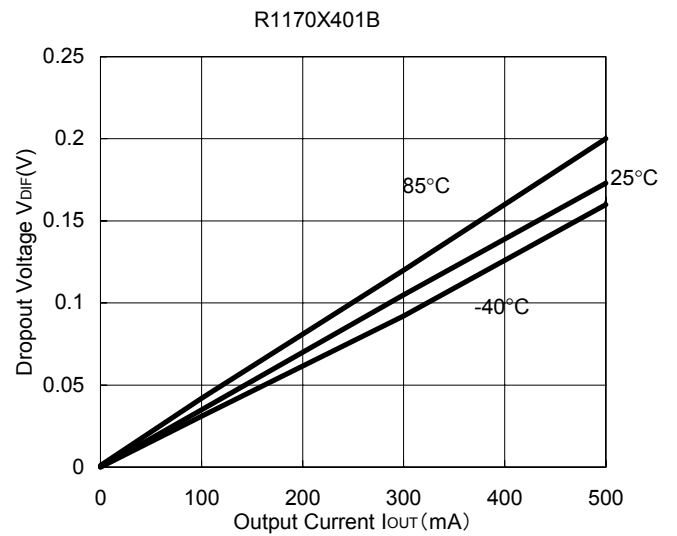
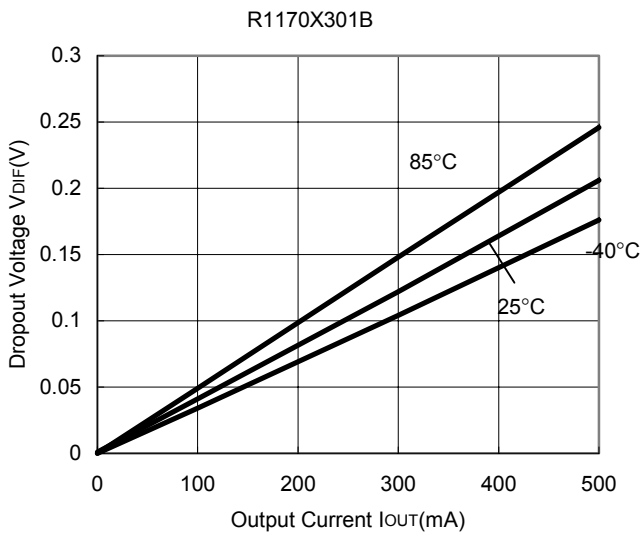
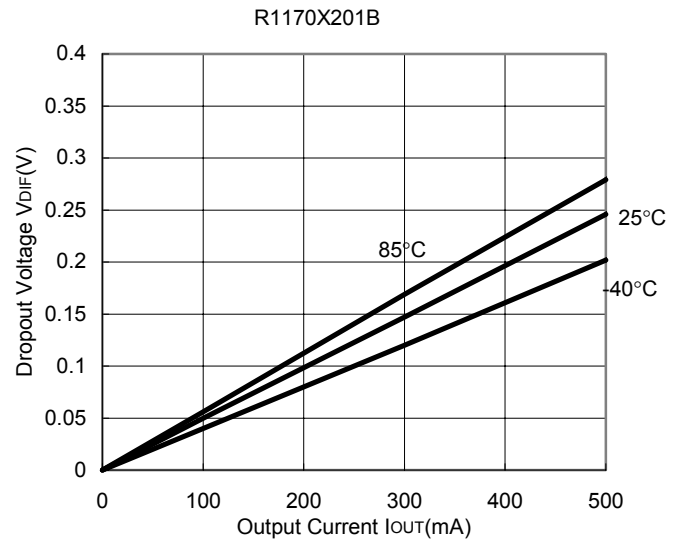
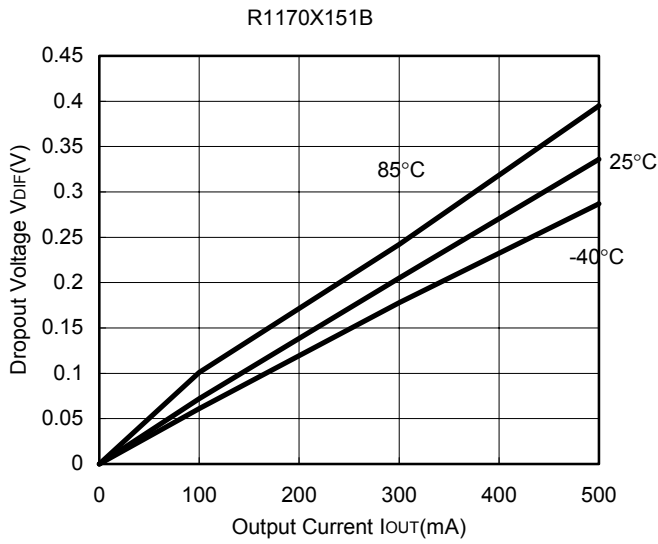

4) Output Voltage vs. Temperature

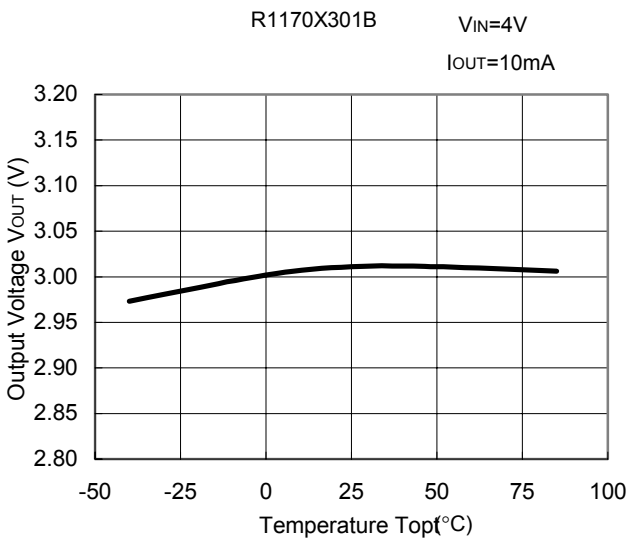

5) Supply Current vs. Input Voltage (Top=25°C)





6) Supply Current vs. Temperature



7) Dropout Voltage vs. Set Output Voltage( $T_{opt}=25^{\circ}C$ )



8) Ripple Rejection vs. Frequency

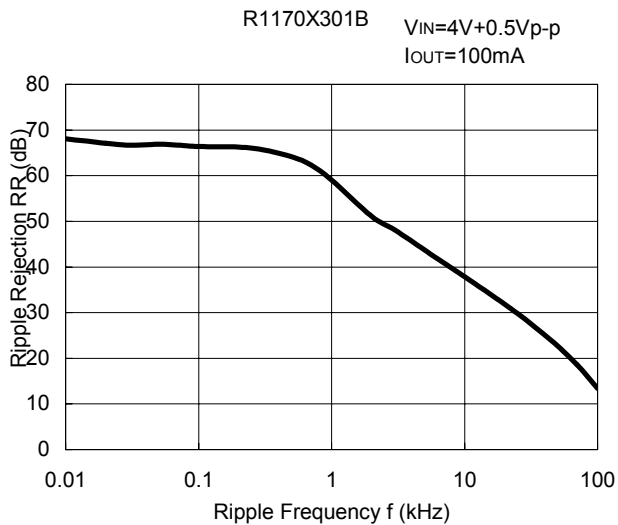

### 9) Ripple Rejection vs. Input Voltage



### 10) Input Transient Response (T<sub>opt</sub>=25°C)



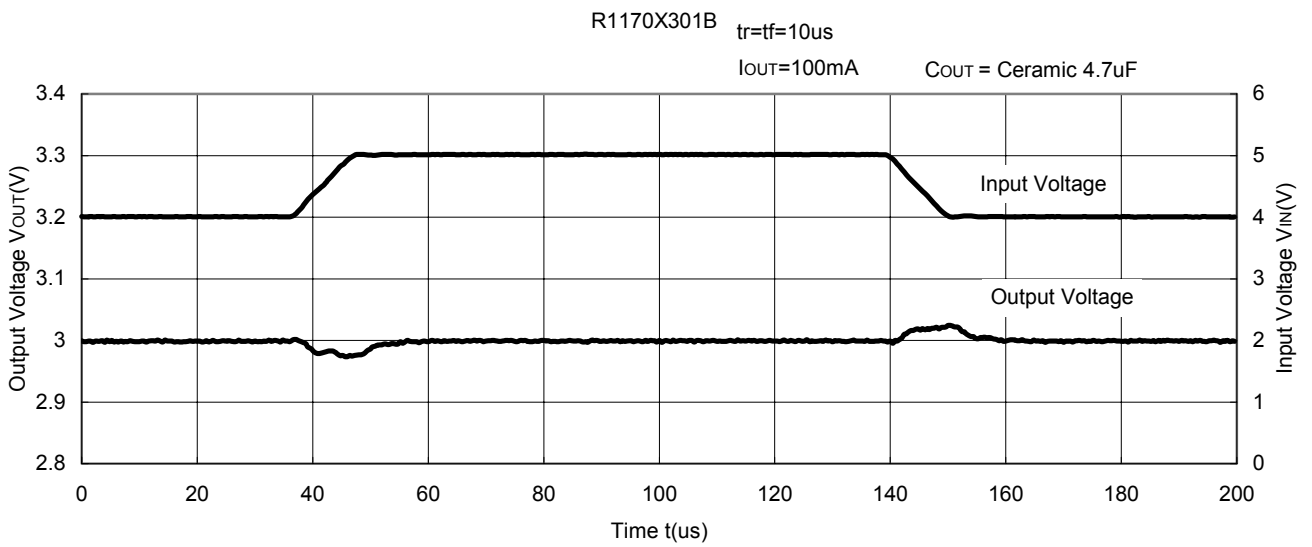

11) Load Transient Response  $T_{opt}=25^{\circ}C$





12) Stable Area ( $T_{opt}=25^{\circ}C, V_{IN}=\text{Set Output Voltage}+1V, C_{IN}=\text{Ceramic } 10\mu F$ )



As an output capacitor for this IC, Ceramic capacitor is recommendable. However, other low ESR type capacitor can be used with this IC.

For your reference, noise level is tested with the circuit as shown above, and if the noise level is  $40\mu V$  or less than  $40\mu V$ , the ESR values are plotted as stable area. Upper limit is described in the next four graphs, or ESR vs. Output Current. (Hatched area is the stable area.)

