

# LH52B256LL

**PRELIMINARY**  
**CMOS 32K × 8 Static RAM**

## FEATURES

- Access Times: 70/100 ns
- Automatic Power Down During Long Read Cycles
- Low-Power Standby When Deselected
- TTL Compatible I/O
- 5 V ± 10% Supply
- Fully-Static Operation
- 2 V Data Retention
- Packages:
  - 28-Pin, 300-mil DIP
  - 28-Pin, 600-mil DIP
  - 28-Pin, 450-mil SOP
  - 28-Pin, 8 × 13 mm<sup>2</sup> TSOP (Type I)

## FUNCTIONAL DESCRIPTION

The LH52B256LL is a high-density 262,144 bit static RAM organized as 32K × 8. An efficient design is obtained with a CMOS periphery and a matrix constructed with polysilicon load memory cells.

This RAM is fully static in operation. The Chip Enable ( $\bar{E}$ ) control permits Read and Write operations when active (LOW) or places the RAM in a low-power standby mode when inactive (HIGH). Standby power ( $I_{SB1}$ ) drops to its lowest level if  $\bar{E}$  is raised to within 0.2 V of  $V_{CC}$ .

Write cycles occur when both Chip Enable ( $\bar{E}$ ) and Write Enable ( $\bar{W}$ ) are LOW. Data is transferred from the DQ pins to the memory location specified by the 15 address lines. The proper use of the Output Enable control ( $\bar{G}$ ) can prevent bus contention.

When  $\bar{E}$  is LOW and  $\bar{W}$  is HIGH, a static Read will occur at the memory location specified by the address lines.  $\bar{G}$  must be brought LOW to enable the outputs. Since the device is fully static in operation, new Read cycles can be performed by simply changing the address. An Automatic Power Down feature decreases current consumption when Read cycles extend beyond their minimum cycle time.

High-frequency design techniques should be employed to obtain the best performance from this device. Solid, low-impedance power and ground planes, with high-frequency decoupling capacitors, are recommended. Series termination of the inputs should be considered when transmission line effects occur.

## PIN CONNECTIONS

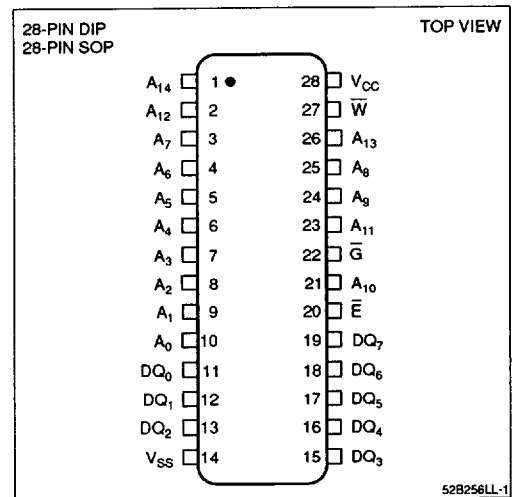

Figure 1. Pin Connections for DIP and SOP Packages

SHARP CORP

61E D ■ 8180798 0009758 729 ■ SRPJ

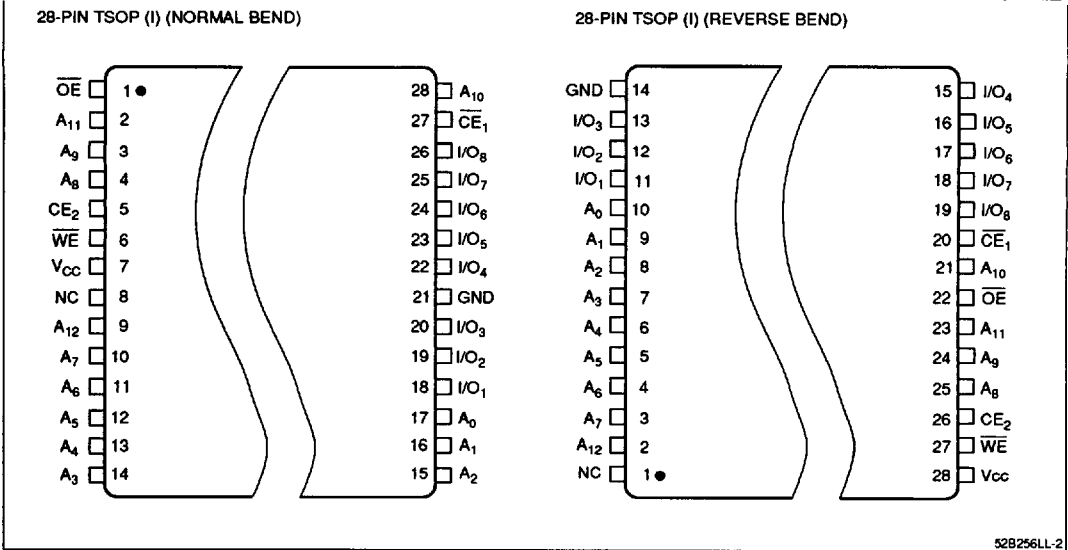
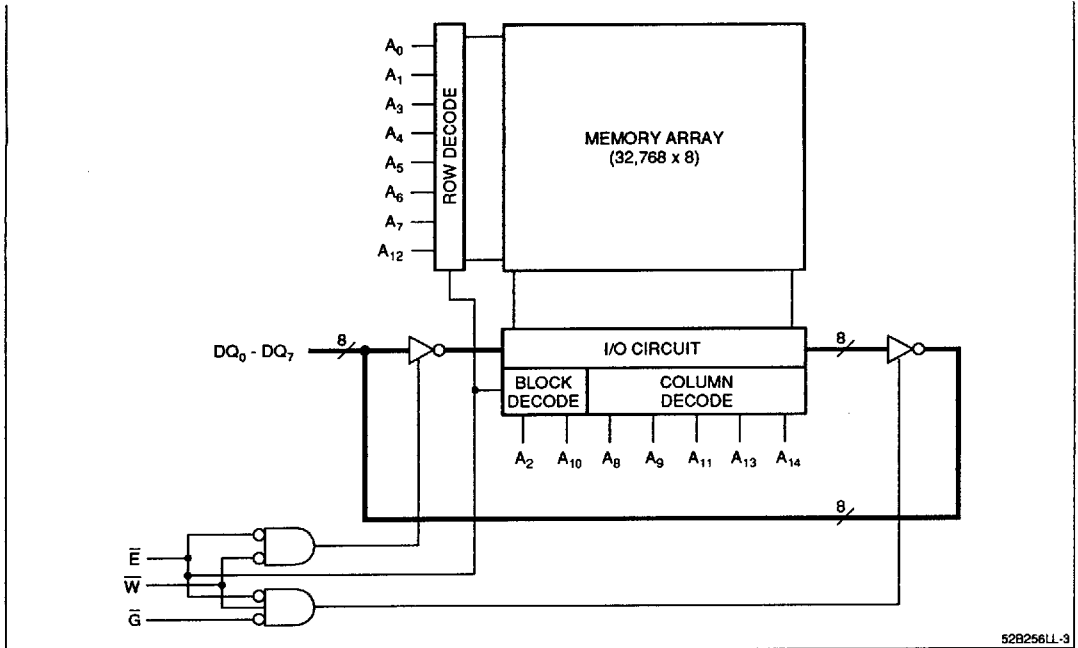

Figure 2. Pin Connections for TSOP Packages

SHARP CORP

61E D ■ 8180798 0009759 665 ■ SRPJ



52B256LL-3

Figure 3. LH52B256LL Block Diagram

## TRUTH TABLE

$\bar{E}$	$\bar{G}$	$\bar{W}$	MODE	DQ	I <sub>cc</sub>
H	X	X	Standby	High-Z	Standby
L	H	H	Read	High-Z	Active
L	L	H	Read	Data Out	Active
L	X	L	Write	Data In	Active

## NOTE:

X = Don't Care, L = LOW, H = HIGH

## PIN DESCRIPTIONS

PIN	DESCRIPTION
A <sub>0</sub> - A <sub>14</sub>	Address Inputs
DQ <sub>0</sub> - DQ <sub>7</sub>	Data Inputs/Outputs
$\bar{E}$	Chip Enable input
$\bar{G}$	Output Enable input
$\bar{W}$	Write Enable input
V <sub>cc</sub>	Positive Power Supply
V <sub>ss</sub>	Ground

SHARP CORP

6JE D ■ 8180798 0009760 387 ■ SRPJ

ABSOLUTE MAXIMUM RATINGS<sup>1</sup>

PARAMETER	RATING
V <sub>CC</sub> to V <sub>SS</sub> Potential	-0.5 V to 7 V
Input Voltage Range	-0.5 V to V <sub>CC</sub> + 0.5 V
DC Output Current <sup>2</sup>	± 40 mA
Storage Temperature Range	-65°C to 150°C
Power Dissipation (Package Limit)	1.0 W

## NOTES:

- Stresses greater than those listed under 'Absolute Maximum Ratings' may cause permanent damage to the device. This is a stress rating for transient conditions only. Functional operation of the device at these or any other conditions above those indicated in the 'Operating Range' of this specification is not implied. Exposure to absolute maximum rating conditions for extended periods may affect reliability.
- Outputs should not be shorted for more than 30 seconds. No more than one output should be shorted at any time.

## OPERATING RANGES

SYMBOL	PARAMETER	MIN	TYP	MAX	UNIT
T <sub>A</sub>	Temperature, Ambient	0		70	°C
V <sub>CC</sub>	Supply Voltage	4.5	5.0	5.5	V
V <sub>SS</sub>	Supply Voltage	0	0	0	V
V <sub>IL</sub>	Logic '0' Input Voltage <sup>1</sup>	-0.5		0.8	V
V <sub>IH</sub>	Logic '1' Input Voltage	2.2		V <sub>CC</sub> + 0.5	V

## NOTE:

- Negative undershoot of up to 3.0 V is permitted once per cycle.

## DC ELECTRICAL CHARACTERISTICS

SYMBOL	PARAMETER	TEST CONDITIONS	MIN	TYP	MAX	UNIT
I <sub>CC1</sub>	Operating Current <sup>1</sup>	t <sub>RC</sub> = 70 ns			70	mA
I <sub>CC1</sub>	Operating Current <sup>1</sup>	t <sub>RC</sub> = 100 ns			70	mA
I <sub>SB1</sub>	Standby Current	$\bar{E} \geq V_{CC} - 0.2 V$			40	μA
I <sub>SB2</sub>	Standby Current	$\bar{E} \geq V_{IH}$			3	mA
I <sub>LI</sub>	Input Leakage Current	V <sub>IN</sub> = 0 V to V <sub>CC</sub>	-1		1	μA
I <sub>LO</sub>	I/O Leakage Current	V <sub>IN</sub> = 0 V to V <sub>CC</sub>	-1		1	μA
V <sub>OH</sub>	Output High Voltage	I <sub>OH</sub> = -1.0 mA	2.4			V
V <sub>OL</sub>	Output Low Voltage	I <sub>OL</sub> = 2.0 mA			0.4	V
V <sub>DR</sub>	Data Retention Voltage	$\bar{E} \geq V_{CC} - 0.2 V$	2		5.5	V
I <sub>DR</sub>	Data Retention Current	V <sub>CC</sub> = 3 V, $\bar{E} \geq V_{CC} - 0.2 V$		6	20	μA

## NOTE:

- I<sub>CC</sub> is dependent upon output loading and cycle rates. Specified values are with outputs open, operating at specified cycle times.

SHARP CORP  
AC TEST CONDITIONS

61E D ■ 8180798 0009761 213 ■ SRPJ

PARAMETER	RATING
Input Pulse Levels	0.6 to 2.4 V
Input Rise and Fall Times	10 ns
Input and Output Timing Ref. Levels	1.5 V
Output Load, Timing Tests	Figure 3

CAPACITANCE <sup>1,2</sup>

PARAMETER	RATING
C <sub>IN</sub> (Input Capacitance)	7 pF
C <sub>DQ</sub> (I/O Capacitance)	10 pF

NOTES:

- Capacitances are maximum values at 25°C measured at 1.0MHz with V<sub>bias</sub> = 0 V and V<sub>CC</sub> = 5.0 V.
- Sample tested only.

DATA RETENTION TIMING

$\bar{E}$  must be held above the lesser of V<sub>IH</sub> or V<sub>CC</sub> - 0.2 V to assure proper operation when V<sub>CC</sub> < 4.5 V.  $\bar{E}$  must be V<sub>CC</sub> - 0.2 V or greater to meet I<sub>DR</sub> specification. All other inputs are 'Don't Care.'

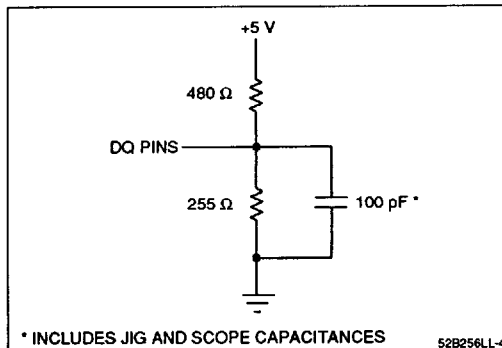

Figure 4. Output Load Circuit

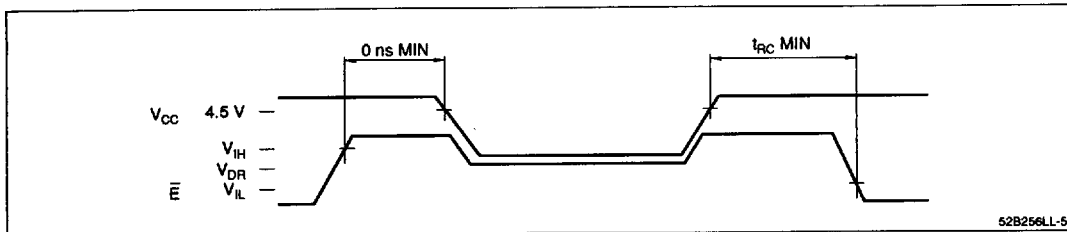

Figure 5. Data Retention Timing

SHARP CORP

61E D ■ 8180798 0009762 15T ■ SRPJ

AC ELECTRICAL CHARACTERISTICS<sup>1</sup> (Over Operating Range)

SYMBOL	DESCRIPTION	-70		-10		UNITS
		MIN	MAX	MIN	MAX	
<b>READ CYCLE</b>						
t <sub>RC</sub>	Read Cycle Time	70		100		ns
t <sub>AA</sub>	Address Access Time		70		100	ns
t <sub>OH</sub>	Output Hold from Address Change	10		10		ns
t <sub>EA</sub>	$\bar{E}$ Low to Valid Data		70		100	ns
t <sub>ELZ</sub>	$\bar{E}$ Low to Output Active <sup>2,3</sup>	10		5		ns
t <sub>EHZ</sub>	$\bar{E}$ High to Output High-Z <sup>2,3</sup>	0	35	0	45	ns
t <sub>GA</sub>	$\bar{G}$ Low to Valid Data		40		60	ns
t <sub>GLZ</sub>	$\bar{G}$ Low to Output Active <sup>2,3</sup>	5		5		ns
t <sub>GHZ</sub>	$\bar{G}$ High to Output High-Z <sup>2,3</sup>	0	35	0	45	ns
<b>WRITE CYCLE</b>						
t <sub>WC</sub>	Write Cycle Time	70		100		ns
t <sub>EW</sub>	$\bar{E}$ Low to End of Write	60		65		ns
t <sub>AW</sub>	Address Valid to End of Write	60		90		ns
t <sub>AS</sub>	Address Setup	0		0		ns
t <sub>WR</sub>	Address Hold from End of Write	0		0		ns
t <sub>WP</sub>	$\bar{W}$ Pulse Width	55		65		ns
t <sub>DW</sub>	Input Data Setup Time	30		35		ns
t <sub>DH</sub>	Input Data Hold Time	0		0		ns
t <sub>WHZ</sub>	$\bar{W}$ Low to Output High-Z <sup>2,3</sup>	0	40	0	45	ns
t <sub>WLZ</sub>	$\bar{W}$ High to Output Active <sup>2,3</sup>	5		5		ns

## NOTES:

- AC Electrical Characteristics specified at 'AC Test Conditions' levels.
- Active output to High-Z and High-Z to output active tests specified for a  $\pm 200$  mV transition from steady state levels into the test load.
- Sample tested only.

**TIMING DIAGRAMS – READ CYCLE**

**Read Cycle No. 1**

Chip is in Read Mode:  $\bar{W}$  is HIGH,  $\bar{E}$  is LOW and  $\bar{G}$  is LOW. Read Cycle timing is referenced from when all addresses are stable until the first address transition. Crosshatched portion of Data Out implies that data lines are in the Low-Z state but the data is not guaranteed to be valid until  $t_{AA}$ .

**Read Cycle No. 2**

Chip is in Read Mode:  $\bar{W}$  is HIGH. Timing illustrated for the case when addresses are valid before  $\bar{E}$  goes LOW. Data Out is not specified to be valid until  $t_{EA}$  or  $t_{GA}$ , but may become valid as soon as  $t_{ELZ}$  or  $t_{GLZ}$ . Outputs will transition directly from High-Z to Valid Data Out. Valid Data will be present following  $t_{GA}$  only if  $t_{EA}$  timing is met.

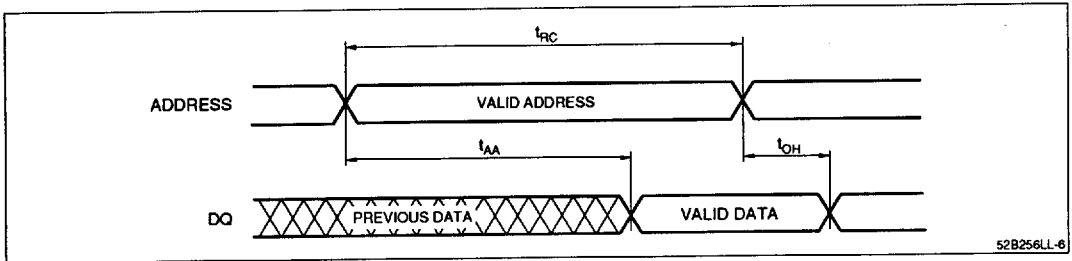

Figure 6. Read Cycle No. 1

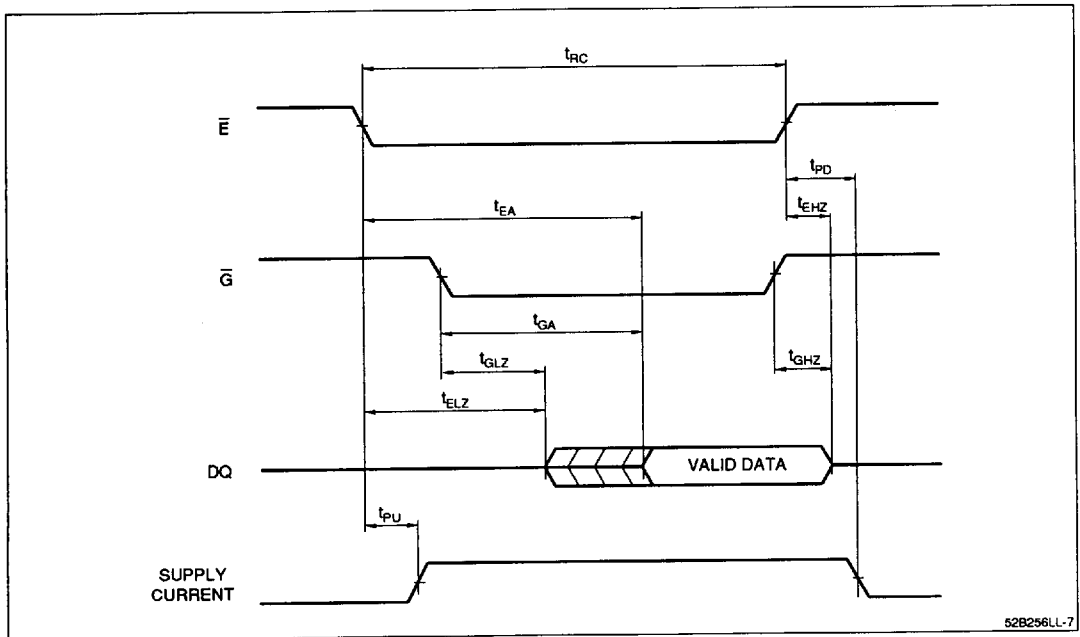

Figure 7. Read Cycle No. 2

SRPJ 096 0009763 096 6JE D 8180798 SHARP CORP

**TIMING DIAGRAMS – WRITE CYCLE**

Addresses must be stable during Write Cycles. The outputs will remain in the High-Z state if  $\overline{W}$  is LOW when  $\overline{E}$  goes LOW. If  $\overline{G}$  is HIGH, the outputs will remain in the High-Z state. Although these examples illustrate timing with  $\overline{G}$  active, it is recommended that  $\overline{G}$  be held HIGH for all Write cycles. This will prevent the LH52B256LL's outputs from becoming active, preventing bus contention, thereby reducing system noise.

Chip is selected:  $\overline{E}$  is LOW,  $\overline{G}$  is LOW. Using only  $\overline{W}$  to control Write Cycles may not offer the best performance since both  $t_{WHZ}$  and  $t_{OW}$  timing specifications must be met.

**Write Cycle No. 2 ( $\overline{E}$  Controlled)**

$\overline{G}$  is LOW. DQ lines may transition to Low-Z if the falling edge of  $\overline{W}$  occurs after the falling edge of  $\overline{E}$ .

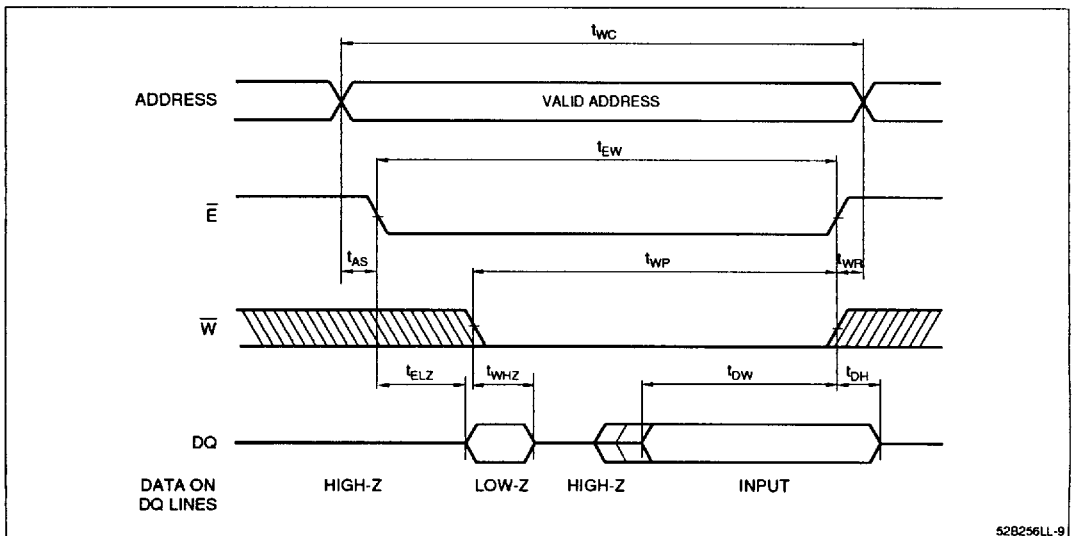
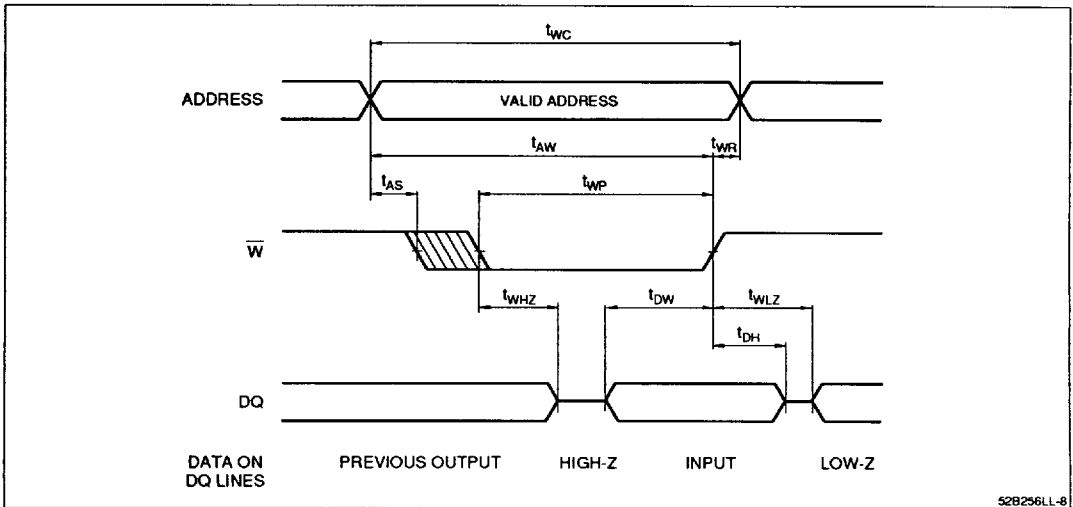



## ORDERING INFORMATION

