

Programmable Charge Pump

- +5V Only Low Power Voltage Conversion
- Programmable Between $\pm 5V$ or $\pm 10V$
- Low Power Shutdown Mode

Applications

- RS-232/RS-423 transceiver power supplies
- LCD BIAS Generator
- OP-Amp Power Supplies



DESCRIPTION...

The **SP782** and **SP784** are monolithic programmable voltage converters that produce a positive and negative voltage from a single supply. The **SP782** and **SP784** are programmable such that the charge pump outputs either a $\pm 10V$ voltage or a $\pm 5V$ voltage by control of two pins. Both products require four (4) charge pump capacitors to support the resulting output voltages. The charge pump architecture (U.S. 5,760,637) is fabricated using a low power BiCMOS process technology.

The **SP782** and **SP784** charge pumps can be powered from a single +5V supply. The low power consumption makes these charge pumps ideal for battery operated equipment. Both offer a shutdown feature that saves battery life. A system can essentially have four (4) different supply voltages from a single battery. Typical applications are handheld instruments, notebook and laptop computers, and data acquisition systems.

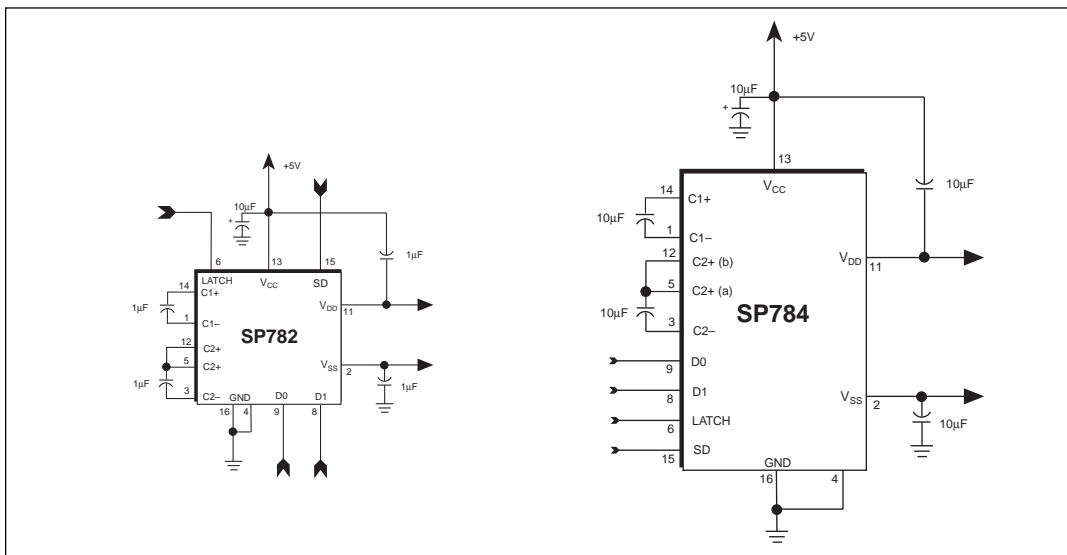

ABSOLUTE MAXIMUM RATINGS

These are stress ratings only and functional operation of the device at these ratings or any other above those indicated in the operation sections of the specifications below is not implied. Exposure to absolute maximum rating conditions for extended periods of time may affect reliability.

| | |
|--------------------------|-----------------|
| V_{CC} | +7V |
| V_{DD} | +11V |
| V_{SS} | -11V |
| Storage Temperature..... | -65°C to +150°C |
| Power Dissipation | |
| 16-pin Plastic DIP..... | 1000mW |
| 16-pin Plastic SOIC..... | 1000mW |

| | |
|---------------------|--------|
| Package Derating: | |
| 16-pin Plastic DIP | |
| θ_{JA} | 62°C/W |
| 16-pin Plastic SOIC | |
| θ_{JA} | 62°C/W |

SP782 SPECIFICATIONS

Typical @ 25°C and $V_{CC} = V_{CC} \pm 5\%$ unless otherwise noted.

| | MIN. | TYP. | MAX. | UNITS | CONDITIONS |
|--------------------------------------|-------|------|-------|---------|---|
| SUPPLY CURRENT | | | | | CHARGE PUMP CAPACITORS: 1μF |
| I_{CC} | | 3 | 8 | mA | $V_{CC} = +5V, R_L = \infty, V_O = 2 \times V_{CC}$ |
| Shutdown I_{CC} | | 1 | 2 | mA | $V_{CC} = +5V, R_L = \infty, V_O = V_{CC}$ |
| | | 10 | 25 | μ A | $V_{CC} = +5V, SD = V_{CC}$ |
| POSITIVE CHARGE PUMP OUTPUT | | | | | CHARGE PUMP CAPACITORS: 1μF |
| V_{DD} (2 $\times V_{CC}$ Output) | +9.5 | +9.8 | +10.0 | Volts | $V_{CC} = +5V, D_0 = 0V, D_1 = 0V$ |
| | +8.0 | +8.5 | | Volts | $R_L = \infty$ |
| | | | | Volts | $V_{CC} = +5V, D_0 = 0V, D_1 = 0V$ |
| V_{DD} (V_{CC} Output) | +4.2 | +4.5 | +5.0 | Volts | $R_L = 1k\Omega$ |
| | +4.2 | +4.5 | | Volts | $V_{CC} = +5V, D_0 = V_{CC}, D_1 = V_{CC}$ |
| | | | | Volts | $R_L = \infty$ |
| | | | | Volts | $V_{CC} = +5V, D_0 = V_{CC}, D_1 = V_{CC}$ |
| | | | | Volts | $R_L = 1k\Omega$ |
| NEGATIVE CHARGE PUMP OUTPUT | | | | | CHARGE PUMP CAPACITORS: 1μF |
| V_{SS} (2 $\times V_{CC}$ Output) | -9.5 | -9.8 | -10.0 | Volts | $V_{CC} = +5V, D_0 = 0V, D_1 = 0V$ |
| | -8.0 | -8.5 | | Volts | $R_L = \infty$ |
| | | | | Volts | $V_{CC} = +5V, D_0 = 0V, D_1 = 0V$ |
| V_{SS} ($-V_{CC}$ Output) | -4.2 | -4.5 | -5.0 | Volts | $R_L = 1k\Omega$ |
| | -4.0 | -4.2 | | Volts | $V_{CC} = +5V, D_0 = V_{CC}, D_1 = V_{CC}$ |
| | | | | Volts | $R_L = \infty$ |
| | | | | Volts | $V_{CC} = +5V, D_0 = V_{CC}, D_1 = V_{CC}$ |
| | | | | Volts | $R_L = 1k\Omega$ |
| OSCILLATOR FREQUENCY | | | | | |
| f_{OSC} | | 300 | | kHz | SD = 0V |
| VOLTAGE CONVERSION EFFICIENCY | | | | | |
| V_{DD} (2 $\times V_{CC}$ Output) | 95 | 98 | | % | $R_L = \infty$ |
| V_{DD} (2 $\times V_{CC}$ Output) | 80 | 85 | | % | $R_L = 1k\Omega$ |
| V_{SS} (2 $\times V_{CC}$ Output) | 85 | 90 | | % | $R_L = \infty$ |
| V_{SS} (2 $\times V_{CC}$ Output) | 80 | 85 | | % | $R_L = 1k\Omega$ |
| POWER REQUIREMENTS | | | | | |
| V_{CC} | +4.75 | | +5.25 | Volts | |
| ENVIRONMENTAL AND MECHANICAL | | | | | |
| Operating Temperature Range | 0 | | +70 | °C | |
| Storage Temperature Range | -65 | | +150 | °C | |

ABSOLUTE MAXIMUM RATINGS

These are stress ratings only and functional operation of the device at these ratings or any other above those indicated in the operation sections of the specifications below is not implied. Exposure to absolute maximum rating conditions for extended periods of time may affect reliability.

| | |
|--------------------------|-----------------|
| V_{CC} | +7V |
| V_{DD} | +11V |
| V_{SS} | -11V |
| Storage Temperature..... | -65°C to +150°C |
| Power Dissipation | |
| 16-pin Plastic DIP..... | 1000mW |
| 16-pin Plastic SOIC..... | 1000mW |

Package Derating:

16-pin Plastic DIP

θ_{JA}62 °C/W

16-pin Plastic SOIC

θ_{JA}62 °C/W

SP784 SPECIFICATIONS

Typical @ 25°C and $V_{CC} = V_{CC} \pm 5\%$ unless otherwise noted.

| | MIN. | TYP. | MAX. | UNITS | CONDITIONS |
|--------------------------------------|-------|------|-------|---------|---|
| SUPPLY CURRENT | | | | | CHARGE PUMP CAPACITORS: 10μF |
| I_{CC} | | 5 | 10 | mA | $V_{CC} = +5V, R_L = \infty, V_O = 2 \times V_{CC}$ |
| Shutdown I_{CC} | | 1 | 5 | mA | $V_{CC} = +5V, R_L = \infty, V_O = V_{CC}$ |
| | | 10 | 25 | μ A | $V_{CC} = +5V, SD = V_{CC}$ |
| POSITIVE CHARGE PUMP OUTPUT | | | | | CHARGE PUMP CAPACITORS: 10μF |
| V_{DD} (2 $\times V_{CC}$ Output) | +9.0 | +9.8 | +10.0 | Volts | $V_{CC} = +5V, D_0 = 0V, D_1 = 0V$ |
| | +8.0 | +9.5 | | Volts | $R_L = \infty$ |
| | | | | Volts | $V_{CC} = +5V, D_0 = 0V, D_1 = 0V$ |
| | | | | Volts | $R_L = 1k\Omega$ |
| V_{DD} (V_{CC} Output) | +4.5 | +4.8 | +5.0 | Volts | $V_{CC} = +5V, D_0 = V_{CC}, D_1 = V_{CC}$ |
| | +4.2 | +4.5 | | Volts | $R_L = \infty$ |
| | | | | Volts | $V_{CC} = +5V, D_0 = V_{CC}, D_1 = V_{CC}$ |
| | | | | Volts | $R_L = 1k\Omega$ |
| NEGATIVE CHARGE PUMP OUTPUT | | | | | CHARGE PUMP CAPACITORS: 10μF |
| V_{SS} (2 $\times V_{CC}$ Output) | -9.0 | -9.8 | -10.0 | Volts | $V_{CC} = +5V, D_0 = 0V, D_1 = 0V$ |
| | -8.0 | -9.5 | | Volts | $R_L = \infty$ |
| | | | | Volts | $V_{CC} = +5V, D_0 = 0V, D_1 = 0V$ |
| | | | | Volts | $R_L = 1k\Omega$ |
| V_{SS} ($-V_{CC}$ Output) | -4.2 | -4.5 | -5.0 | Volts | $V_{CC} = +5V, D_0 = V_{CC}, D_1 = V_{CC}$ |
| | -4.0 | -4.2 | | Volts | $R_L = \infty$ |
| | | | | Volts | $V_{CC} = +5V, D_0 = V_{CC}, D_1 = V_{CC}$ |
| | | | | Volts | $R_L = 1k\Omega$ |
| OSCILLATOR FREQUENCY | | | | | |
| f_{osc} | | 300 | | kHz | SD = 0V |
| VOLTAGE CONVERSION EFFICIENCY | | | | | |
| V_{DD} (2X V_{CC} Output) | 90 | 98 | | % | $R_L = \infty$ |
| V_{DD} (2X V_{CC} Output) | 80 | 95 | | % | $R_L = 1k\Omega$ |
| V_{SS} (2X V_{CC} Output) | 90 | 98 | | % | $R_L = \infty$ |
| V_{SS} (2X V_{CC} Output) | 80 | 95 | | % | $R_L = 1k\Omega$ |
| POWER REQUIREMENTS | | | | | |
| V_{CC} | +4.75 | | +5.25 | Volts | |
| ENVIRONMENTAL AND MECHANICAL | | | | | |
| Operating Temperature Range | 0 | | +70 | °C | |
| Storage Temperature Range | -65 | | +150 | °C | |

AC CHARACTERISTICS*

(Typical @ 25°C and nominal supply voltages unless otherwise noted)

| PARAMETER | MIN. | TYP. | MAX. | UNITS | CONDITIONS |
|--|------|--------------|------|--------------------------------|--|
| SP782 POWER-UP DELAY TIME | | | | | |
| ±10V OUTPUT $t_{DVDD}; V_{DD}$ Power On Delay $t_{DVSS}; V_{SS}$ Power-On Delay | | 1000 1000 | | μs μs | $R_L = 1\text{k}\Omega$ $R_L = 1\text{k}\Omega$ |
| ±5V OUTPUT $t_{DVDD}; V_{DD}$ Power On Delay $t_{DVSS}; V_{SS}$ Power-On Delay | | 10 150 | | μs μs | $R_L = 1\text{k}\Omega$ $R_L = 1\text{k}\Omega$ |
| SP782 OUTPUT DELAY TIME | | | | | |
| t_{SD1} ; Switching Delay from $\pm 10\text{V}$ to $\pm 5\text{V}$ | | 1000 | | μs | $R_L = 1\text{k}\Omega$ |
| t_{SD2} ; Switching Delay from $\pm 5\text{V}$ to $\pm 10\text{V}$ | | 500 | | μs | $R_L = 1\text{k}\Omega$ |
| SP784 POWER-UP DELAY TIME | | | | | |
| ±10V OUTPUT $t_{DVDD}; V_{DD}$ Power On Delay $t_{DVSS}; V_{SS}$ Power-On Delay | | 5 5 | | ms ms | $R_L = 1\text{k}\Omega$ $R_L = 1\text{k}\Omega$ |
| ±5V OUTPUT $t_{DVDD}; V_{DD}$ Power On Delay $t_{DVSS}; V_{SS}$ Power-On Delay | | 10 1000 | | μs μs | $R_L = 1\text{k}\Omega$ $R_L = 1\text{k}\Omega$ |
| SP784 OUTPUT DELAY TIME | | | | | |
| t_{SD1} ; Switching Delay from $\pm 10\text{V}$ to $\pm 5\text{V}$ | | 10 | | ms | $R_L = 1\text{k}\Omega$ |
| t_{SD2} ; Switching Delay from $\pm 5\text{V}$ to $\pm 10\text{V}$ | | 2 | | ms | $R_L = 1\text{k}\Omega$ |

* - Using the charge pump capacitor values specified in the previous pages for each device.

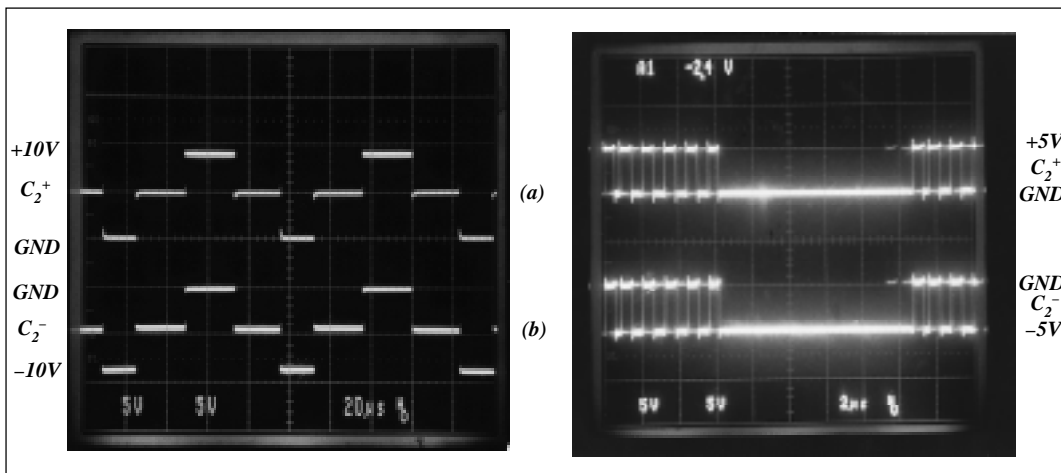
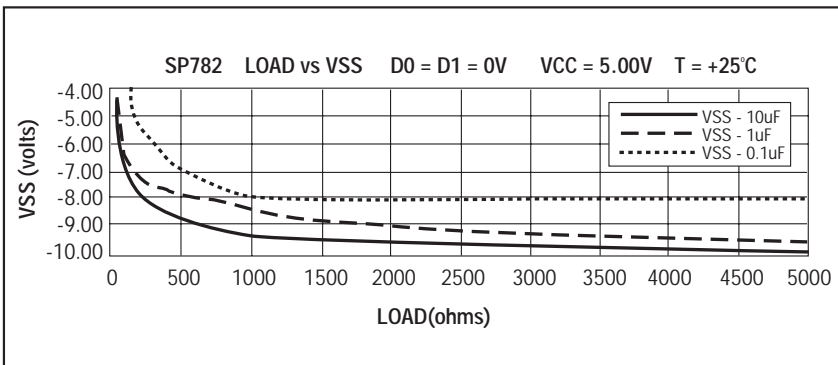
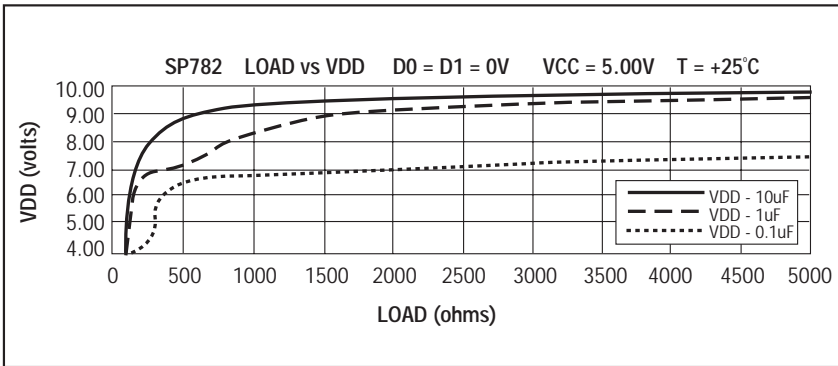
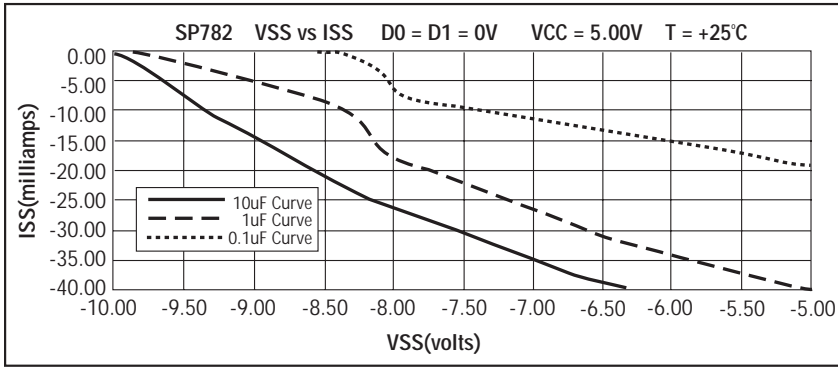
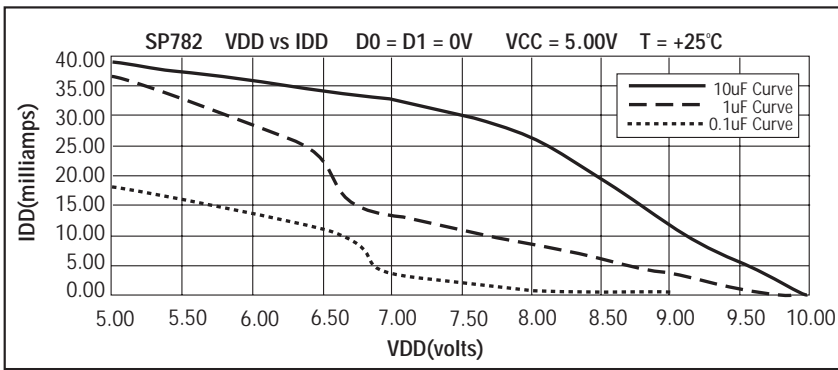
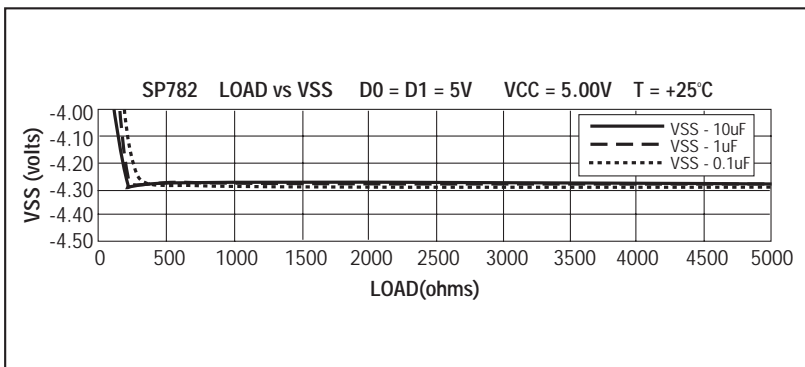
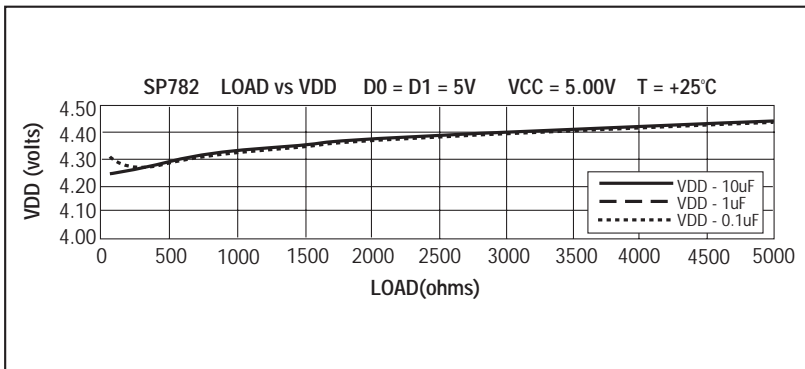
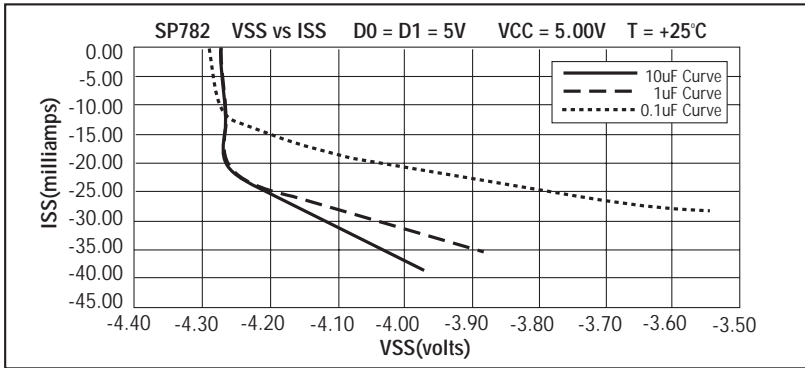
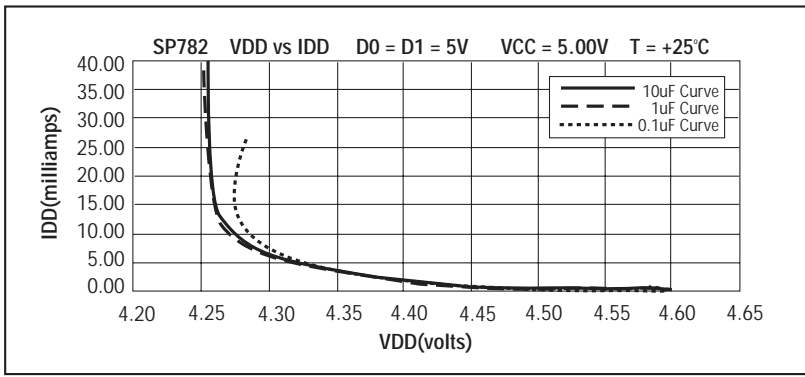
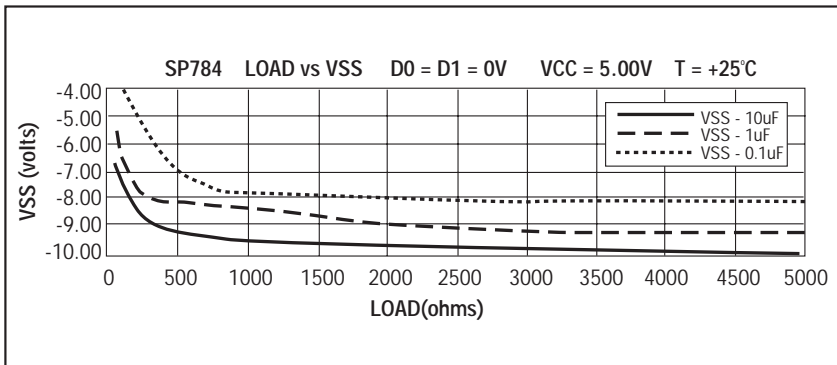
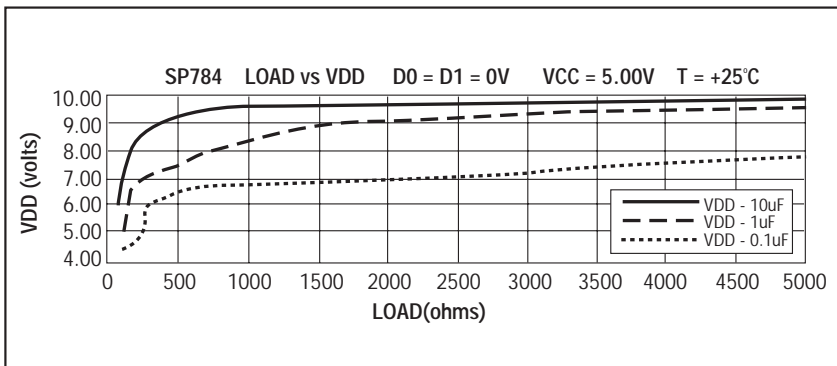
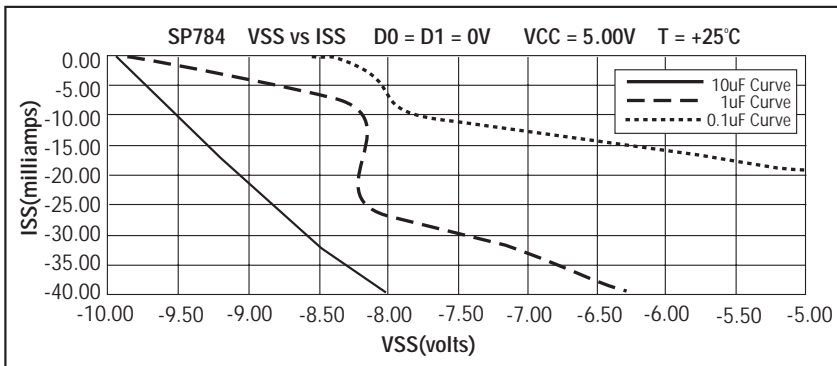
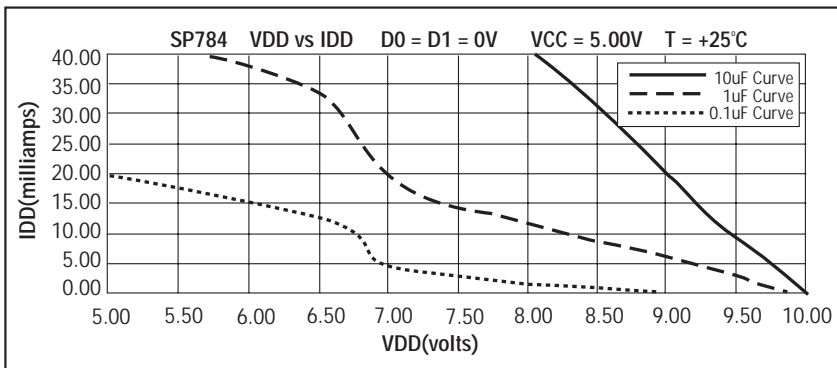
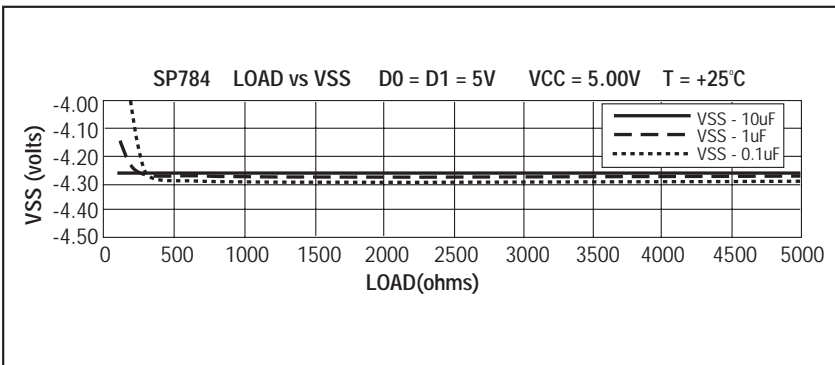
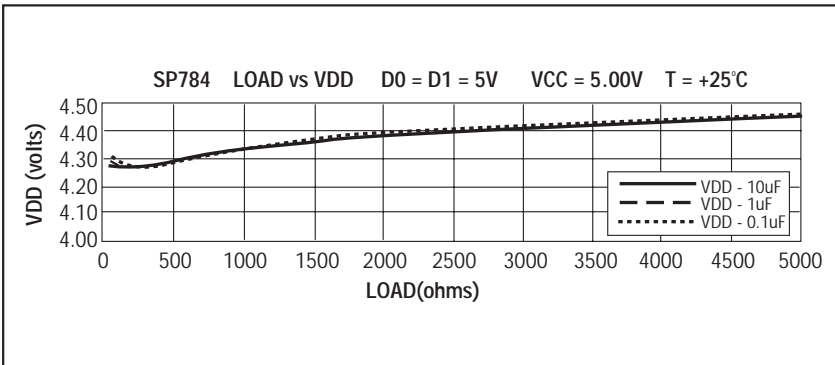
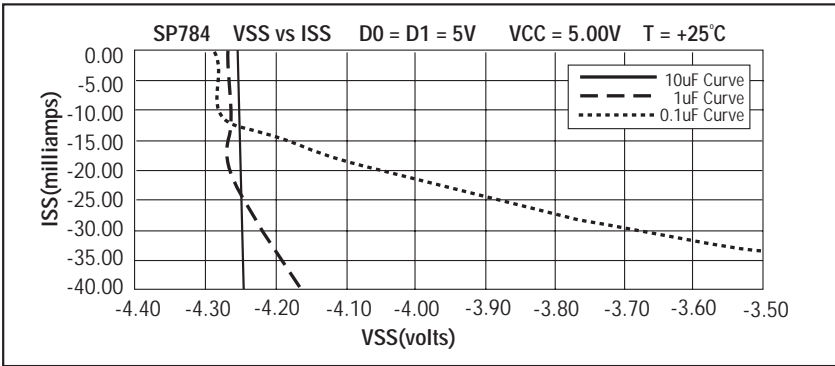
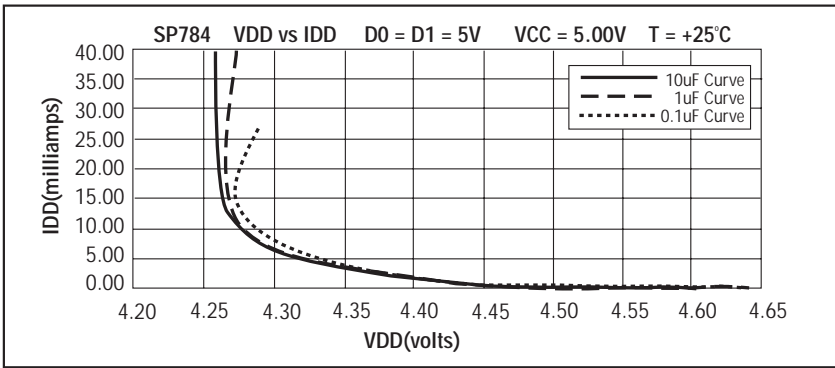

Figure 1. Charge Pump Waveforms









THEORY OF OPERATION

The **SP782/784's** charge pump design is based on **Sipex's** original patented charge pump design (5,306,954) which uses a four-phase voltage shifting technique to attain symmetrical 10V power supplies. In addition, the **SP782/784** charge pump incorporates a "programmable" feature that produces an output of $\pm 10V$ or $\pm 5V$ for V_{SS} and V_{DD} by two control pins, D0 and D1. The charge pump requires external capacitors to store the charge. Figure 1 shows the waveform found on the positive and negative side of capacitor C2. There is a free-running oscillator that controls the four phases of the voltage shifting. A description of each phase follows.

Phase 1 ($\pm 10V$)

— V_{SS} charge storage — During this phase of the clock cycle, the positive side of capacitors C_1 and C_2 are initially charged to +5V. C_1^+ is then switched to ground and the charge on C_1^- is transferred to C_2^- . Since C_2^+ is connected to +5V, the voltage potential across capacitor C_2 is now 10V.

Phase 1 ($\pm 5V$)

— V_{SS} & V_{DD} charge storage and transfer — With the C_1 and C_2 capacitors initially charged to +5V, C_1^+ is then switched to ground and the charge on C_1^- is transferred to the V_{SS} storage capacitor. Simultaneously the C_2^- is switched to ground and 5V charge on C_2^+ is transferred to the V_{DD} storage capacitor.

Phase 2 ($\pm 10V$)

— V_{SS} transfer — Phase two of the clock connects the negative terminal of C_2 to the V_{SS} storage capacitor and the positive terminal of C_2 to ground, and transfers the generated -10V or the generated -5V to C_3 . Simultaneously, the positive side of capacitor C_1 is switched to +5V and the negative side is connected to ground.

Phase 2 ($\pm 5V$)

— V_{SS} & V_{DD} charge storage — C_1^+ is reconnected to V_{CC} to recharge the C_1 capacitor. C_2^+ is switched to ground and C_2^- is connected to C_3 . The 5V charge from Phase 1 is now transferred to the V_{SS} storage capacitor.

V_{SS} receives a continuous charge from either C_1 or C_2 . With the C_1 capacitor charged to 5V, the cycle begins again.

Phase 3

— V_{DD} charge storage — The third phase of the clock is identical to the first phase — the charge transferred in C_1 produces -5V in the negative terminal of C_1 , which is applied to the negative side of capacitor C_2 . Since C_2^+ is at +5V, the voltage potential across C_2 is 10V. For the 5V output, C_2^+ is connected to ground so that the potential on C_2 is only +5V.

Phase 4

— V_{DD} transfer — The fourth phase of the clock connects the negative terminal of C_2 to ground and transfers the generated 10V or the generated 5V across C_2 to C_4 , the V_{DD} storage capacitor. Again, simultaneously with this, the positive side of capacitor C_1 is switched to +5V and the negative side is connected to ground, and the cycle begins again.

Since both V_{DD} and V_{SS} are separately generated from V_{CC} in a no-load condition, V_{DD} and V_{SS} will be symmetrical. Older charge pump approaches that generate V^- from V^+ will show a decrease in the magnitude of V^- compared to V^+ due to the inherent inefficiencies in the design.

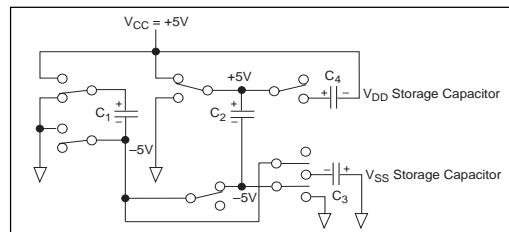

Figure 2. Charge Pump Phase 1 for $\pm 10V$.

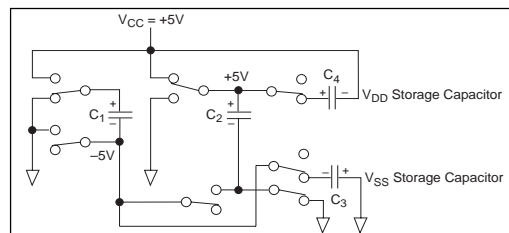

Figure 3. Charge Pump Phase 1 for $\pm 5V$.

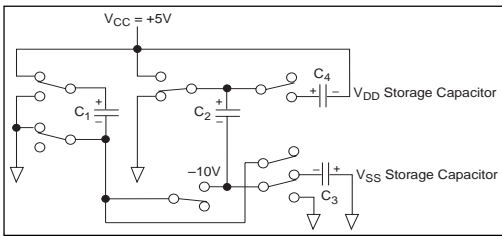

Figure 4. Charge Pump Phase 2 for ±10V.

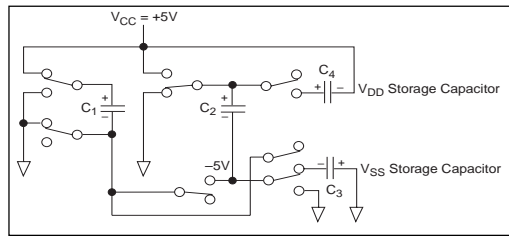

Figure 5. Charge Pump Phase 2 for ±5V.

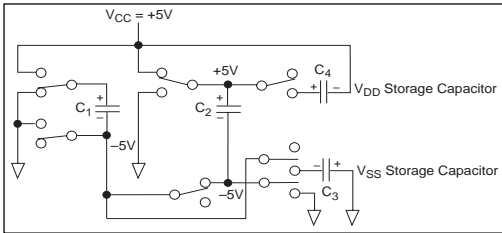

Figure 6. Charge Pump Phase 3.

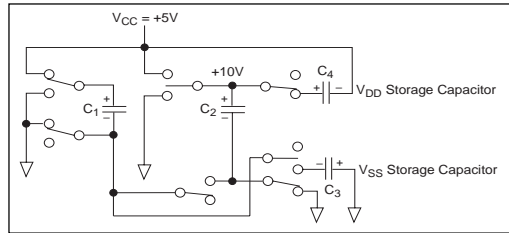

Figure 7. Charge Pump Phase 4.

The oscillator frequency or clock rate for the charge pump is designed for low power operation. The oscillator changes from a high frequency mode (400kHz) to a low frequency mode (20kHz) when the SD pin goes to a logic "1". The lower frequency allows the **SP782/SP784** to conserve power when the outputs are not being used.

EFFICIENCY INFORMATION

A charge pump theoretically produces a doubled voltage at 100% efficiency. However in the real world, there is a small voltage drop on the output which reduces the output efficiency. The **SP782** and **SP784** can usually run 99.9% efficient without driving a load. While driving a 1kΩ load, the **SP782** and **SP784** remain at least 90% efficient.

$$\begin{aligned} \text{Total Output Voltage Efficiency} &= \\ &= [(V_{\text{OUT}+}) / (2 * V_{\text{CC}})] + [(V_{\text{OUT}-}) / (-2 * V_{\text{CC}})]; \\ V_{\text{OUT}+} &= 2 * V_{\text{CC}} + V_{\text{DROP}+} \\ V_{\text{OUT}-} &= -2 * V_{\text{CC}} + V_{\text{DROP}-} \\ V_{\text{DROP}-} &= (I-) * (R_{\text{OUT}-}) \\ V_{\text{DROP}+} &= (I+) * (R_{\text{OUT}+}) \\ \text{Power Loss} &= I_{\text{OUT}} * (V_{\text{DROP}}) \end{aligned}$$

The efficiency changes as the external charge pump capacitors are varied. Larger capacitor values will strengthen the output and reduce output ripple usually found in all charge pumps. Although smaller capacitors will cost less and

save board space, lower values will reduce the output drive capability.

The output voltage ripple is also affected by the capacitors, specifically C3 and C4. Larger values will reduce the output ripple for a given load of current. The current drawn from either output is supplied by just the storage capacitor, C3 or C4, during one half cycle of the internal oscillator. Note that the output current from the positive charge pump is the load current plus the current taken by the negative charge pump. Thus the formula representation for the output ripple voltage is:

$$\begin{aligned} V_{\text{RIPPLE}+} &= \{1 / (f_{\text{OSC}}) * 1 / C3\} * 0.5 * I_{\text{OUT}+} \\ V_{\text{RIPPLE}-} &= \{1 / (f_{\text{OSC}}) * 1 / C3\} * 0.5 * I_{\text{OUT}-} \end{aligned}$$

To minimize the output ripple, the C3 and C4 storage capacitors can be increased to over 10μF whereas the pump capacitors can range from 1μF to 5μF.

Multiple **SP782/784** charge pumps can be connected in parallel. However, the output resistance on both pump outputs will be reduced. The effective output resistance is the output resistance of one pump divided by the number of charge pumps connected. It is important to keep the C1 and C2 capacitors separate for each charge pump. The storage capacitors, C3 and C4, can be shared.

SHUTDOWN MODE

The internal oscillator of the **SP782** and **SP784** can be shutdown through the SD pin. In this state, the V_{DD} and V_{SS} outputs are inactive and the power supply current reduces to $10\mu\text{A}$.

LATCH ENABLE PIN

The **SP782** and **SP784** includes a control pin (LAT) that latches the D0 and D1 control lines. Connecting this pin to a logic HIGH state will allow transparent operation of the D0 and D1 control lines. This input can be left floating since there is an internal pull-up resistor which will allow the latch to be transparent.

APPLICATIONS INFORMATION

The **SP782** and **SP784** can be used in various applications where $\pm 10\text{V}$ is needed from a $+5\text{V}$ source. Analog switches, op-amp power supplies, and LCD biasing are some applications where the charge pumps can be used.

The charge pump can also be used for supplying voltage rails for RS-232 drivers needing $\pm 12\text{V}$. The $\pm 10\text{V}$ output from the charge pump is more than adequate to provide the proper V_{OH} and V_{OL} levels at the driver output.

Figure 8 shows how the **SP784** can be used in conjunction with the SP524 multiprotocol transceiver IC. The programmability is ideal for RS-232 and RS-423 levels. The RS-232 driver output voltage swing ranges from $\pm 5\text{V}$ to $\pm 15\text{V}$. In order to meet this requirement, the charge pump must generate $\pm 10\text{V}$ to the transceiver IC.

The RS-423 driver output voltage range is $\pm 4.0\text{V}$ to $\pm 6.0\text{V}$. When the SP524 transceiver is programmed to RS-423 mode (V.10), the charge pump now provides $\pm 5\text{V}$, through D0 and D1, thus allowing the driver outputs to comply with $V_{OC} \leq 6.0\text{V}$ as well as the V_T requirement of $\pm 4.0\text{V}$ minimum with a 450Ω load to ground.

In older configurations, separate DC sources needed to be configured or regulated down from $\pm 10\text{V}$ to $\pm 5\text{V}$ in a given application. A typical charge pump providing V_{DD} and V_{SS} would require external clamping such as 5V Zener diodes. RS-423 (V.10) is usually found in RS-449, EIA-530, EIA-530A, and V.36 modes.

When the control lines D0 and D1 are both at a logic HIGH, $V_{DD} = +5\text{V}$ and $V_{SS} = -5\text{V}$. All other inputs to the control lines result in $V_{DD} = +10\text{V}$ and $V_{SS} = -10\text{V}$. Control of the **SP784** in an application with Sipex's **SP524** can be found in *Figure 8*.

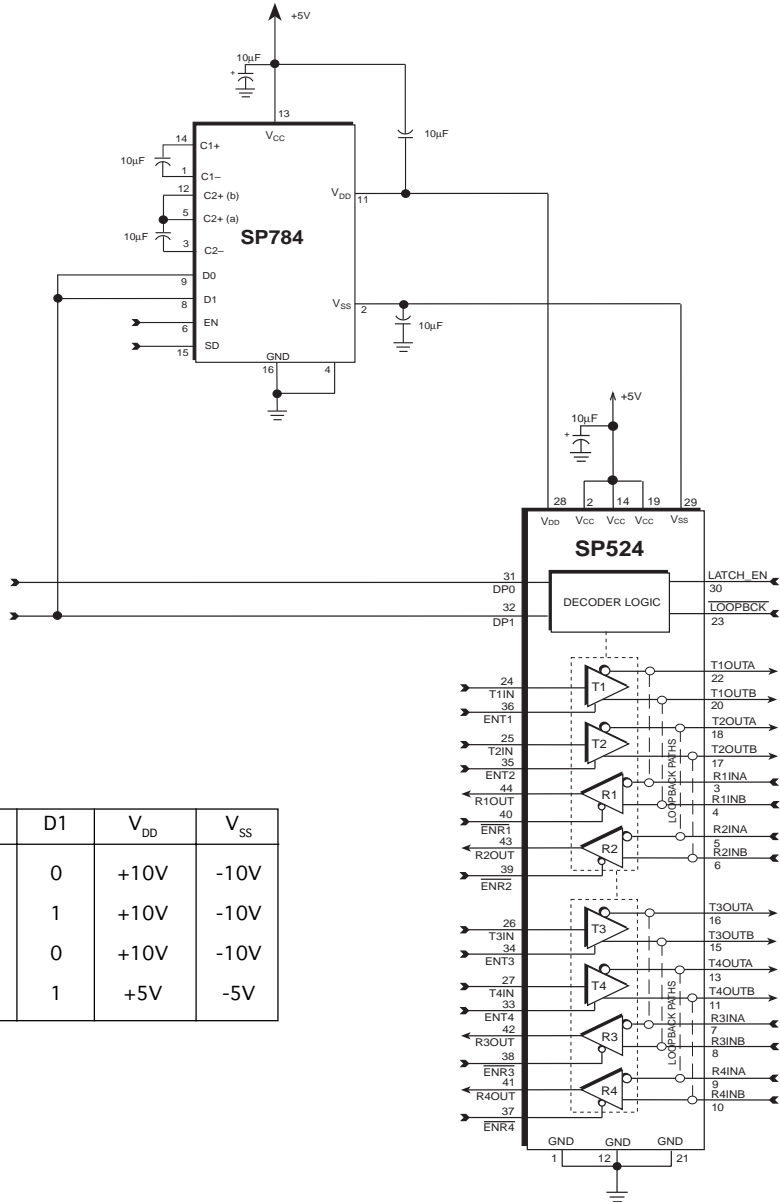

| D0 | D1 | V _{DD} | V _{SS} |
|----|----|-----------------|-----------------|
| 0 | 0 | +10V | -10V |
| 0 | 1 | +10V | -10V |
| 1 | 0 | +10V | -10V |
| 1 | 1 | +5V | -5V |

Figure 8. SP784 Application w/ SP524 Multi-Protocol Transceiver IC.

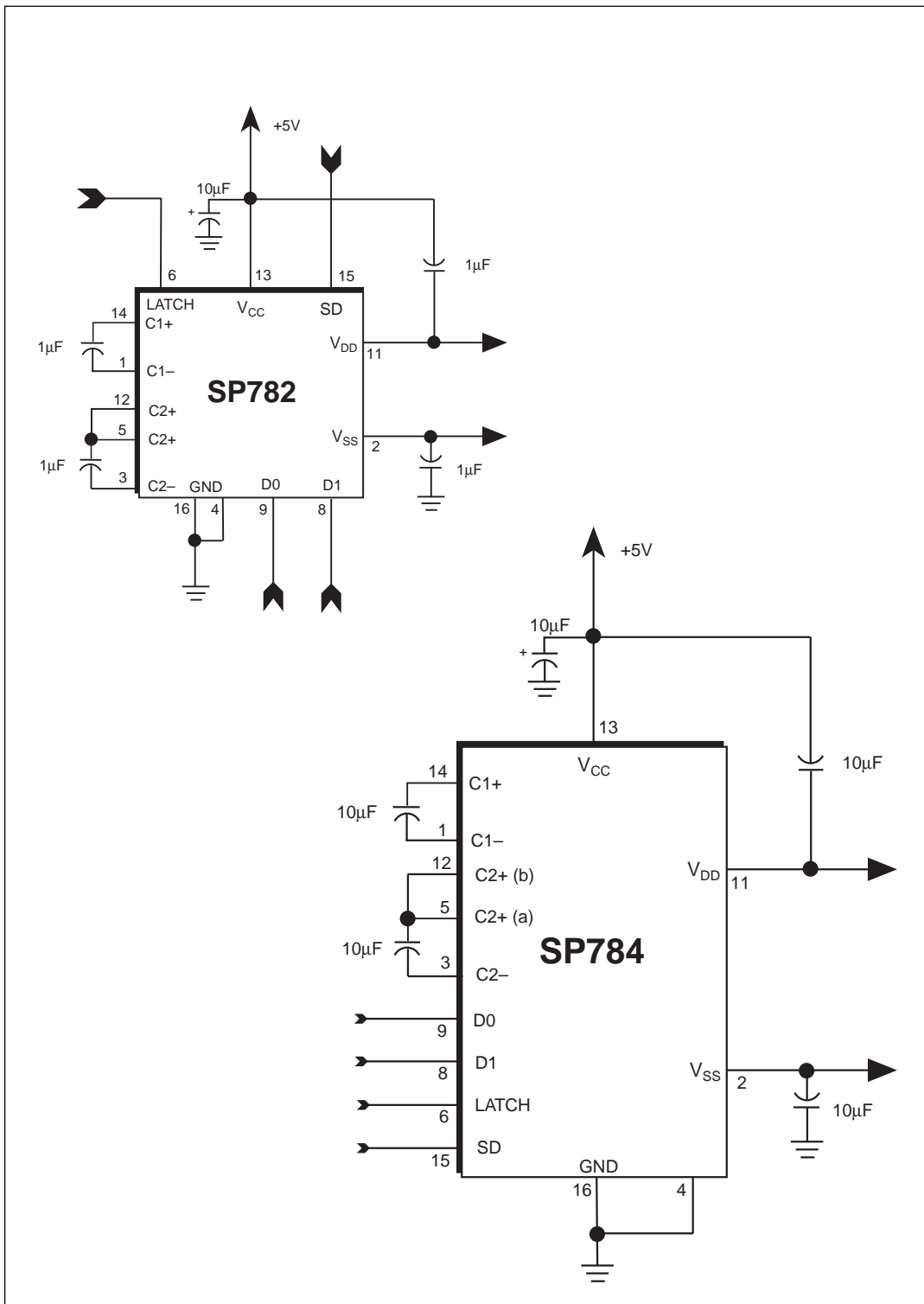
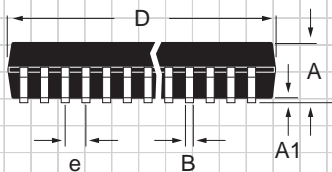
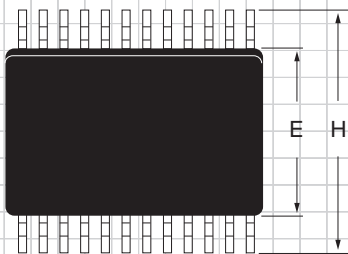

Figure 9. SP782 and SP784 Block Diagrams

**PACKAGE: PLASTIC
SMALL OUTLINE (SOIC)
(WIDE)**



| DIMENSIONS (Inches) Minimum/Maximum (mm) | 16-PIN |
|--|------------------------------|
| A | 0.093/0.104 (2.352/2.649) |
| A1 | 0.004/0.012 (0.102/0.300) |
| B | 0.013/0.020 (0.330/0.508) |
| D | 0.398/0.406 (10.11/10.31) |
| E | 0.291/0.299 (7.402/7.600) |
| e | 0.050 BSC (1.270 BSC) |
| H | 0.394/0.419 (10.00/10.64) |
| L | 0.016/0.050 (0.406/1.270) |
| Ø | 0°/8° (0°/8°) |

PACKAGE: 16-PIN PLASTIC DUAL-IN-LINE (NARROW)

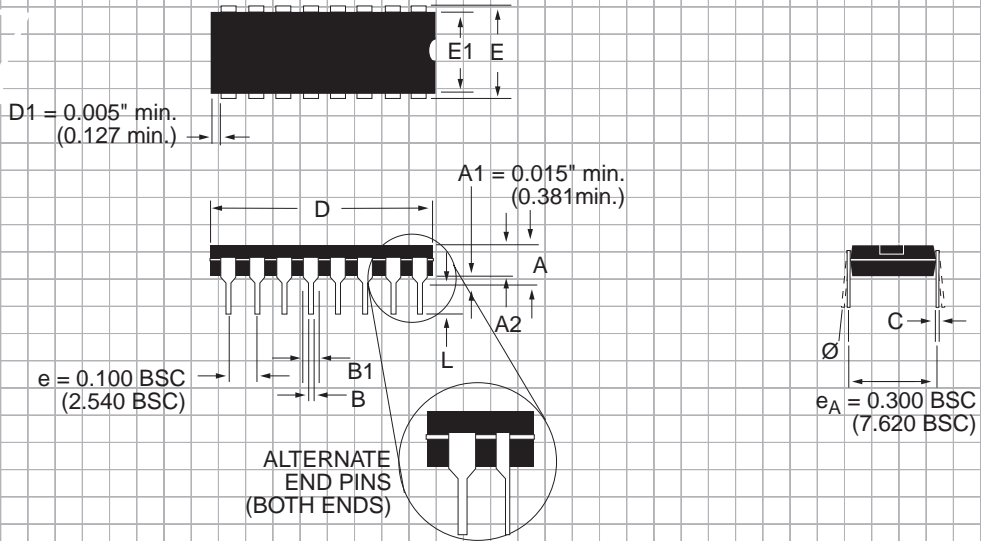

| DIMENSIONS (Inches) Minimum/Maximum (mm) | 16-PIN |
|--|--------------------------------|
| A | −0.210 (−5.334) |
| A2 | 0.115/0.195 (2.921/4.953) |
| B | 0.014/0.022 (0.356/0.559) |
| B1 | 0.045/0.070 (1.143/1.778) |
| C | 0.008/0.014 (0.203/0.356) |
| D | 0.780/0.800 (19.812/20.320) |
| E | 0.300/0.325 (7.620/8.255) |
| E1 | 0.240/0.280 (6.096/7.112) |
| L | 0.115/0.150 (2.921/3.810) |
| ∅ | 0°/ 15° (0°/15°) |

ORDERING INFORMATION

| Model | Temperature Range | Package Types |
|---------------|--------------------|--------------------|
| SP782CP | 0°C to +70°C | 16-pin Plastic DIP |
| SP784CP | 0°C to +70°C | 16-pin Plastic DIP |
| SP782CT | 0°C to +70°C | 16-pin SOIC |
| SP784CT | 0°C to +70°C | 16-pin SOIC |

Please consult the factory for pricing and availability on a Tape-On-Reel option.



SIGNAL PROCESSING EXCELLENCE

Sipex Corporation

Headquarters and

Sales Office

22 Linnell Circle
Billerica, MA 01821
TEL: (978) 667-8700
FAX: (978) 670-9001
e-mail: sales@sipex.com

Sales Office

233 South Hillview Drive
Milpitas, CA 95035
TEL: (408) 934-7500
FAX: (408) 935-7600

Sipex Corporation reserves the right to make changes to any products described herein. Sipex does not assume any liability arising out of the application or use of any product or circuit described herein; neither does it convey any license under its patent rights nor the rights of others.