

**100mW High Power Laser Diode**

**Description**

The SLD301XT allows independent thermal and electric design.

This laser diode has a built-in TE (Thermo Electric) cooler.

**Features**

- High power  
Recommended optical power output  $P_o = 90\text{mW}$
- Low operating current
- Flat Package with built-in photodiode, TE cooler and thermistor

**Applications**

- Solid state laser excitation
- Medical use

**Structure**

AlGaAs double-hetero-type laser diode

**Operating Lifetime**

MTTF 10,000H (effective value) at  $P_o = 90\text{mW}$ ,  $T_{th} = 25^\circ\text{C}$

**Absolute Maximum Ratings** ( $T_{th} = 25^\circ\text{C}$ )

- Optical power output  $P_{o\text{max}}$  100 mW
- Reverse voltage  $V_R$  LD 2 V

**Warranty**

This warranty period shall be 90 days after receipt of the product or 1,000 hours operation time whichever is shorter.

Sony Quality Assurance Department shall analyze any product that fails during said warranty period, and if the analysis results show that the product failed due to material or manufacturing defects on the part of Sony, the product shall be replaced free of charge.

Laser diodes naturally have differing lifetimes which follow a Weibull distribution.

Special warranties are also available.

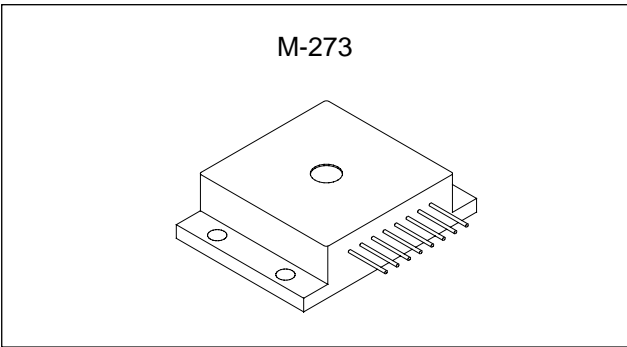

**Equivalent Circuit**

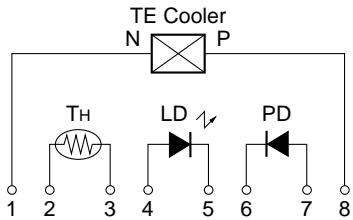

**Pin Configuration (Top View)**

No.	Function
1	TE cooler (negative)
2	Thermistor lead 1
3	Thermistor lead 2
4	Laser diode (anode)
5	Laser diode (cathode)
6	Photodiode (cathode)
7	Photodiode (anode)
8	TE cooler (positive)

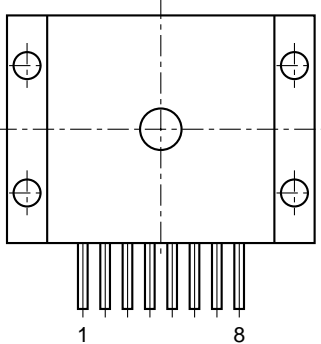

Sony reserves the right to change products and specifications without prior notice. This information does not convey any license by any implication or otherwise under any patents or other right. Application circuits shown, if any, are typical examples illustrating the operation of the devices. Sony cannot assume responsibility for any problems arising out of the use of these circuits.

**Electrical and Optical Characteristics**

(Tth: Thermistor temperature, Tth = 25°C)

Item	Symbol	Conditions	Min.	Typ.	Max.	Unit	
Threshold current	Ith			150	200	mA	
Operating current	Iop	P <sub>O</sub> = 90mW		250	400	mA	
Operating voltage	Vop	P <sub>O</sub> = 90mW		1.9	3.0	V	
Wavelength*	λp	P <sub>O</sub> = 90mW	770		840	nm	
Monitor current	I <sub>mon</sub>	P <sub>O</sub> = 90mW V <sub>R</sub> = 10V		0.15		mA	
Radiation angle	Perpendicular	θ <sub>⊥</sub>	P <sub>O</sub> = 90mW		28	40	degree
	Parallel	θ <sub>//</sub>			12	17	degree
Positional accuracy	Position	ΔX, ΔY	P <sub>O</sub> = 90mW			±100	μm
	Angle	Δφ <sub>⊥</sub>				±3	degree
Differential efficiency	η <sub>D</sub>	P <sub>O</sub> = 90mW	0.65	0.9		mW/mA	
Thermistor resistance	R <sub>th</sub>	T <sub>th</sub> = 25°C		10		kΩ	

**\* Wavelength Selection Classification**

Type	Wavelength (nm)
SLD301XT-1	785 ± 15
SLD301XT-2	810 ± 10
SLD301XT-3	830 ± 10

Type	Wavelength (nm)
SLD301XT-21	798 ± 3
SLD301XT-24	807 ± 3
SLD301XT-25	810 ± 3

Example of Representative Characteristics

Optical power output vs. Forward current characteristics

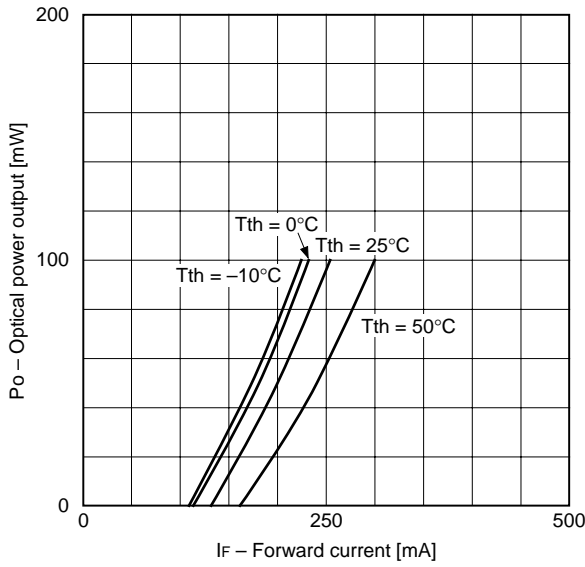

Optical power output vs. Monitor current characteristics

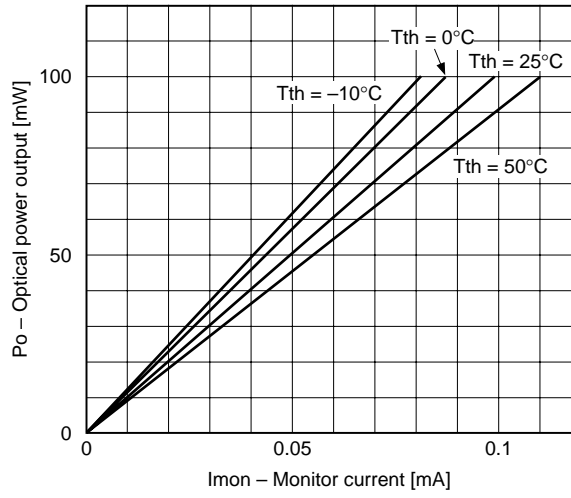

Threshold current vs. Temperature characteristics

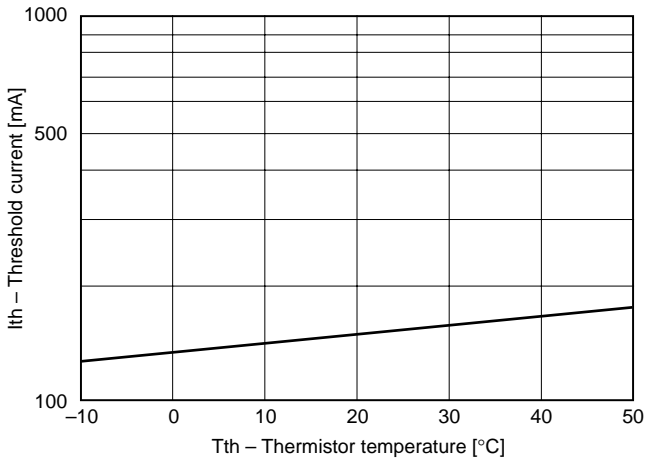

Power dependence of far field pattern (parallel to junction)

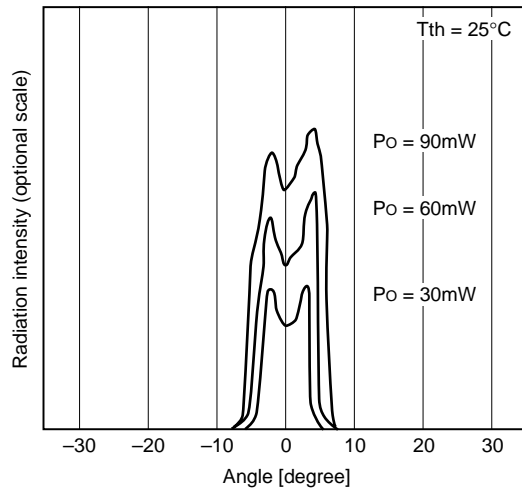

Power dependence of near field pattern

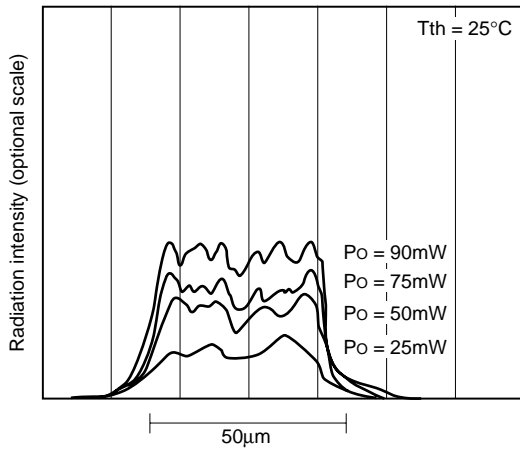

Oscillation wavelength vs. Temperature characteristics

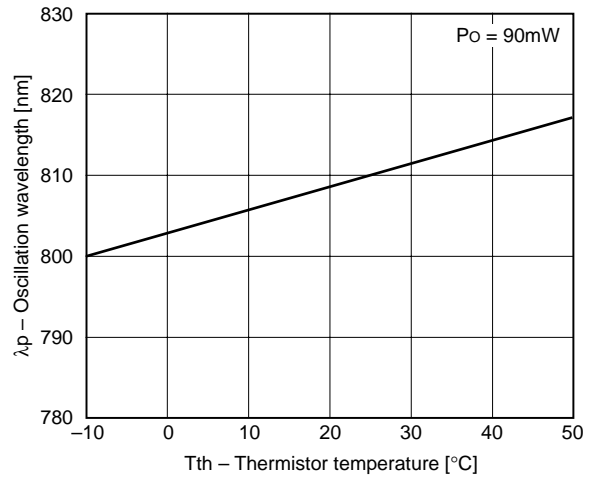

Differential efficiency vs. Temperature characteristics

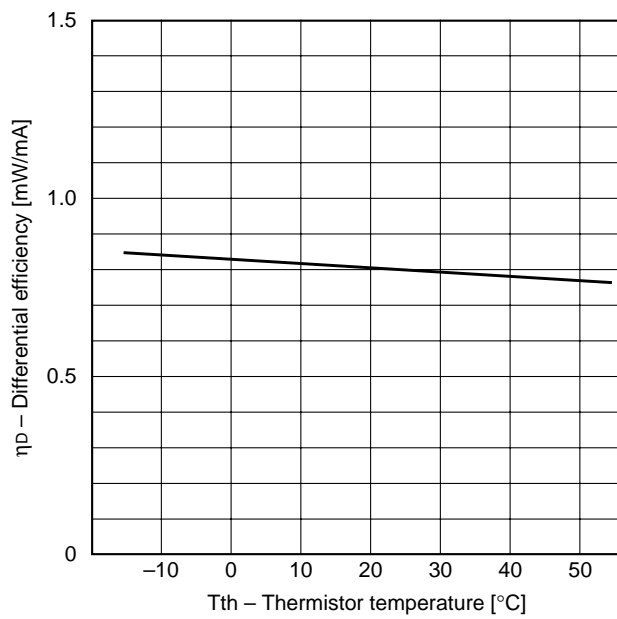

Power dependence of polarization ratio

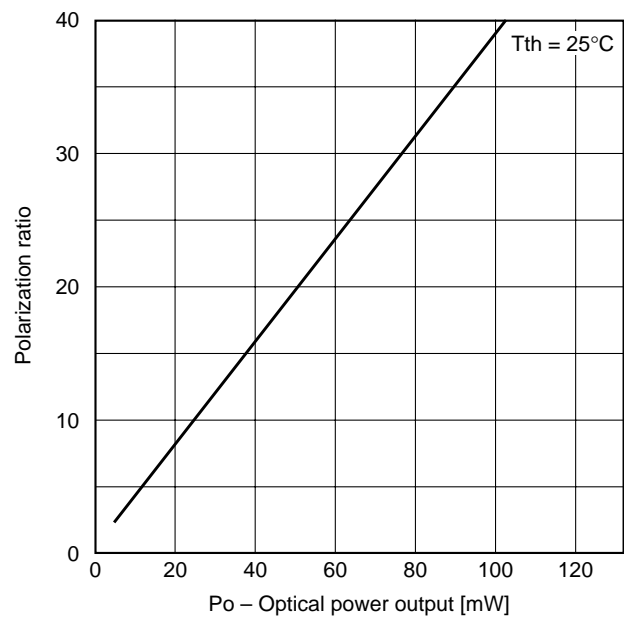

Power dependence of wavelength

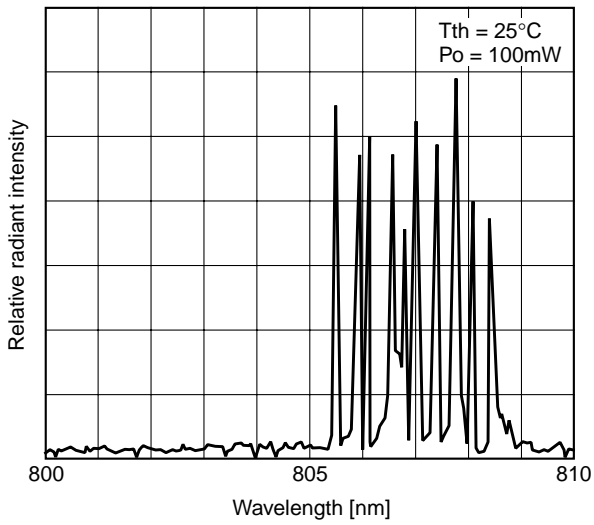
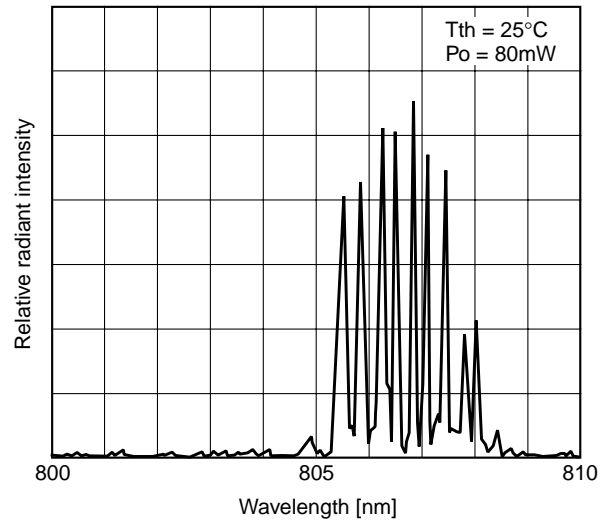
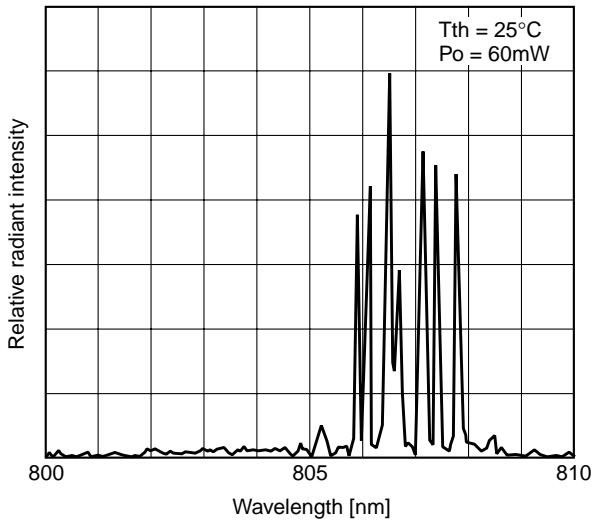
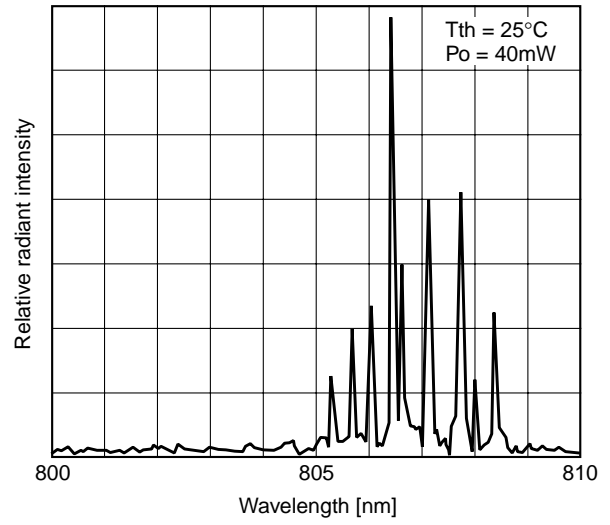
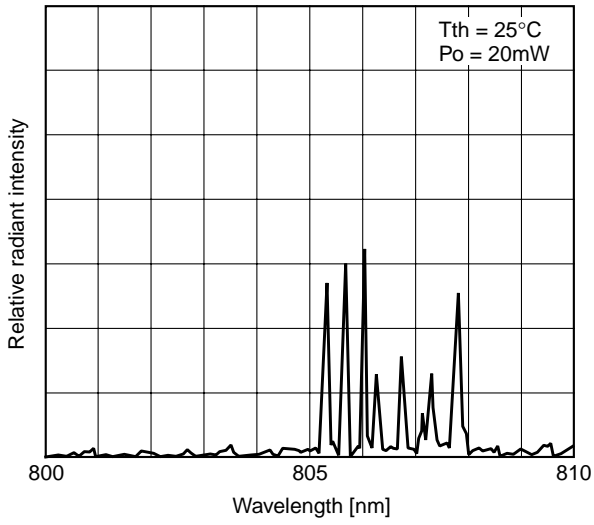

Temperature dependence of wavelength ( $P_o = 90\text{mW}$ )

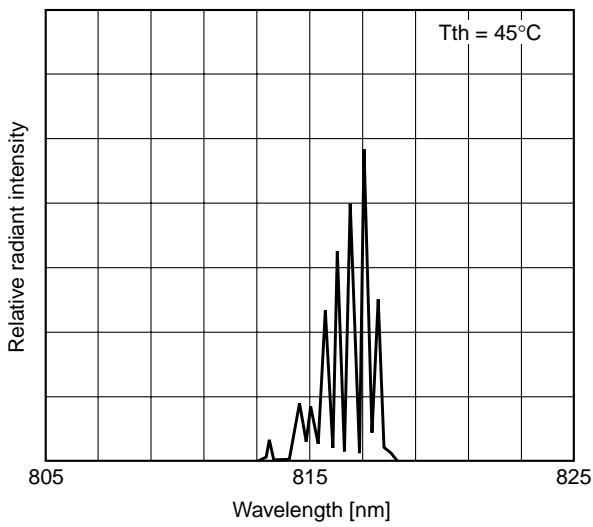
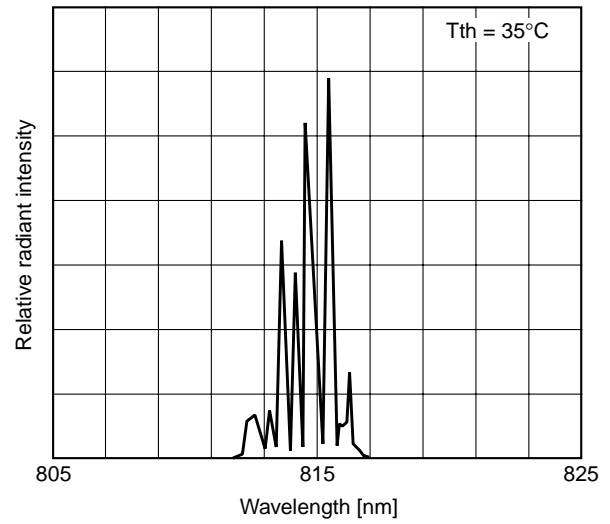
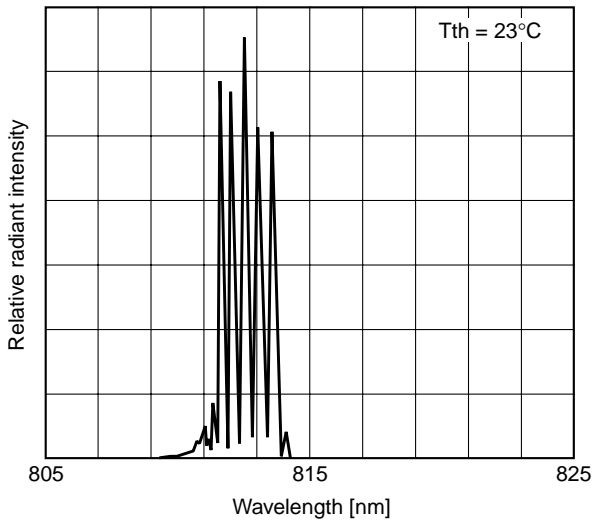
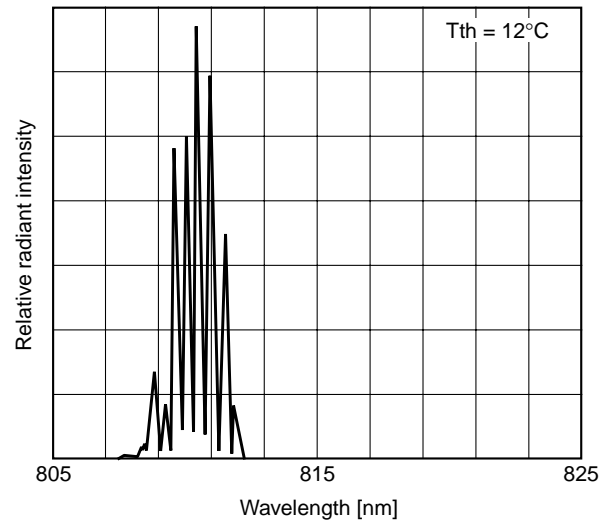
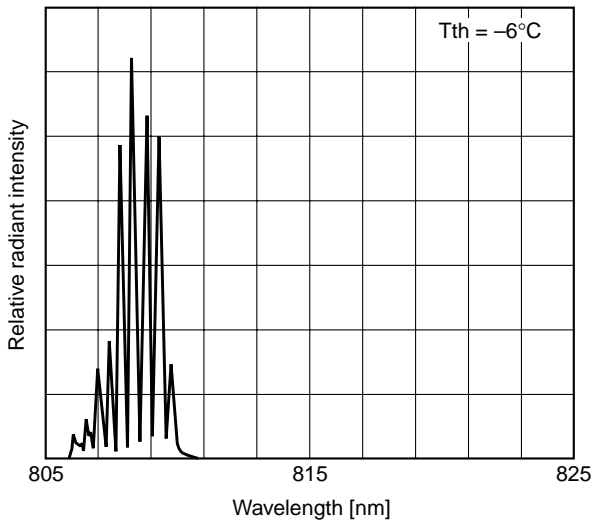

TE cooler characteristics

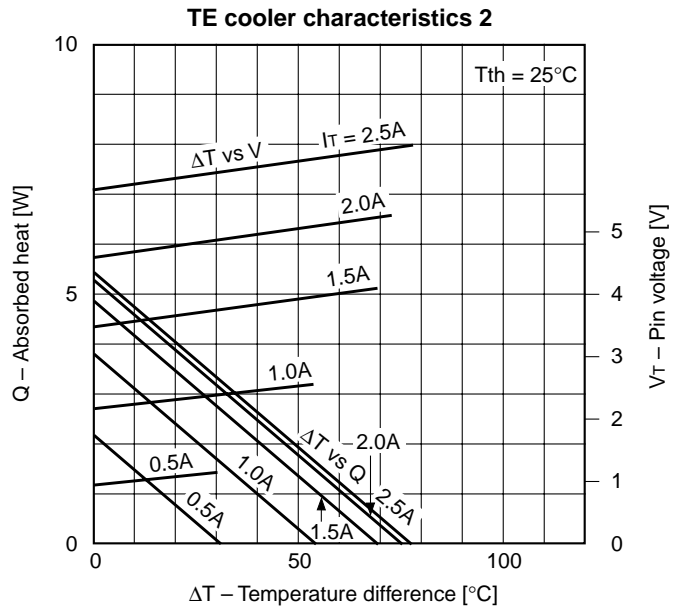
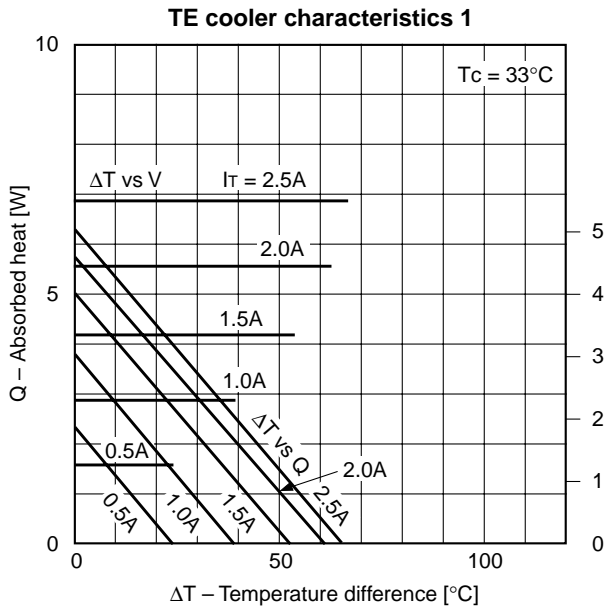

$\Delta T$  :  $T_c - T_{th}$   
 $T_{th}$  : Thermistor temperature  
 $T_c$  : Case temperature

Thermistor characteristics

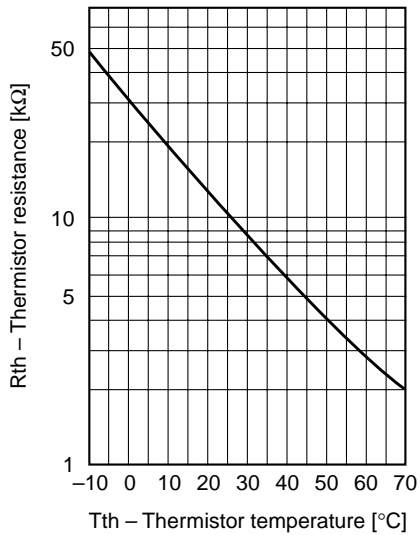

## Notes on Operation

Care should be taken for the following points when using this product.

- (1) This product corresponds to a Class 4 product under IEC60825-1 and JIS standard C6802 "Laser Product Emission Safety Standards".

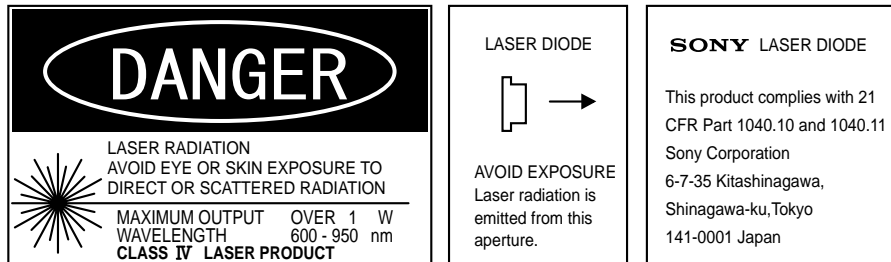

- (2) Eye protection against laser beams

Take care not to allow laser beams to enter your eyes under any circumstances.

For observing laser beams, ALWAYS use safety goggles that block laser beams. Usage of IR scopes, IR cameras and fluorescent plates is also recommended for monitoring laser beams safely.

- (3) Gallium Arsenide

This product uses gallium arsenide (GaAs). This is not a problem for normal use, but GaAs vapors may be potentially hazardous to the human body. Therefore, never crush, heat to the maximum storage temperature or higher, or place the product in your mouth.

In addition, the following disposal methods are recommended when disposing of this product.

1. Engaging the services of a contractor certified in the collection, transport and intermediate treatment of items containing arsenic.
2. Managing the product through to final disposal as specially managed industrial waste which is handled separately from general industrial waste and household waste.

- (4) Prevention of surge current and electrostatic discharge

Laser diodes are most sensitive to electrostatic discharge among semiconductors. When a large current is passed through the laser diode for even an extremely short time, the strong light emitted from the laser diode promotes deterioration and then destruction of the laser diode. Therefore, note that surge current should not flow to the laser diode driving circuit from switches and others. Also, if the laser diode is handled carelessly, it may be destroyed instantly because electrostatic discharge is easily applied by a human body. Therefore, be extremely careful about overcurrent and electrostatic discharge.

- (5) Use for special applications

This product is not designed or manufactured for use in equipment used under circumstances where failure may pose a risk to life and limb, or result in significant material damage, etc.

Consult your Sony sales representative when investigating use for medical, vehicle, nuclear power control or other special applications. Also, use the power supply that was designed not to exceed the optical power output specified at the absolute maximum ratings.



Package Outline

Unit: mm

M-273 (LO-10)

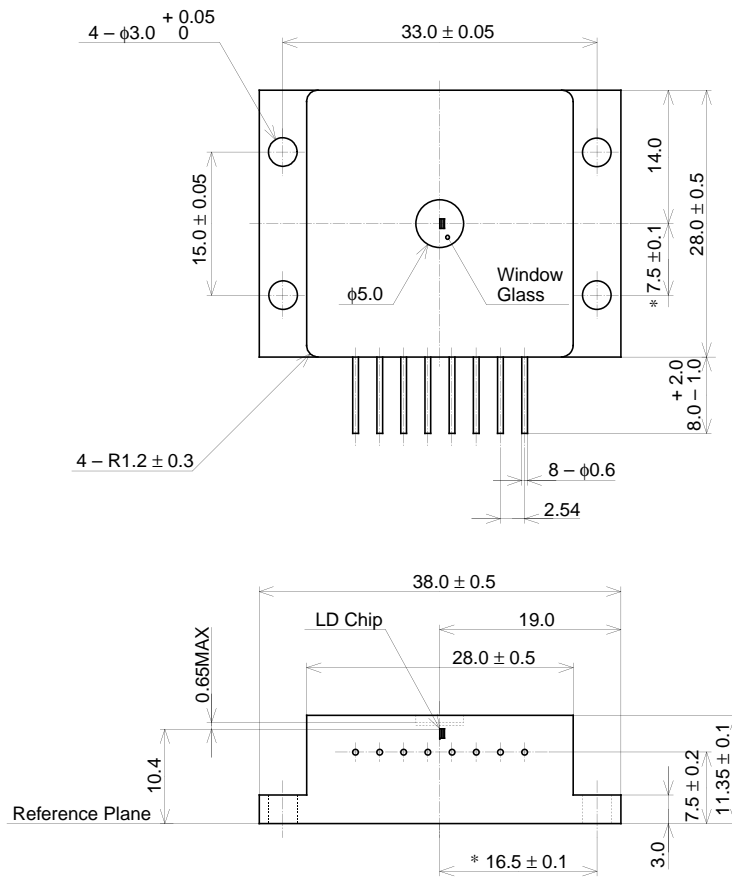

\*Distance between pilot hole and emitting area

PACKAGE STRUCTURE

SONY CODE	M-273(LO-10)
EIAJ CODE	_____
JEDEC CODE	_____

PACKAGE MASS	43g
--------------	-----