

HIGH EFFICIENCY ULTRAFAST DIODE

MAIN PRODUCT CHARACTERISTICS

$I_{F(AV)}$	Up to 2 x 15A
V_{RRM}	200 V
T_j (max)	175 °C
V_F (typ)	0.78 V
t_{rr} (typ)	22 ns

FEATURES AND BENEFITS

- Suited for SMPS
- Low losses
- Low forward and reverse recovery times
- Low leakage current
- High junction temperature
- Insulated package: TO-220FPAB

DESCRIPTION

Dual center tap rectifier suited for Switch Mode Power Supplies and High frequency DC to DC converters.

Packaged in TO-220AB, D²PAK, TO-220FPAB and I²PAK, this device is intended for use in low voltage, high frequency inverters, free wheeling and polarity protection applications.

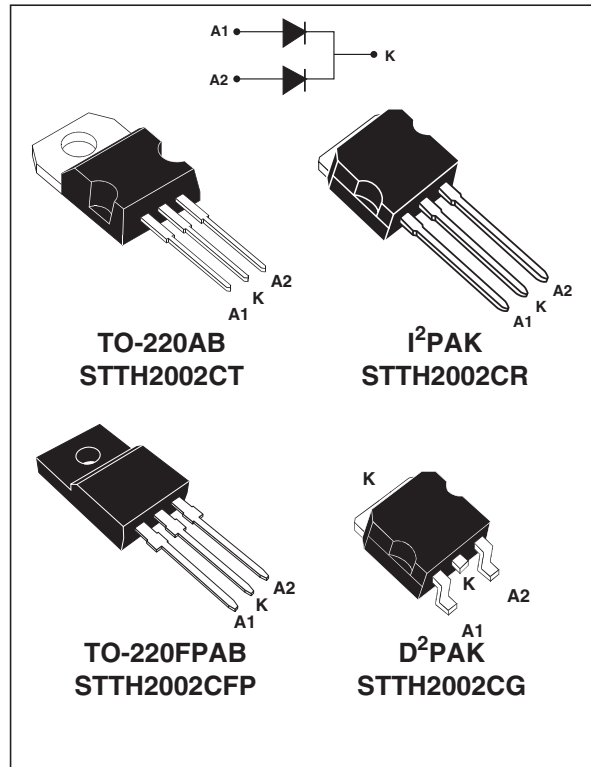

ABSOLUTE RATINGS (limiting values)

Symbol	Parameter		Value	Unit			
V_{RRM}	Repetitive peak reverse voltage		200	V			
$I_{F(RMS)}$	RMS forward current		30	A			
$I_{F(AV)}$	Average forward current $\delta = 0.5$	TO-220AB / I ² PAK / D ² PAK	Tc = 150°C	Per diode	10	A	
			Tc = 140°C	Per device	20		
			Tc = 130°C	Per diode	15		
			Tc = 115°C	Per device	30		
		TO-220FPAB		Tc = 120°C	Per diode		10
				Tc = 95°C	Per device		20
I_{FSM}	Surge non repetitive forward current		tp = 10 ms Sinusoidal	90	A		
T_{stg}	Storage temperature range		- 65 + 175		°C		
T_j	Maximum operating junction temperature		175		°C		

STTH2002C

THERMAL PARAMETERS

Symbol	Parameter		Maximum	Unit	
R _{th(j-c)}	Junction to case	TO-220AB / I ² PAK / D ² PAK	Per diode	2.5	°C/W
			Per device	1.6	
		TO-220FPAB	Per diode	5	
			Per device	3.8	
R _{th(j-c)}	Coupling	TO-220AB / I ² PAK / D ² PAK	0.7	°C/W	
		TO-220FPAB	2.5		

When the diodes 1 and 2 are used simultaneously:

$$\Delta T_j (\text{diode1}) = P(\text{diode1}) \times R_{th(j-c)} (\text{per diode}) + P(\text{diode2}) \times R_{th(c)}$$

STATIC ELECTRICAL CHARACTERISTICS (per diode)

Symbol	Parameter	Tests conditions		Min.	Typ.	Max.	Unit
I _R *	Reverse leakage current	T _j = 25°C	V _R = V _{RRM}			10	μA
		T _j = 125°C			6	100	
V _F **	Forward voltage drop	T _j = 25°C	I _F = 10 A			1.1	V
		T _j = 25°C	I _F = 20 A			1.25	
		T _j = 150°C	I _F = 10 A		0.78	0.89	
		T _j = 150°C	I _F = 20 A			1.05	

Pulse test: * t_p = 5ms, δ < 2%

** t_p = 380μs, δ < 2%

To evaluate the maximum conduction losses use the following equation :

$$P = 0.73 \times I_{F(AV)} + 0.016 I_{F(RMS)}^2$$

DYNAMIC ELECTRICAL CHARACTERISTICS

Symbol	Parameter	Tests conditions		Min.	Typ.	Max.	Unit
t _{rr}	Reverse recovery time	T _j = 25°C	I _F = 1 A V _R = 30V dI _F /dt = 100 A/μs		22	27	ns
I _{RM}	Reverse recovery current	T _j = 125°C	I _F = 10 A V _R = 160V dI _F /dt = 200 A/μs		7.0	9.0	A
t _{fr}	Forward recovery time	T _j = 25°C	I _F = 10 A dI _F /dt = 100 A/μs V _{FR} = 1.1 x V _{Fmax}			200	ns
V _{FP}	Forward recovery voltage	T _j = 25°C	I _F = 10 A dI _F /dt = 100 A/μs		2.4		V

Fig. 1: Peak current versus duty cycle (per diode).

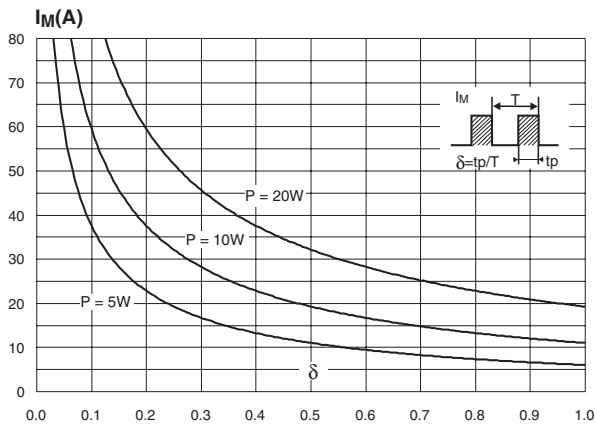

Fig. 2-1: Forward voltage drop versus forward current (typical values, per diode).

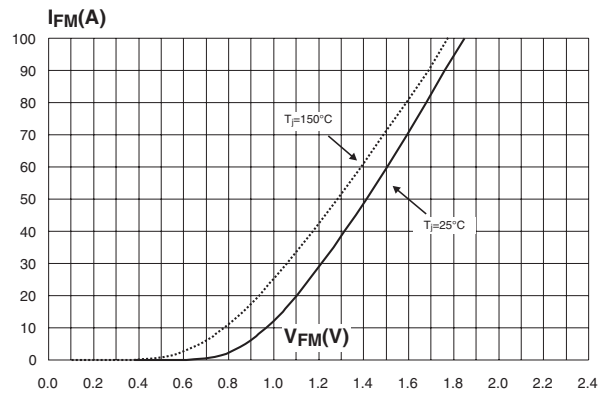

Fig. 2-2: Forward voltage drop versus forward current (maximum values, per diode).

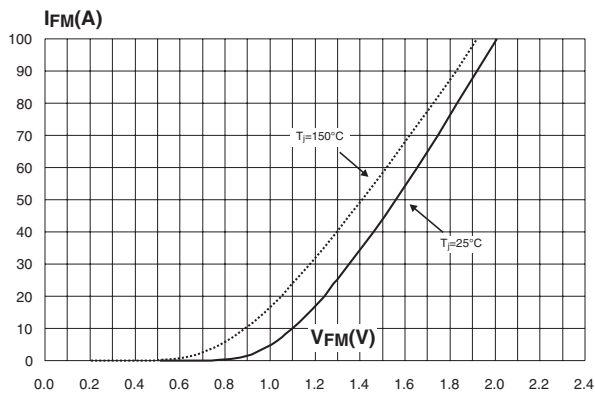

Fig. 3-1: Relative variation of thermal impedance junction to case versus pulse duration (TO-220AB, I²PAK, D²PAK).

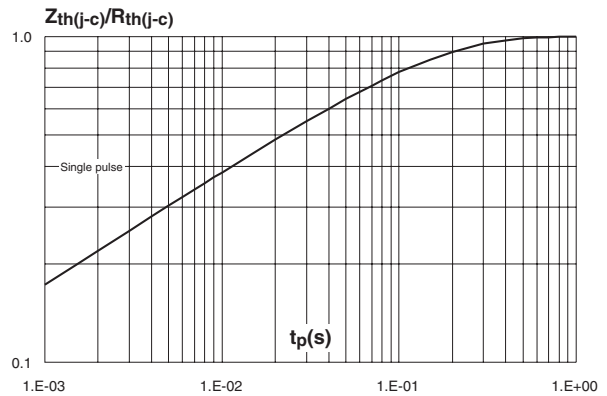

Fig. 3-2: Relative variation of thermal impedance junction to case versus pulse duration (TO-220FPAB).

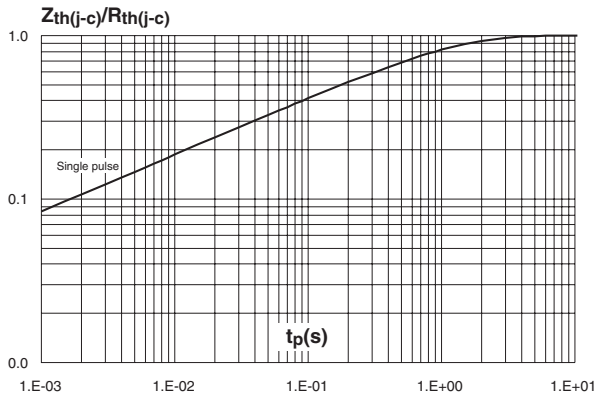

Fig. 4: Junction capacitance versus reverse voltage applied (typical values, per diode).

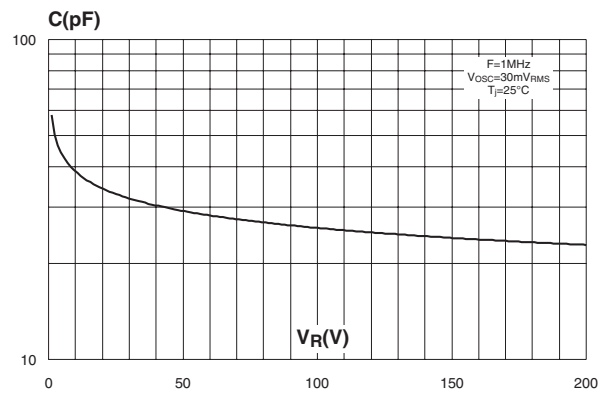

Fig. 5: Reverse recovery charges versus di_F/dt (typical values, per diode).

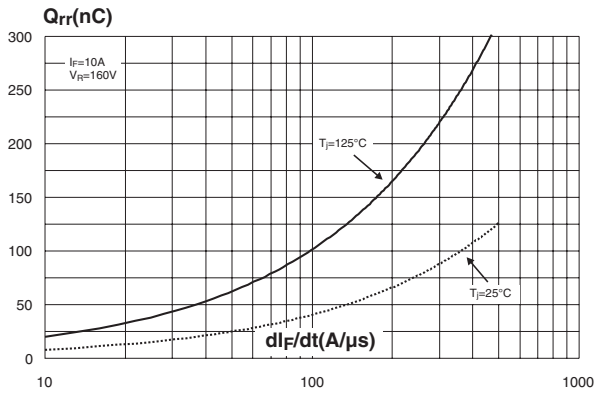

Fig. 6: Reverse recovery time versus di_F/dt (typical values, per diode).

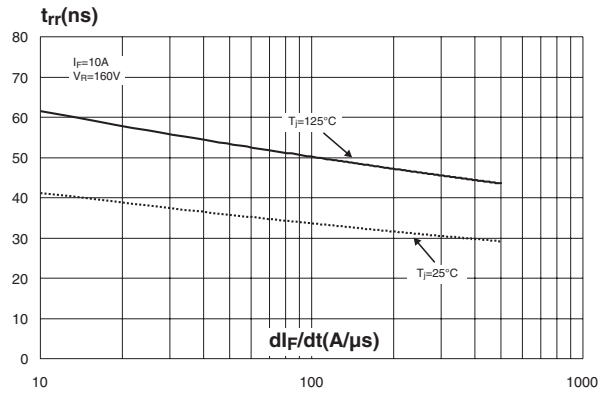

Fig. 7: Peak reverse recovery current versus di_F/dt (typical values, per diode).

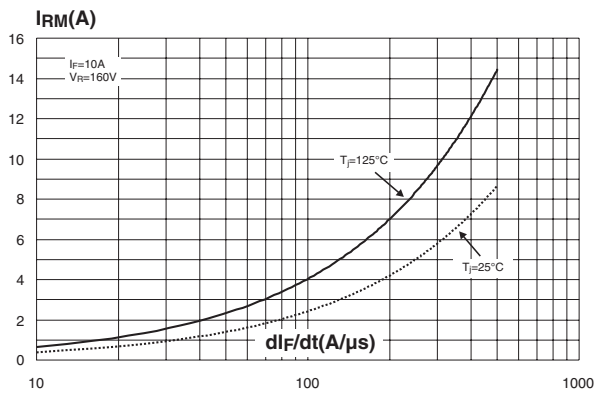

Fig. 8: Dynamic parameters versus junction temperature.

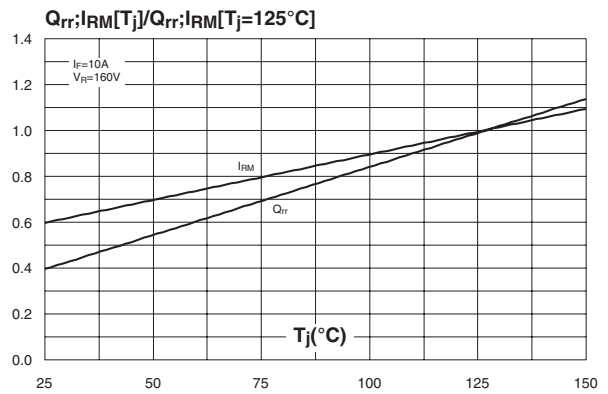
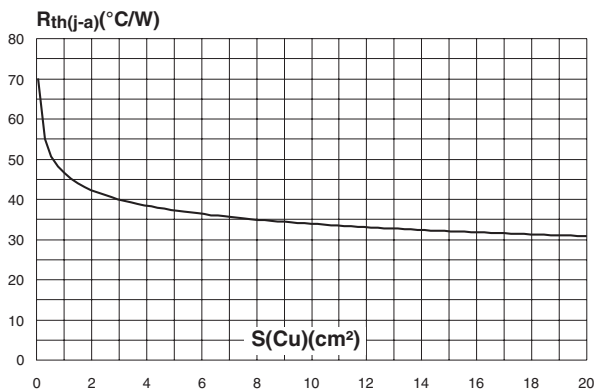
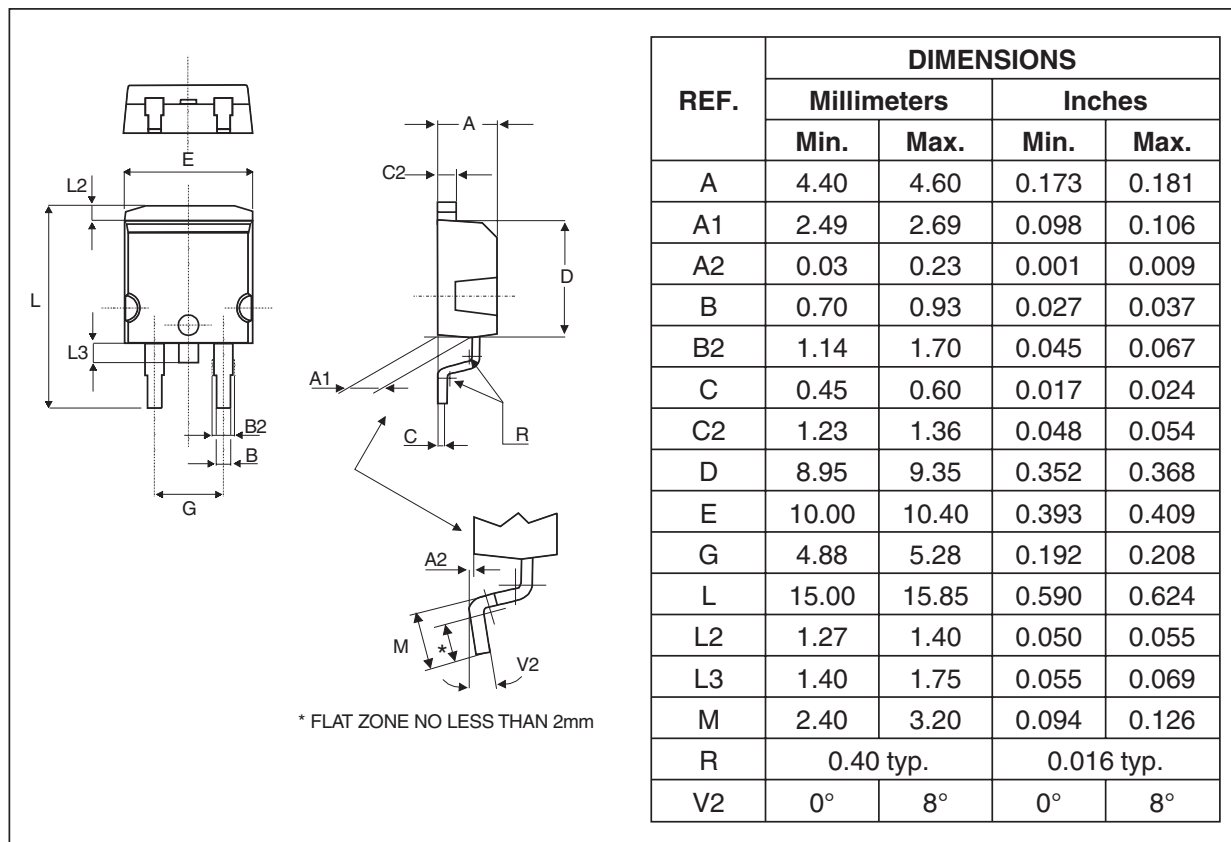

Fig. 9: Thermal resistance junction to ambient versus copper surface under tab (Epoxy printed circuit board FR4, ϵ_{cu} : 35μm) for D²PAK.



Ordering code	Marking	Package	Weight	Base qty	Delivery mode
STTH2002CT	STTH2002CT	TO-220AB	2.23 g	50	Tube
STTH2002CG	STTH2002CG	D ² PAK	1.48 g	50	Tube
STTH2002CG-TR	STTH2002CG	D ² PAK	1.48 g	1000	Tape & reel
STTH2002CR	STTH2002CR	I ² PAK	1.49 g	50	Tube
STTH2002CFP	STTH2002CFP	TO-220FPAB	1.70g	50	Tube

PACKAGE MECHANICAL DATA
D²PAK



FOOTPRINT DIMENSIONS (in millimeters)

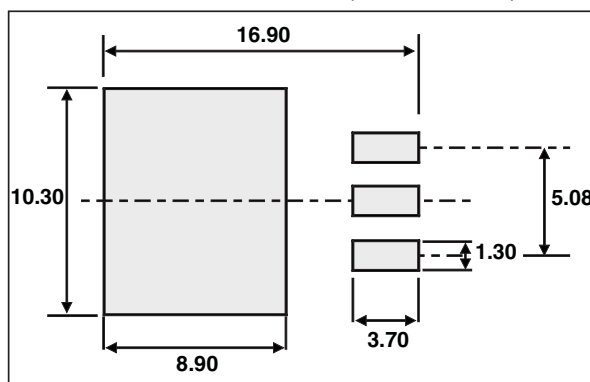

STTH2002C

PACKAGE MECHANICAL DATA
I²PAK

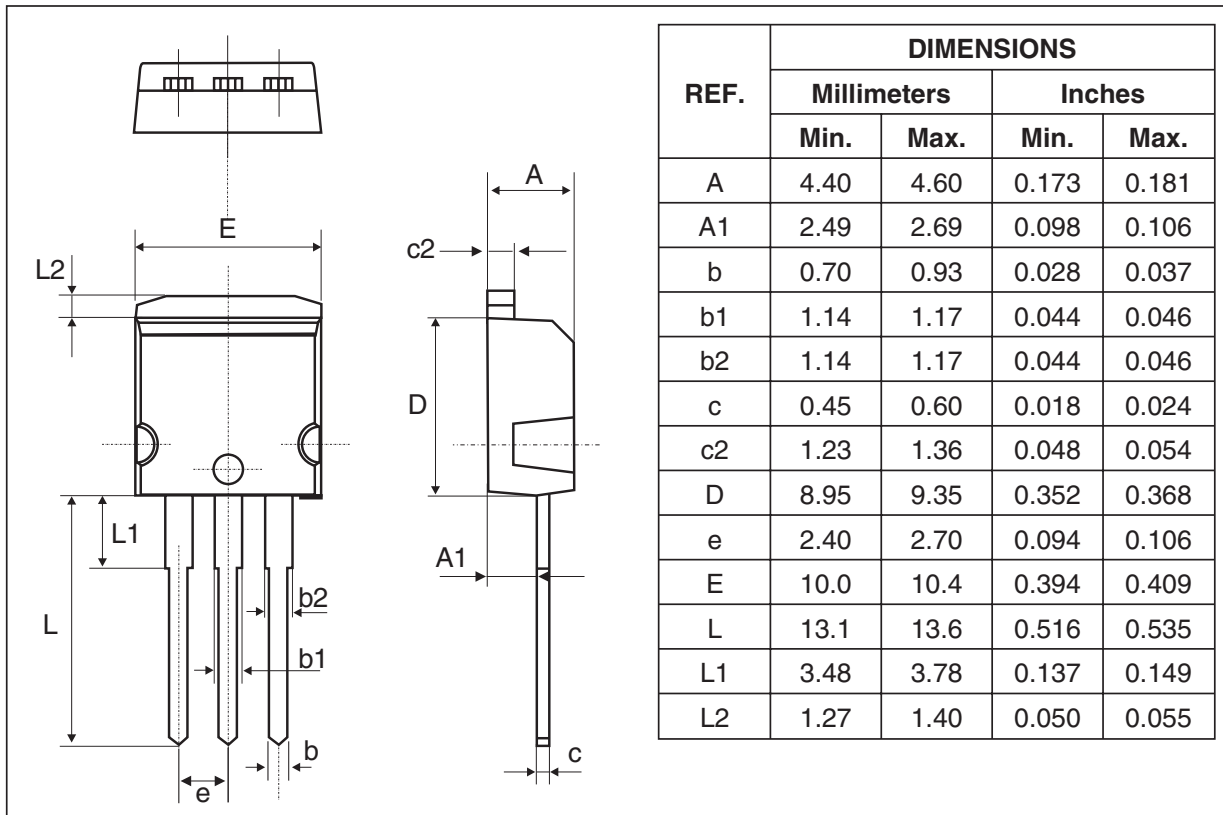

PACKAGE MECHANICAL DATA
TO-220FPAB

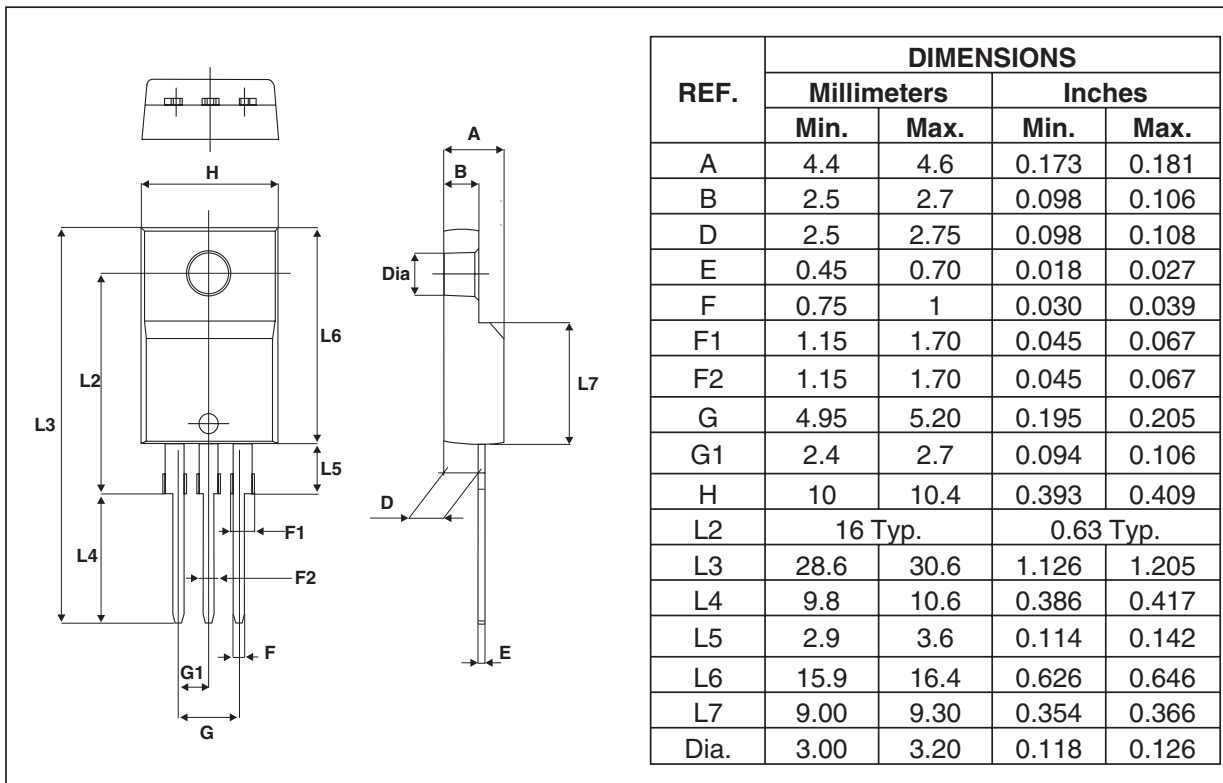

PACKAGE MECHANICAL DATA
TO-220AB

REF.	DIMENSIONS			
	Millimeters		Inches	
	Min.	Max.	Min.	Max.
A	4.40	4.60	0.173	0.181
C	1.23	1.32	0.048	0.051
D	2.40	2.72	0.094	0.107
E	0.49	0.70	0.019	0.027
F	0.61	0.88	0.024	0.034
F1	1.14	1.70	0.044	0.066
F2	1.14	1.70	0.044	0.066
G	4.95	5.15	0.194	0.202
G1	2.40	2.70	0.094	0.106
H2	10	10.40	0.393	0.409
L2	16.4 typ.		0.645 typ.	
L4	13	14	0.511	0.551
L5	2.65	2.95	0.104	0.116
L6	15.25	15.75	0.600	0.620
L7	6.20	6.60	0.244	0.259
L9	3.50	3.93	0.137	0.154
M	2.6 typ.		0.102 typ.	
Diam.	3.75	3.85	0.147	0.151

- Epoxy meets UL94,V0
- Cooling method: by conduction (method C)
- Recommended torque value (TO-220AB): 0.8 N.m.
- Maximum torque value (TO-220AB): 1.0 N.m.
- Recommended torque value (TO-220FPAB): 0.55 N.m.
- Maximum torque value (TO-220FPAB): 0.7 N.m.

Information furnished is believed to be accurate and reliable. However, STMicroelectronics assumes no responsibility for the consequences of use of such information nor for any infringement of patents or other rights of third parties which may result from its use. No license is granted by implication or otherwise under any patent or patent rights of STMicroelectronics. Specifications mentioned in this publication are subject to change without notice. This publication supersedes and replaces all information previously supplied. STMicroelectronics products are not authorized for use as critical components in life support devices or systems without express written approval of STMicroelectronics.

The ST logo is a registered trademark of STMicroelectronics.

All other names are the property of their respective owners.

© 2004 STMicroelectronics - All rights reserved.

STMicroelectronics GROUP OF COMPANIES

Australia - Belgium - Brazil - Canada - China - Czech Republic - Finland - France - Germany -
 Hong Kong - India - Israel - Italy - Japan - Malaysia - Malta - Morocco - Singapore - Spain -
 Sweden - Switzerland - United Kingdom - United States

www.st.com

