



### Features

- Wide Input Voltage Range: 38V to 75V
- 1,500 VDC Isolation
- 6 Pin DIP Package
- Low-Profile (8mm)
- Pin-compatible with PT4200 Series
- No External Components Required <sup>2</sup>
- Safety Approvals —Pending

### Description

The PT4210 series of low-power isolated DC-DC converters are pin-

compatible with Power Trends' popular PT4200 series. The PT4210 series has improved load regulation over the PT4200, and is a compatible alternative for both new and existing designs. Applications include Telecom and Datacom systems where both board space and height are a premium.

The PT4210 series is offered in both through-hole or SMD-DIP package types with single non-adjustable output voltages of 3.3V, 5V, and 12V.

### Ordering Information

- PT4212□ = 3.3V/1.5A  
 PT4213□ = 5V/1.2A  
 PT4214□ = 12V/0.6A

### Package Suffix (PT1234X)

Case/Pin Configuration	
Through-Hole	<b>A</b>
Surface Mount	<b>C</b>

(For dimensions and PC board layout, see Package Style 910)

### Pin-Out Information

Pin	Function
1	+V <sub>out</sub>
2	-V <sub>out</sub>
8	N/C
11	Remote On/Off *
17	-V <sub>in</sub>
18	+V <sub>in</sub>

### Package Top View

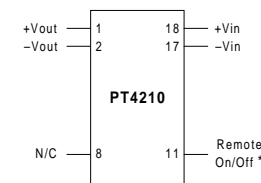

### Specifications

Characteristics (T <sub>a</sub> = 25°C unless noted)	Symbols	Conditions	PT4210 SERIES			Units	
			Min	Typ	Max		
Output Current	I <sub>o</sub>	Over V <sub>in</sub> range	PT4212 (3.3V) PT4213 (5.0V) PT4214 (12V)	0 0 0	— — —	1.5 1.2 0.6	A
Output Voltage Tolerance	ΔV <sub>o</sub>	Over V <sub>in</sub> range, 10% I <sub>o,max</sub> ≤ I <sub>o</sub> ≤ I <sub>o,max</sub> , -40°C < T <sub>a</sub> < 85°C	PT4212 PT4213 PT4214	3.17 4.85 11.5	— — —	3.5 5.25 12.5	V
Idling Voltage	V <sub>o</sub>	I <sub>o</sub> = 0A	PT4212 PT4213 PT4214	— — —	3.7 5.4 12.7	3.9 5.9 17	V
Line Regulation	Reg <sub>line</sub>	Over V <sub>in</sub> range @ max I <sub>o</sub>	PT4212/4213 PT4214	— —	±20 ±45	— —	mV
Load Regulation	Reg <sub>load</sub>	V <sub>in</sub> = 53V 10% I <sub>o,max</sub> ≤ I <sub>o</sub> ≤ I <sub>o,max</sub>	PT4212/13 PT4214	— —	±100 ±150	— —	mV
Current Limit	I <sub>lim</sub>	Over V <sub>in</sub> range	PT4212 PT4213 PT4214	— — —	3.0 3.0 1.5	— — —	A
Short Circuit Current	I <sub>sc</sub>	Over V <sub>in</sub> range	PT4212 PT4213 PT4214	— — —	2.4 1.5 1.0	— — —	A
Inrush Current	I <sub>ir</sub> t <sub>ir</sub>	V <sub>in</sub> = 53V @ max I <sub>o</sub> On start-up		— —	0.5 1.0	— —	A mSec
Input Voltage Range	V <sub>in</sub>	Over I <sub>o</sub> range		38	—	75	V
V <sub>o</sub> Ripple/Noise	V <sub>n</sub>	V <sub>in</sub> = 53V, I <sub>o</sub> = I <sub>o,max</sub>		—	30	70	mV <sub>pp</sub>
Transient Response	t <sub>tr</sub>	V <sub>in</sub> = 53V, 10%..100% I <sub>o,max</sub> , 50% load step V <sub>o</sub> over/undershoot:	PT4212/4213 PT4214	— —	200 +150/-250 +250/-500	— — —	μSec mV
Efficiency	η	V <sub>in</sub> = 53V, I <sub>o</sub> = 1.5A, V <sub>in</sub> = 53V, I <sub>o</sub> = 1.2A, V <sub>in</sub> = 53V, I <sub>o</sub> = 0.6A,	PT4212 PT4213 PT4214	— — —	80 82 84	— — —	%
Switching Frequency	f <sub>o</sub>	Over V <sub>in</sub> and I <sub>o</sub> ranges		400	—	500	kHz
Operating Temperature	T <sub>a</sub>	Over V <sub>in</sub> range		-40	—	+85 (1)	°C
Storage Temperature	T <sub>s</sub>	—		-40	—	+125	°C
Mechanical Shock	—	Per Mil-STD-202F, Method 213B, 6mS half-sine, mounted to a PCB		—	TBD	—	G's
Mechanical Vibration	—	Per Mil-STD-202F, Method 204D, 10-500Hz, mounted to a PCB		—	TBD	—	G's
Weight	—	—		—	10	—	grams
Isolation	—	—		1500	—	—	VDC
Flammability	—	Materials meet UL 94V-0		—	—	—	—

**Notes:** (1) See SOA curves or consult the factory for the appropriate derating.

(2) The maximum output capacitance must not exceed 150μF for the PT4212, 120μF for the PT4213, and 47μF for the PT4214.

5-7 Watt Low-Profile Isolated DC-DC Converter

PT4212 Performance (See Note A)

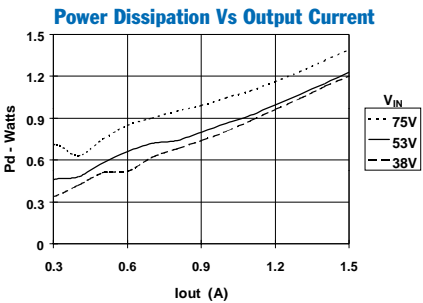
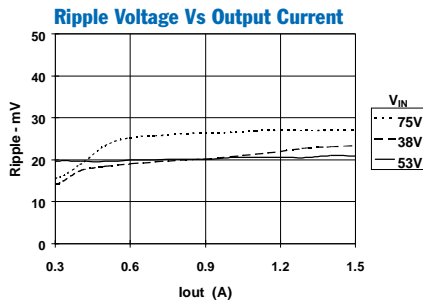
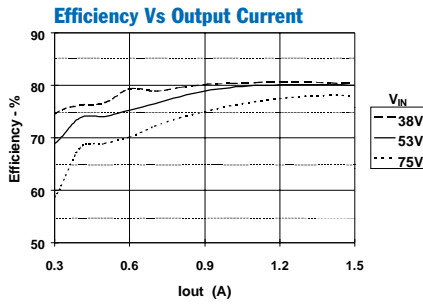

Safe Operating Area,  $V_{in} = 36-60V$

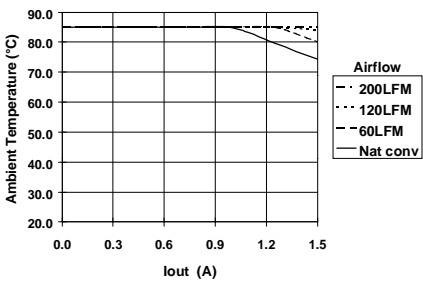

PT4213 Performance (See Note A)

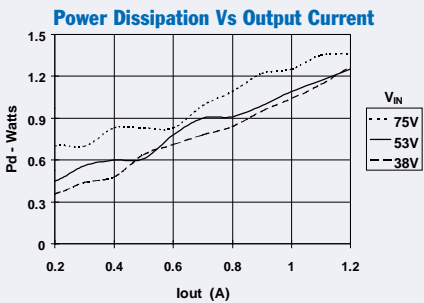
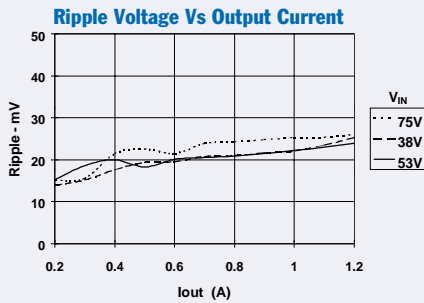
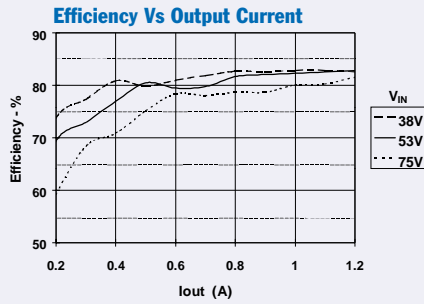

Safe Operating Area,  $V_{in} = 36-60V$

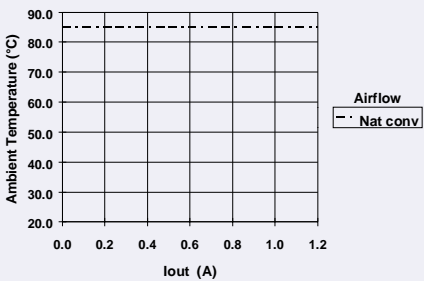

PT4214 Performance (See Note A)

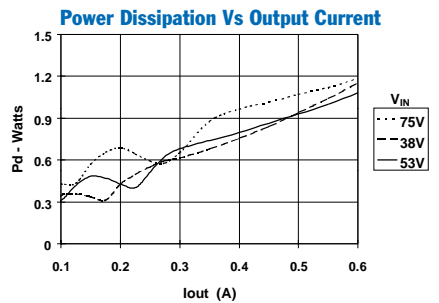
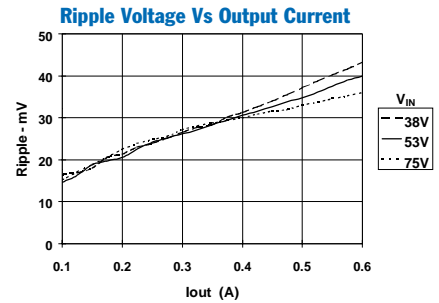
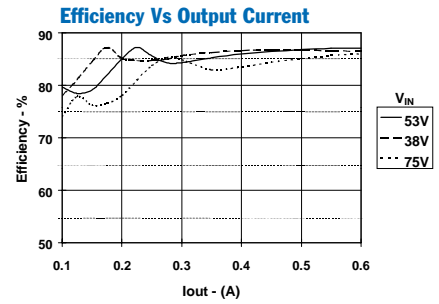

Safe Operating Area,  $V_{in} = 36-60V$

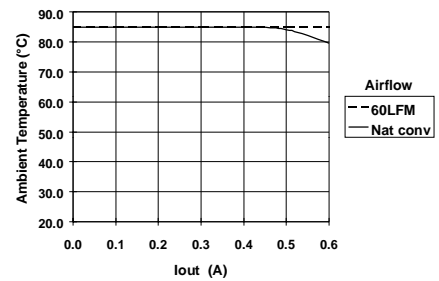

Note A: All Characteristic data in the above graphs has been developed from actual products tested at 25°C. This data is considered typical data for the converter.  
 Note B: SOA curves represent operating conditions at which internal components are at or below manufacturer's maximum rated operating temperatures.

### Using the Remote On/Off Function on the PT4210 Isolated 7W DC/DC Converters

Applications requiring output voltage On/Off control, the PT4210 DC/DC converter series incorporates a “Remote On/Off” control (pin 11). This feature can be used when there is a requirement for the module to be switched off without removing the applied input source voltage.

The converter functions normally with Pin 11 open-circuit, providing a regulated output voltage when a valid source voltage is applied to +V<sub>in</sub> (pin 18), with respect to -V<sub>in</sub> (pin 17). When a low-level<sup>1</sup> ground signal is applied to pin 11, the converter output will be turned off.

Figure 1 shows an application schematic, which details the typical use of the Remote On/Off function. Note the discrete transistor (Q1). The control pin has its own internal pull-up, and must be controlled with an open-collector or open-drain device (See notes 2 & 3). Table 1 gives the input requirements.

When placed in the “Off” state, the standby current drawn from the input source is typically reduced to less than 1mA.

**Table 1; Remote On/Off Control Requirements<sup>1</sup>**

Parameter	Min	Typ	Max
Disable	-0.1V	—	1.0V
Enable	5.0V <sup>3</sup>	—	Open-Circuit <sup>2</sup>
V <sub>O/c</sub> [Open-Circuit]	—	—	10V
I <sub>in</sub> [pin 11 at -V <sub>in</sub> ]	—	-100µA	—

#### Notes:

1. The Remote On/Off control uses -V<sub>in</sub> (pin 17) as its ground reference. All voltages specified are with respect to -V<sub>in</sub>.
2. Use an open-collector device (preferably a discrete transistor) for the Remote On/Off input. Do not connect a pull-up resistor directly to pin 11.
3. The Remote On/Off pin may be controlled with devices that have a totem-pole output providing that a blocking diode is used (See Figure 1). The blocking diode is required to prevent current from being injected into On/Off control pin. *Note: For TTL devices a pull-up may be required on the cathode side of the blocking diode. This is to guarantee a minimum enable voltage at pin 11 (See Figure 1).*
4. The PT4210 converters incorporate an “Under-Voltage Lockout” (UVLO). The UVLO will keep the module off when the input voltage to the converter is low, regardless of the state of the Remote On/Off control. Table 2 gives the UVLO input voltage thresholds.

**Table 2; UVLO Thresholds<sup>4</sup>**

Series	V <sub>in</sub> Range	UVLO Threshold
PT4210	38 – 75V	36V ±2V

**Figure 1**

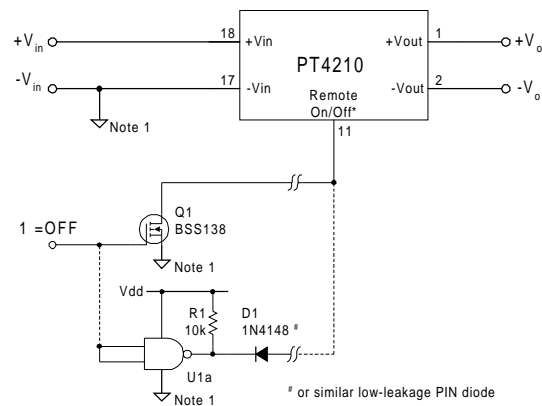

**Turn-On Time:** In the circuit of Figure 1, turning Q<sub>1</sub> on applies a low-voltage to pin 11 and disables the converter output. Correspondingly, turning Q<sub>1</sub> off allows pin 11 to be pulled high by an internal pull-up resistor. The converter produces a regulated output voltage within 50ms. Although the rise-time of the output is short (<1ms), the delay time will vary depending upon the input voltage and the module’s internal timing. Figure 2 shows an example of the output response for a PT4213 (5.0V), following the turn-off of Q<sub>1</sub> at time t=0. The waveform was measured with a 48Vdc input voltage, and 1.2A dc resistive load.

**Figure 2**

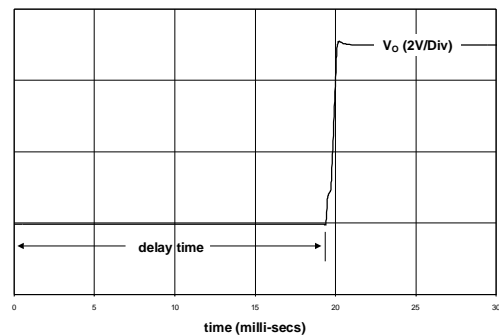

## PACKAGE INFORMATION AND DIMENSIONS

### Horizontal Through-Hole Mount (Suffix A)

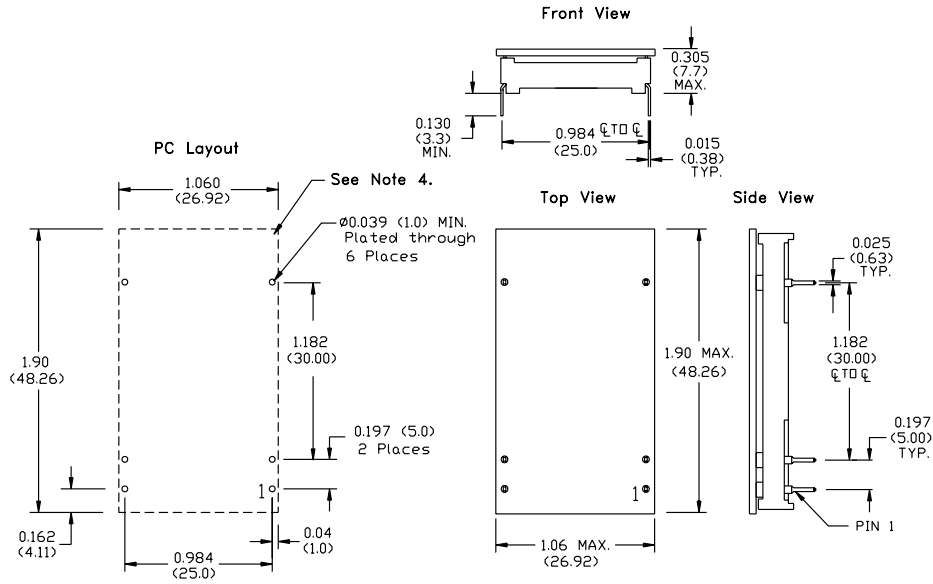

### Surface Mount (Suffix C)

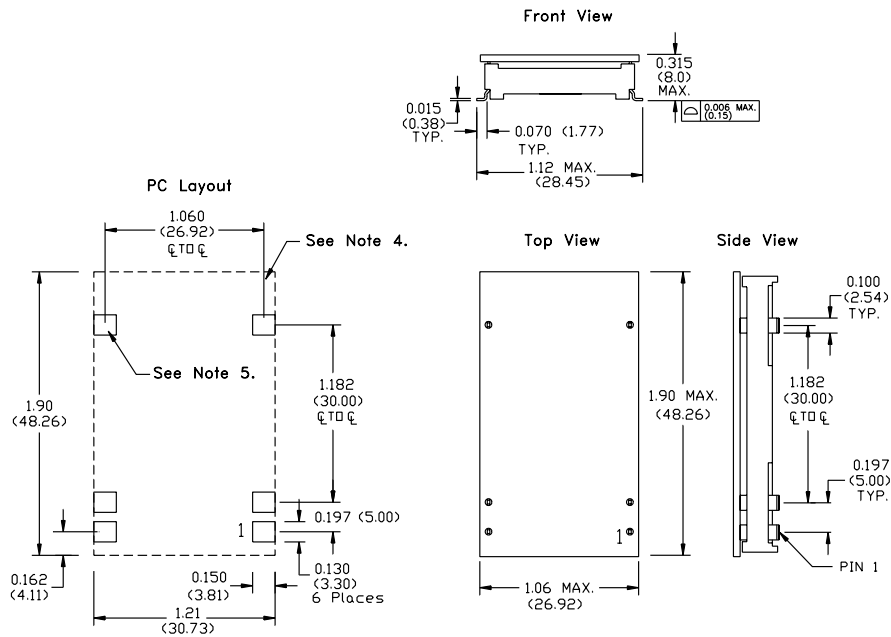

- Notes: (Rev.A)
- 1: All dimensions are in inches (mm).
  - 2: 2 place decimals are  $\pm 0.30$  ( $\pm 0.8$ mm).
  - 3: 3 place decimals are  $\pm 0.10$  ( $\pm 0.3$ mm).
  - 4: Recommended mechanical keep out area.
  - 5: Power pin connections should utilize two or more vias per input, ground and output pin.

## IMPORTANT NOTICE

Texas Instruments and its subsidiaries (TI) reserve the right to make changes to their products or to discontinue any product or service without notice, and advise customers to obtain the latest version of relevant information to verify, before placing orders, that information being relied on is current and complete. All products are sold subject to the terms and conditions of sale supplied at the time of order acknowledgment, including those pertaining to warranty, patent infringement, and limitation of liability.

TI warrants performance of its products to the specifications applicable at the time of sale in accordance with TI's standard warranty. Testing and other quality control techniques are utilized to the extent TI deems necessary to support this warranty. Specific testing of all parameters of each device is not necessarily performed, except those mandated by government requirements.

Customers are responsible for their applications using TI components.

In order to minimize risks associated with the customer's applications, adequate design and operating safeguards must be provided by the customer to minimize inherent or procedural hazards.

TI assumes no liability for applications assistance or customer product design. TI does not warrant or represent that any license, either express or implied, is granted under any patent right, copyright, mask work right, or other intellectual property right of TI covering or relating to any combination, machine, or process in which such products or services might be or are used. TI's publication of information regarding any third party's products or services does not constitute TI's approval, license, warranty or endorsement thereof.

Reproduction of information in TI data books or data sheets is permissible only if reproduction is without alteration and is accompanied by all associated warranties, conditions, limitations and notices. Representation or reproduction of this information with alteration voids all warranties provided for an associated TI product or service, is an unfair and deceptive business practice, and TI is not responsible nor liable for any such use.

Resale of TI's products or services with statements different from or beyond the parameters stated by TI for that product or service voids all express and any implied warranties for the associated TI product or service, is an unfair and deceptive business practice, and TI is not responsible nor liable for any such use.

Also see: [Standard Terms and Conditions of Sale for Semiconductor Products](http://www.ti.com/sc/docs/stdterms.htm). [www.ti.com/sc/docs/stdterms.htm](http://www.ti.com/sc/docs/stdterms.htm)

### Mailing Address:

Texas Instruments  
Post Office Box 655303  
Dallas, Texas 75265