

LOW DROPOUT VOLTAGE REGULATOR

FEATURES

- High Voltage Precision at $\pm 2.0\%$ or ± 60 mV
- Very Low Quiescent Current
- Very Low Dropout Voltage
- Reverse Bias Protection
- Miniature Package (SOT-23-3)
- Short Circuit Protection
- High Ripple Rejection

APPLICATIONS

- Battery Powered Systems
- Cellular Telephones
- Pagers
- Personal Communications Equipment
- Portable Instrumentation
- Portable Consumer Equipment
- Radio Control Systems
- Toys
- Low Voltage Systems

DESCRIPTION

The TK715xx is a low dropout linear regulator housed in a small SOT-23-3 package, rated at 350 mW. An internal PNP transistor is used to achieve a low dropout voltage of 105 mV (typ.) at 50 mA load current. This device offers high precision output voltage of $\pm 2.0\%$ or ± 60 mV. The TK715xx has a very low quiescent current of 25 μ A (typ.) at no load. The low quiescent current and dropout voltage make this part ideal for battery powered applications. The internal reverse bias protection eliminates the requirement for a reverse voltage protection diode, saving cost and board space. The high 64 dB ripple rejection and low noise provide enhanced performance for critical applications.

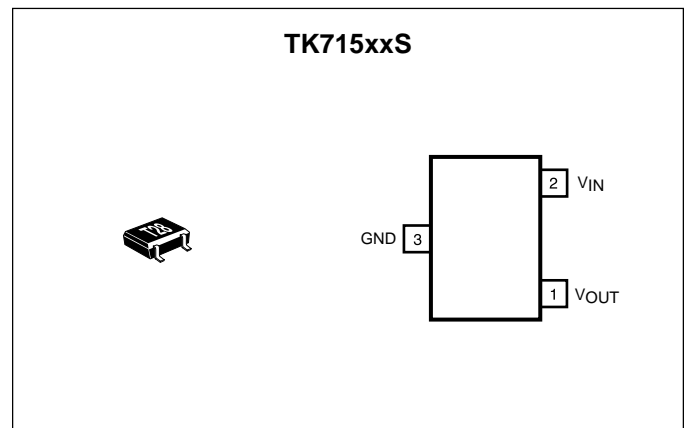

ORDERING INFORMATION

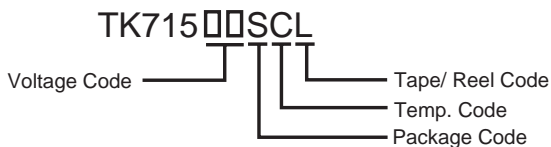

VOLTAGE CODE		TEMPERATURE CODE	TAPE/REEL CODE
19 = 1.9 V	37 = 3.7 V	C -30 to +80 °C	L: Tape Left
20 = 2.0 V	38 = 3.8 V		
21 = 2.1 V	39 = 3.9 V		
22 = 2.2 V	40 = 4.0 V		
23 = 2.3 V	41 = 4.1 V		
24 = 2.4 V	42 = 4.2 V		
25 = 2.5 V	43 = 4.3 V		
26 = 2.6 V	44 = 4.4 V		
27 = 2.7 V	45 = 4.5 V		
28 = 2.8 V	46 = 4.6 V		
29 = 2.9 V	47 = 4.7 V		
30 = 3.0 V	48 = 4.8 V		
31 = 3.1 V	49 = 4.9 V		
32 = 3.2 V	50 = 5.0 V		
33 = 3.3 V	60 = 6.0 V		
34 = 3.4 V	70 = 7.0 V		
35 = 3.5 V	80 = 8.0 V		
36 = 3.6 V	90 = 9.0 V		

PACKAGE CODE
S : SOT-23-3

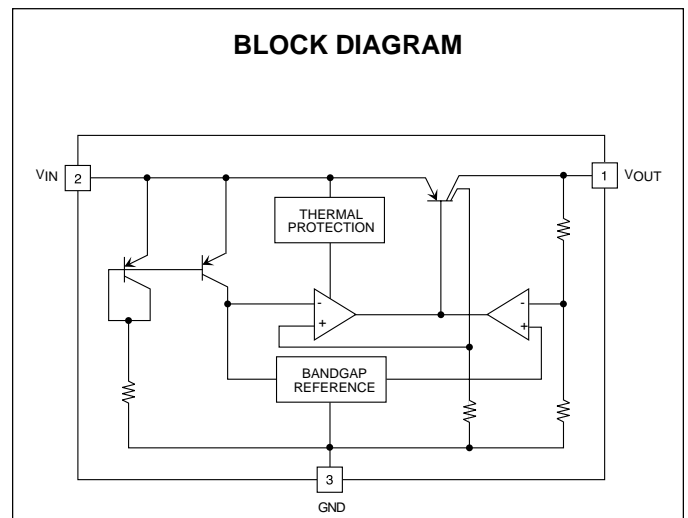

TK715xx

ABSOLUTE MAXIMUM RATINGS ($V_{OUT} \geq 5.0\text{ V}$)

Supply Voltage	-0.4 to 16 V	Max. Operating Temperature (Junction)	125 °C
Power Dissipation (Note 1)	350 mW	Operating Voltage Range	1.8 to 14.0 V
Reverse Bias	8 V	Junction Temperature	150 °C
Storage Temperature (Ambient)	-55 to +150 °C	Lead Soldering Temperature (10 s)	235 °C
Operating Temperature (Ambient)	-30 to +80 °C		

TK715xx ELECTRICAL CHARACTERISTICS ($V_{OUT} \geq 5.0\text{ V}$)

Test conditions: $T_A = 25\text{ °C}$, unless otherwise specified.

SYMBOL	PARAMETER	TEST CONDITIONS	MIN	TYP	MAX	UNITS
I_Q	Quiescent Current	$I_{OUT} = 0\text{ mA}$, $V_{OUT} \leq 4.0\text{ V}$		25	45	μA
		$I_{OUT} = 0\text{ mA}$, $V_{OUT} \geq 4.1\text{ V}$		30	50	μA
I_{GND}	Ground Current	$I_{OUT} = 50\text{ mA}$		1.4	2.5	mA
V_{OUT}	Output Voltage	$I_{OUT} = 10\text{ mA}$	See Table 1			V
Line Reg	Line Regulation	$V_{IN} = V_{OUT(TYP)} + 1\text{ V}$ to $V_{OUT(TYP)} + 6\text{ V}$		1.0	10	mV
Load Reg	Load Regulation	$I_{OUT} = 5\text{ to }50\text{ mA}$, (Note 2)		10	30	mV
		$I_{OUT} = 5\text{ to }100\text{ mA}$, (Note 2)		20	50	mV
V_{DROP}	Dropout Voltage	$I_{OUT} = 50\text{ mA}$		0.105	.0180	V
		$I_{OUT} = 100\text{ mA}$, $V_{OUT} \geq 2.4\text{ V}$		0.185	0.280	V
		$I_{OUT} = 100\text{ mA}$, $V_{OUT} < 2.4\text{ V}$		0.185	0.330	V
I_{OUT}	Continuous Output Current				100	mA
RR	Ripple Rejection	(Notes 3,4)		64		dB
$\Delta V_{OUT} / \Delta T$	Temperature Coefficient	$I_{OUT} = 10\text{ mA}$		35		ppm/°C

Note 1: Power dissipation is 350 mW when mounted as recommended. Derate at 2.8 mW/°C for operation above 25 °C.

Note 2: Refer to "Definition of Terms."

Note 3: Ripple rejection and noise voltage are affected by the value and characteristics of the capacitor used.

Note 4: Ripple rejection is measured at $V_R = 200\text{ mVrms}$, $V_{IN} = V_{OUT(TYP)} + 2\text{ V}$, $I_{OUT} = 10\text{ mA}$, $C_L = 4.7\text{ }\mu\text{F}$, $f = 100\text{ Hz}$.

Gen. Note: Parameters with min. or max. values are 100% tested at $T_A = 25\text{ °C}$.

ABSOLUTE MAXIMUM RATINGS ($V_{OUT} \leq 6.0$ V)

Supply Voltage	-0.4 to 16 V	Max. Operating Temperature (Junction)	125 °C
Power Dissipation (Note 1)	350 mW	Operating Voltage Range	2.5 to 14.0 V
Reverse Bias	8 V	Junction Temperature	150 °C
Storage Temperature (Ambient)	-55 to +150 °C	Lead Soldering Temperature (10 s)	235 °C
Operating Temperature (Ambient)	-30 to +80 °C		

TK715xx ELECTRICAL CHARACTERISTICS ($V_{OUT} \leq 6.0$ V)

Test conditions: $T_A = 25$ °C, unless otherwise specified.

SYMBOL	PARAMETER	TEST CONDITIONS	MIN	TYP	MAX	UNITS
I_Q	Quiescent Current	$I_{OUT} = 0$ mA		32	60	μ A
I_{GND}	Ground Current	$I_{OUT} = 50$ mA		1.4	2.5	mA
V_{OUT}	Output Voltage	$I_{OUT} = 10$ mA	See Table 1			V
Line Reg	Line Regulation	$V_{IN} = V_{OUT(TYP)} + 1$ V to $V_{OUT(TYP)} + 6$ V or Max 14 V		3.0		mV
Load Reg	Load Regulation	$I_{OUT} = 5$ to 50 mA, (Note 2)		10	30	mV
		$I_{OUT} = 5$ to 100 mA, (Note 2)		20	50	mV
V_{DROP}	Dropout Voltage	$I_{OUT} = 50$ mA		0.105	.0180	V
		$I_{OUT} = 100$ mA		0.185	0.280	V
I_{OUT}	Continuous Output Current				100	mA
RR	Ripple Rejection	(Notes 3,4)		64		dB
$\Delta V_{OUT} / \Delta T$	Temperature Coefficient	$I_{OUT} = 10$ mA		35		ppm/° C

Note 1: Power dissipation is 350 mW when mounted as recommended. Derate at 2.8 mW/°C for operation above 25 °C.

Note 2: Refer to "Definition of Terms."

Note 3: Ripple rejection and noise voltage are affected by the value and characteristics of the capacitor used.

Note 4: Ripple rejection is measured at $V_R = 200$ mVrms, $V_{IN} = V_{OUT(TYP)} + 2$ V, $I_{OUT} = 10$ mA, $C_L = 4.7$ μ F, $f = 100$ Hz.

Gen. Note: Parameters with min. or max. values are 100% tested at $T_A = 25$ °C.

TK715xx

TK715xx ELECTRICAL CHARACTERISTICS TABLE 1

Output Voltage	Voltage Code	V _{OUT(MIN)}	V _{OUT(MAX)}	Test Voltage
1.9 V	19	1.840 V	1.960 V	2.9 V
2.0 V	20	1.940 V	2.060 V	3.0 V
2.1 V	21	2.040 V	2.160 V	3.1 V
2.2 V	22	2.140 V	2.260 V	3.2 V
2.3 V	23	2.240 V	2.360 V	3.3 V
2.4 V	24	2.340 V	2.460 V	3.4 V
2.5 V	25	2.440 V	2.560 V	3.5 V
2.6 V	26	2.540 V	2.660 V	3.6 V
2.7 V	27	2.640 V	2.760 V	3.7 V
2.8 V	28	2.740 V	2.860 V	3.8 V
2.9 V	29	2.840 V	2.960 V	3.9 V
3.0 V	30	2.940 V	3.060 V	4.0 V
3.1 V	31	3.040 V	3.160 V	4.1 V
3.2 V	32	3.140 V	3.260 V	4.2 V
3.3 V	33	3.240 V	3.360 V	4.3 V
3.4 V	34	3.335 V	3.465 V	4.4 V
3.5 V	35	3.435 V	3.565 V	4.5 V
3.6 V	36	3.535 V	3.665 V	4.6 V

Output Voltage	Voltage Code	V _{OUT(MIN)}	V _{OUT(MAX)}	Test Voltage
3.7 V	37	3.630 V	3.770 V	4.7 V
3.8 V	38	3.725 V	3.875 V	4.8 V
3.9 V	39	3.825 V	3.975 V	4.9 V
4.0 V	40	3.920 V	4.080 V	5.0 V
4.1 V	41	4.020 V	4.180 V	5.1 V
4.2 V	42	4.120 V	4.280 V	5.2 V
4.3 V	43	4.215 V	4.385 V	5.3 V
4.4 V	44	4.315 V	4.485 V	5.4 V
4.5 V	45	4.410 V	4.590 V	5.5 V
4.6 V	46	4.510 V	4.690 V	5.6 V
4.7 V	47	4.605 V	4.795 V	5.7 V
4.8 V	48	4.705 V	4.895 V	5.8 V
4.9 V	49	4.800 V	5.000 V	5.9 V
5.0 V	50	4.900 V	5.100 V	6.0 V
6.0 V	60	5.880 V	6.120 V	7.0 V
7.0 V	70	6.860 V	7.140 V	8.0 V
8.0 V	80	7.840 V	8.160 V	9.0 V
9.0 V	90	8.820 V	9.180 V	9.0 V

TEST CIRCUIT

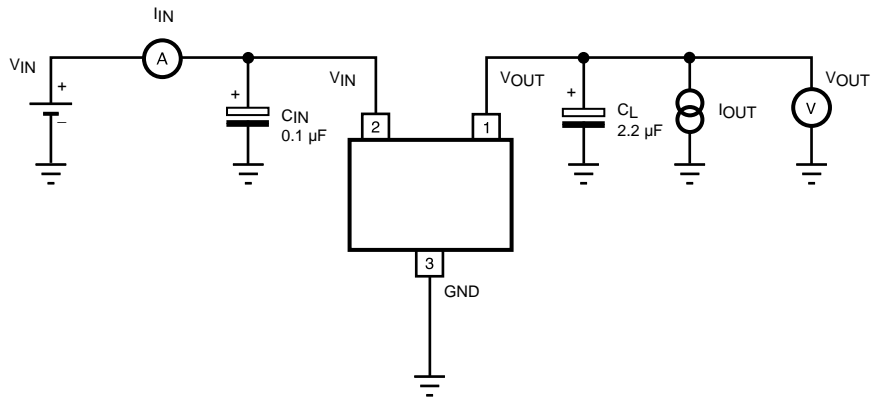

TYPICAL PERFORMANCE CHARACTERISTICS

$T_A = 25\text{ }^\circ\text{C}$, unless otherwise specified.

LOAD REGULATION

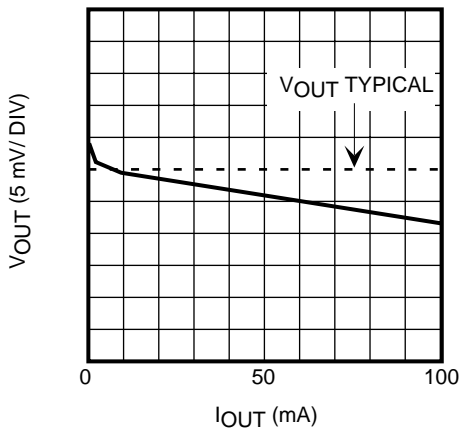

SHORT CIRCUIT PROTECTION

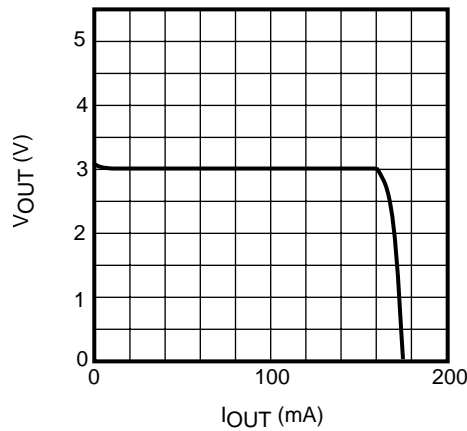

OUTPUT VOLTAGE vs. INPUT VOLTAGE

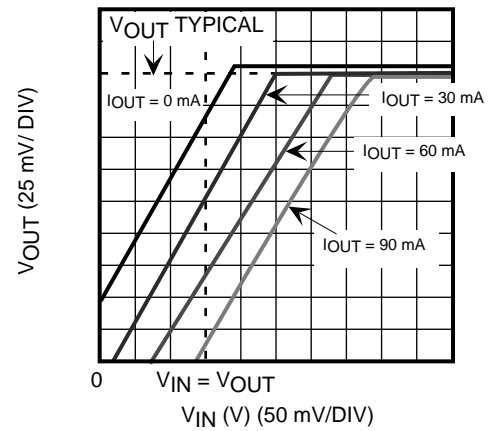

LINE REGULATION

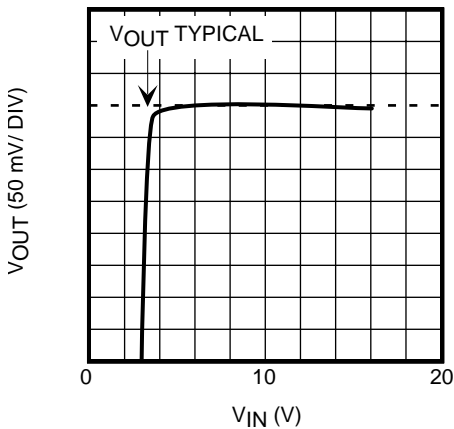

REVERSE BIAS CURRENT RANGE (V_IN = 0 V)

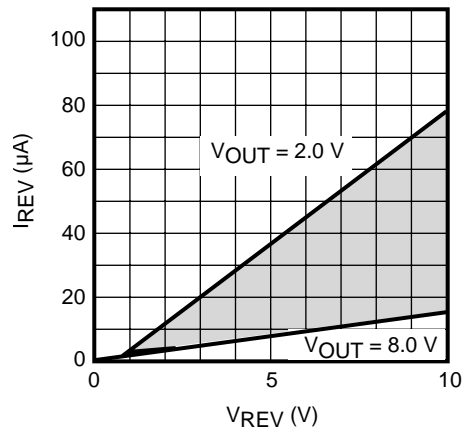

QUIESCENT CURRENT vs. INPUT VOLTAGE

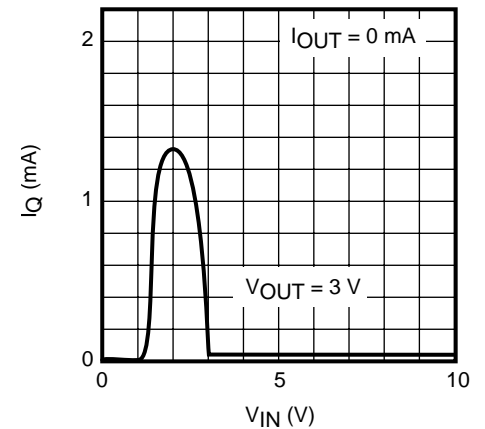

TYPICAL PERFORMANCE CHARACTERISTICS (CONT.)

$T_A = 25\text{ }^\circ\text{C}$, unless otherwise specified.

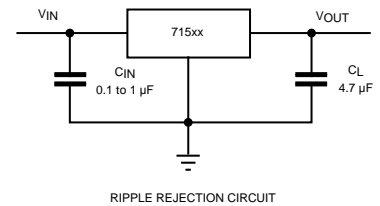
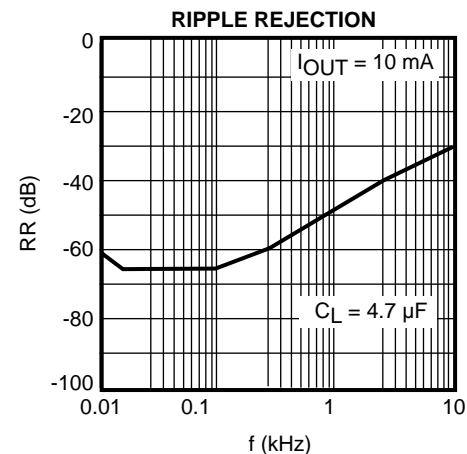
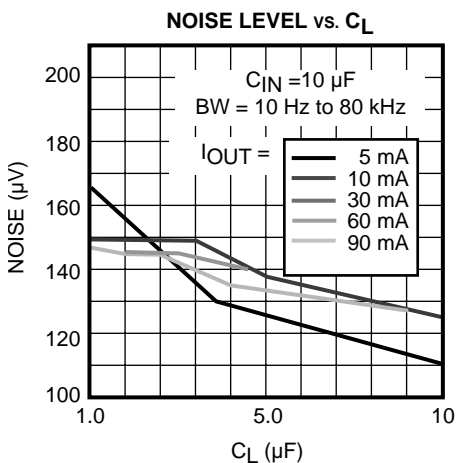
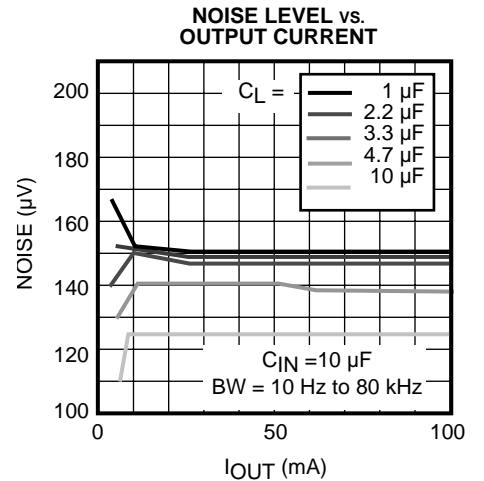
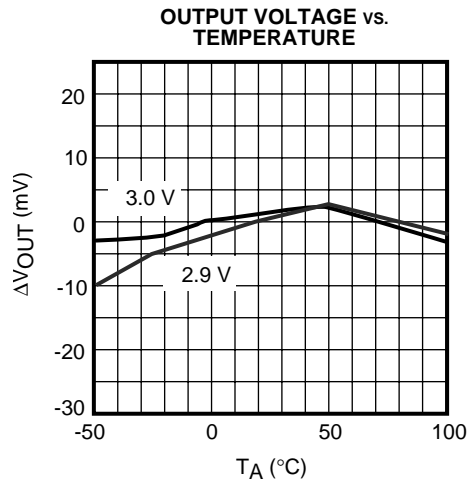
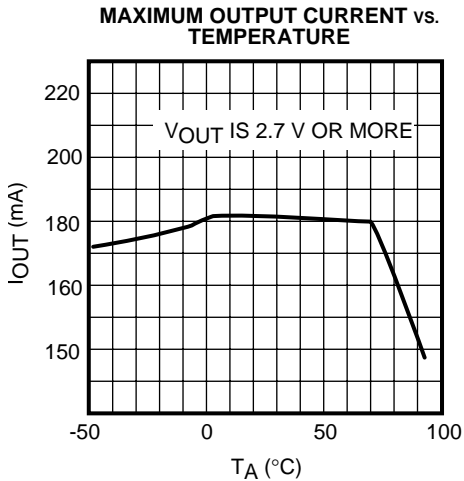
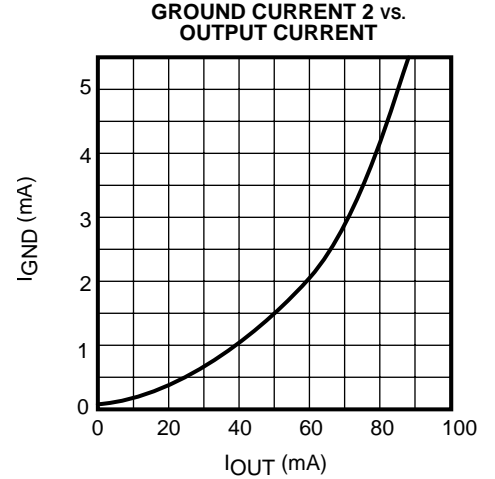
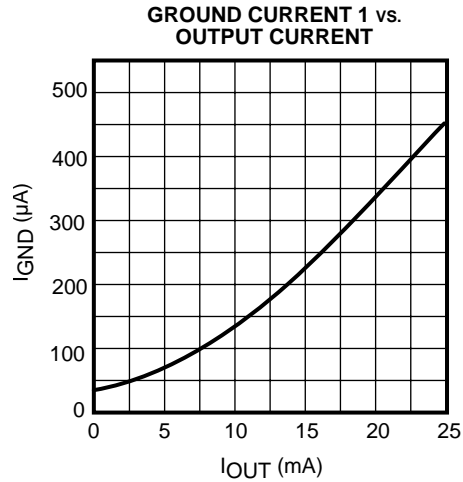
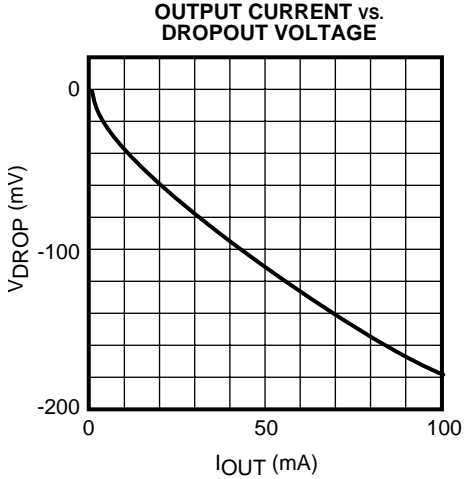

TYPICAL PERFORMANCE CHARACTERISTICS (CONT.)

$T_A = 25\text{ }^\circ\text{C}$, unless otherwise specified.

LOAD CURRENT STEP RESPONSE 2

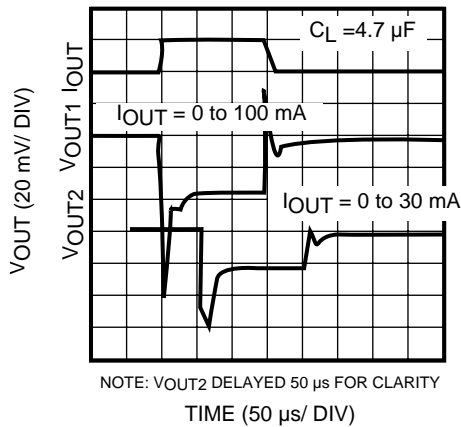

LINE VOLTAGE STEP RESPONSE

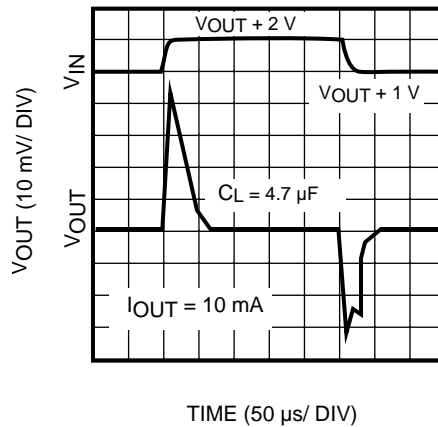

NOISE SPECTRUM

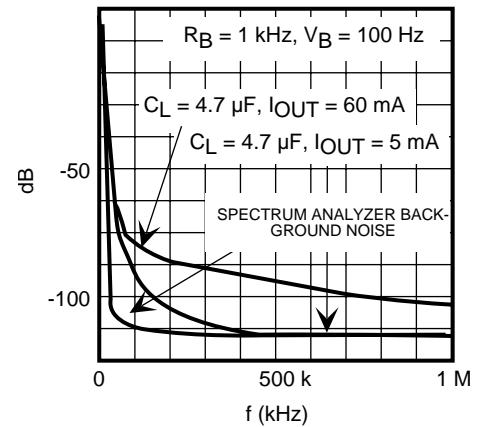

LOAD CURRENT STEP RESPONSE 1

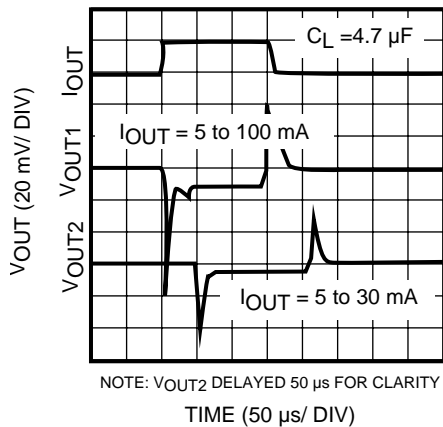

DEFINITION AND EXPLANATION OF TECHNICAL TERMS

OUTPUT VOLTAGE (V_{OUT})

The output voltage is specified with $V_{IN} = (V_{OUT(TYP)} + 1 \text{ V})$ and $I_{OUT} = 30 \text{ mA}$.

DROPOUT VOLTAGE (V_{DROP})

The dropout voltage is the difference between the input voltage and the output voltage at which point the regulator starts to fall out of regulation. Below this value, the output voltage will fall as the input voltage is reduced. It is dependent upon the load current and the junction temperature.

CONTINUOUS OUTPUT CURRENT (I_{OUT})

Normal operating output current. This is limited by package power dissipation.

PULSE OUTPUT CURRENT ($I_{OUT(PULSE)}$)

Maximum pulse width 5 ms at V_{OUT} above 2.0 V, duty cycle 12.5%: pulse load only.

LINE REGULATION (Line Reg)

Line regulation is the ability of the regulator to maintain a constant output voltage as the input voltage changes. The line regulation is specified as the input voltage is changed from $V_{IN} = V_{OUT(TYP)} + 1 \text{ V}$ to $V_{IN} = V_{OUT(TYP)} + 6 \text{ V}$ or $V_{IN} = \text{max } 14 \text{ V}$.

LOAD REGULATION (Load Reg)

Load regulation is the ability of the regulator to maintain a constant output voltage as the load current changes. It is a pulsed measurement to minimize temperature effects with the input voltage set to $V_{IN} = V_{OUT(TYP)} + 1 \text{ V}$. The load regulation is specified under two output current step conditions of 1 mA to 60 mA and 1 mA to 100 mA.

QUIESCENT CURRENT (I_Q)

The quiescent current is the current which flows through the ground terminal under no load conditions ($I_{OUT} = 0 \text{ mA}$).

GROUND CURRENT (I_{GND})

Ground current is the current which flows through the ground pin(s). It is defined as $I_{IN} - I_{OUT}$, excluding control

current.

RIPPLE REJECTION RATIO (RR)

Ripple rejection is the ability of the regulator to attenuate the ripple content of the input voltage at the output. It is specified with 200 mVrms, 100 Hz superimposed on the input voltage, where $V_{IN} = V_{OUT(TYP)} + 2.0 \text{ V}$. The output decoupling capacitor is set to 4.7 μF and the load current is set to 5 mA. Ripple rejection is the ratio of the ripple content of the output vs. the input and is expressed in dB.

REVERSE VOLTAGE PROTECTION

Reverse voltage protection prevents damage due to the output voltage being higher than the input voltage. This fault condition can occur when the output capacitor remains charged and the input is reduced to zero, or when an external voltage higher than the input voltage is applied to the output side.

REDUCTION OF OUTPUT NOISE

Although the architecture of the Toko regulators are designed to minimize semiconductor noise, further reduction can be achieved by the selection of external components. The obvious solution is to increase the size of the output capacitor. Please note that several parameters are affected by the value of the capacitors and bench testing is recommended when deviating from standard values.

PACKAGE POWER DISSIPATION (P_D)

This is the power dissipation level at which the thermal sensor is activated. The IC contains an internal thermal sensor which monitors the junction temperature. When the junction temperature exceeds the monitor threshold of 150 °C, the IC is shut down. The junction temperature rises as the difference between the input power ($V_{IN} \times I_{IN}$) and the output power ($V_{OUT} \times I_{OUT}$) increases. The rate of temperature rise is greatly affected by the mounting pad configuration on the PCB, the board material, and the ambient temperature. When the IC mounting has good thermal conductivity, the junction temperature will be low even if the power dissipation is great. When mounted on the recommended mounting pad, the power dissipation of the SOT-23-3 is increased to 350 mW. For operation at ambient temperatures over 25 °C, the power dissipation of the SOT-23-3 device should be derated at 2.8 mW/°C. To

DEFINITION AND EXPLANATION OF TECHNICAL TERMS (CONT.)

determine the power dissipation for shutdown when mounted, attach the device on the actual PCB and deliberately increase the output current (or raise the input voltage) until the thermal protection circuit is activated. Calculate the power dissipation of the device by subtracting the output power from the input power. These measurements should allow for the ambient temperature of the PCB. The value obtained from $P_D / (150^\circ\text{C} - T_A)$ is the derating factor. The PCB mounting pad should provide maximum thermal conductivity in order to maintain low device temperatures. As a general rule, the lower the temperature, the better the reliability of the device. The thermal resistance when mounted is expressed as follows:

$$T_j = \theta_{jA} \times P_D + T_A$$

For Toko ICs, the internal limit for junction temperature is 150 °C. If the ambient temperature (T_A) is 25 °C, then:

$$150^\circ\text{C} = \theta_{jA} \times P_D + 25^\circ\text{C}$$

$$\theta_{jA} = 125^\circ\text{C} / P_D$$

P_D is the value when the thermal sensor is activated. A simple way to determine P_D is to calculate $V_{IN} \times I_{IN}$ when the output side is shorted. Input current gradually falls as temperature rises. You should use the value when thermal equilibrium is reached.

The range of usable currents can also be found from the graph below.

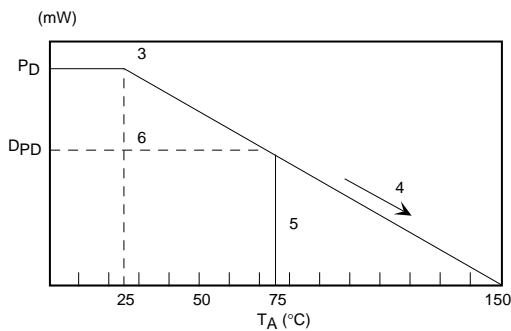

Procedure:

- 1) Find P_D
- 2) P_{D1} is taken to be $P_D \times (-0.8 - 0.9)$

- 3) Plot P_{D1} against 25 °C
- 4) Connect P_{D1} to the point corresponding to the 150 °C with a straight line.
- 5) In design, take a vertical line from the maximum operating temperature (e.g., 75 °C) to the derating curve.
- 6) Read off the value of P_D against the point at which the vertical line intersects the derating curve. This is taken as the maximum power dissipation, D_{PD} .

The maximum operating current is:

$$I_{OUT} = (D_{PD} / (V_{IN(MAX)} - V_{OUT}))$$

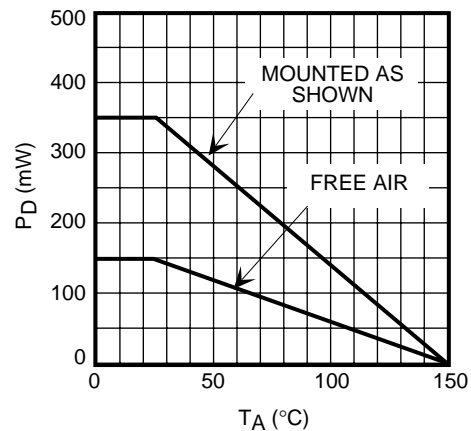

SOT-23-3 POWER DISSIPATION CURVE

APPLICATION INFORMATION

INPUT-OUTPUT CAPACITORS

Linear regulators require input and output capacitors in order to maintain regulator loop stability. The output capacitor should be selected within the Equivalent Series Resistance (ESR) range as shown in the graphs below for stable operation. When a ceramic capacitor is connected in parallel with the output capacitor, a maximum of 1000 pF is recommended. This is because the ceramic capacitor's electrical characteristics (capacitance and ESR) vary widely over temperature. If a large ceramic capacitor is used, a resistor should be connected in series with it to bring it into the stable operating area shown in the graphs below. Minimum resistance should be added to maintain load and line transient response.

Note: It is very important to check the selected manufacturers electrical characteristics (capacitance and ESR) over temperature.

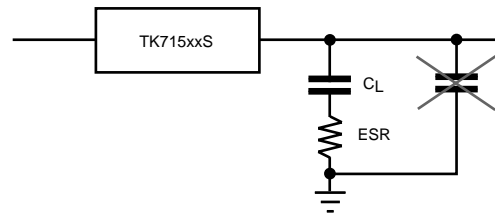
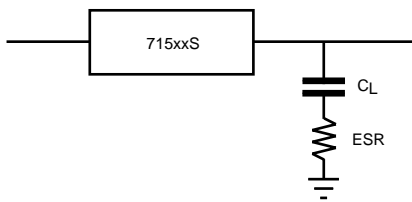

Note: It is not necessary to connect a ceramic capacitor in parallel with an aluminum or tantalum output capacitor.

$C_L = 1.0 \mu\text{F}$

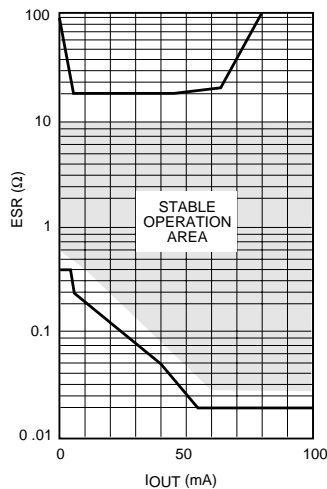

$C_L = 2.2 \mu\text{F}$

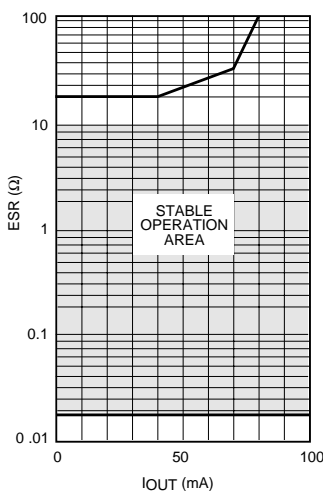

$C_L = 4.7 \mu\text{F}$

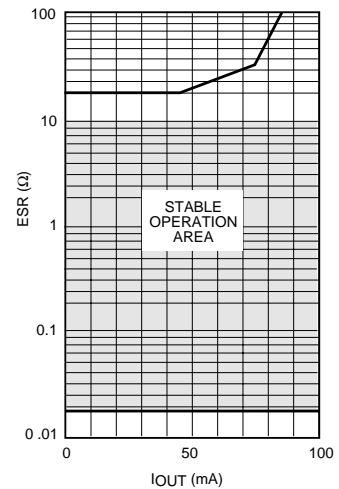

APPLICATION INFORMATION (CONT.)

In general, the capacitor should be at least 1 μF and be rated for the actual ambient operating temperature range. The table below shows typical characteristics for several types and values of capacitance. Please note that the ESR varies widely depending upon manufacturer, type, size, and material.

ESR Capacitance	Aluminum Capacitor	Tantalum Capacitor	Ceramic Capacitor
1.0 μF	2.4 Ω	2.3 Ω	0.140 Ω
2.2 μF	2.0 Ω	1.9 Ω	0.059 Ω
3.3 μF	4.6 Ω	1.0 Ω	0.049 Ω
10 μF	1.4 Ω	0.5 Ω	0.025 Ω

Note: ESR is measured at 10 kHz.

BOARD LAYOUT

Copper pattern should be as large as possible. Power dissipation is 350 mW for SOT-23-3. A low ESR capacitor is recommended. For low temperature operation, select a capacitor with a low ESR at the lowest operating temperature to prevent oscillation, degradation of ripple rejection and increase in noise. The minimum recommended capacitance is 2.2 μF .

The internal reverse bias protection eliminates the requirement for a reverse voltage protection diode. This saves both cost and board space.

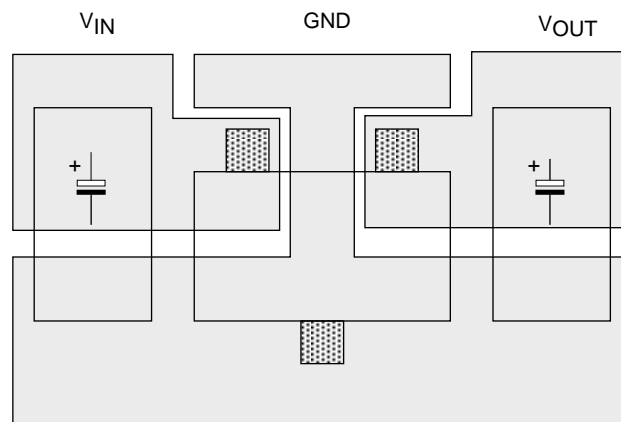

SOT-23-3 BOARD LAYOUT

APPLICATION INFORMATION (CONT.)

REVERSE BIAS PROTECTION

The internal reverse bias protection eliminates the requirement for a reverse voltage protection diode. This saves both cost and board space.

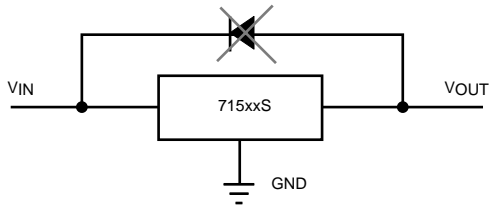

Another reverse bias protection technique is illustrated below. The extra diode and extra capacitor are not necessary with the TK715xx. The high output voltage accuracy is maintained because the diode forward voltage variations over temperature and load current have been eliminated.

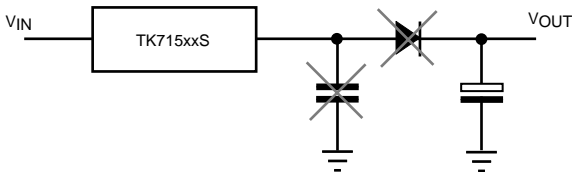

PARALLEL OPERATION

The series resistor R is put in the input line of the low output voltage regulator in order to prevent overdissipation. The voltage dropped across the resistor reduces the large input-to-output voltage across the regulator, reducing the power dissipation in the device.

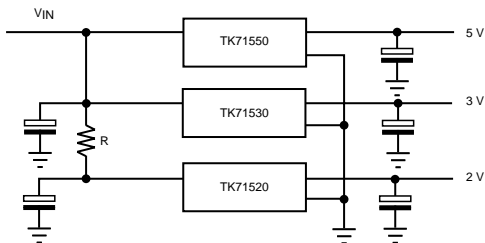

SWITCHING OPERATION

Even though the input voltages or the output voltages are different, the outputs of the TK715xx regulators can be connected together, and the output voltages switched. If two or more TK715xx regulators are turned ON simultaneously, the highest output voltage will be present.

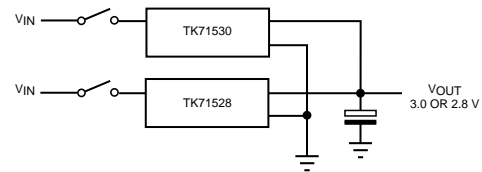

CURRENT BOOST OPERATION

The output current can be increased by connecting an external PNP transistor as shown below. The output current capability depends upon the H_{fe} of the external transistor. Note: The TK715xx internal short circuit protection and thermal sensor do not protect the external transistor.

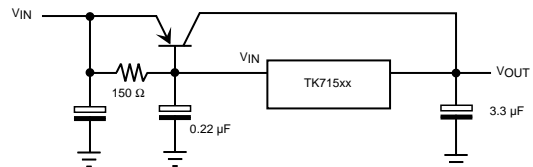

PACKAGE OUTLINE

SOT-23-3

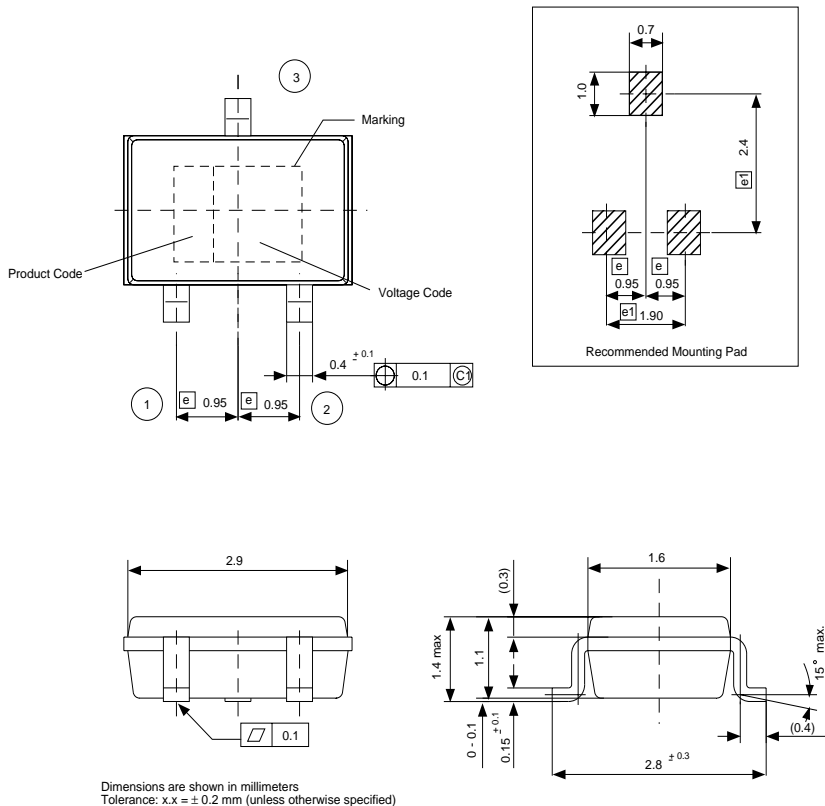

Marking Information

Product Code	T	Voltage Code
TK71519S	19	
TK71520S	20	
TK71521S	21	
TK71522S	22	
TK71523S	23	
TK71524S	24	
TK71525S	25	
TK71526S	26	
TK71527S	27	
TK71528S	28	
TK71529S	29	
TK71530S	30	
TK71531S	31	
TK71532S	32	
TK71533S	33	
TK71534S	34	
TK71535S	35	
TK71536S	36	
TK71537S	37	
TK71538S	38	
TK71539S	39	
TK71540S	40	
TK71541S	41	
TK71542S	42	
TK71543S	43	
TK71544S	44	
TK71545S	45	
TK71546S	46	
TK71547S	47	
TK71548S	48	
TK71549S	49	
TK71550S	50	
TK71560S	60	
TK71570S	70	
TK71580S	80	
TK71590S	90	



Toko America, Inc. Headquarters
 1250 Feehanville Drive, Mount Prospect, Illinois 60056
 Tel: (847) 297-0070 Fax: (847) 699-7864

TOKO AMERICA REGIONAL OFFICES

Midwest Regional Office
 Toko America, Inc.
 1250 Feehanville Drive
 Mount Prospect, IL 60056
 Tel: (847) 297-0070
 Fax: (847) 699-7864

Western Regional Office
 Toko America, Inc.
 2480 North First Street, Suite 260
 San Jose, CA 95131
 Tel: (408) 432-8281
 Fax: (408) 943-9790

Eastern Regional Office
 Toko America, Inc.
 107 Mill Plain Road
 Danbury, CT 06811
 Tel: (203) 748-6871
 Fax: (203) 797-1223

Semiconductor Technical Support
 Toko Design Center
 4755 Forge Road
 Colorado Springs, CO 80907
 Tel: (719) 528-2200
 Fax: (719) 528-2375

Visit our Internet site at <http://www.tokoam.com>

The information furnished by TOKO, Inc. is believed to be accurate and reliable. However, TOKO reserves the right to make changes or improvements in the design, specification or manufacture of its products without further notice. TOKO does not assume any liability arising from the application or use of any product or circuit described herein, nor for any infringements of patents or other rights of third parties which may result from the use of its products. No license is granted by implication or otherwise under any patent or patent rights of TOKO, Inc.