

**TOSHIBA**

# **LED Lamps**

**PRODUCT GUIDE**

## ■ Toshiba Visible LED Lamp Family Outline

### LED Lamp Family 299 products

InGaAlP

#### High-brightness lead type: 231 products

- TL\*H Series
- TL\*E Series
- TL\*U Series
- InGaAlP products are mainly from the World's highest luminosity level "TL\*H Series" to general-purpose "TL\*U Series"
- Stopper lead type and straight lead type available. (for ø5-mm type only)  
Suffix "P" indicates straight or stopper type.  
(example: TL\*E16TP is straight type.)



#### Surface-mount devices (SMDs): 68 products

- TL\*H Series
- TL\*E Series
- TL\*U Series
- S4F42\* Series
- S4F43\* Series
- Package size: 1.6 x 0.8 mm  
2.0 x 1.25 mm  
3.2 x 2.4 mm (ø2 lens-top)  
3.2 x 2.8 mm (flat type / ø3 lens-top)
- Four-element (InGaAlP) chip LEDs enable construction of low power dissipation equipment.
- Wider operating range: Topr = -40°C to 100°C  
(TL\*1100 Series, TL\*1102 Series, S4F42\* Series, S4F43\* Series)



#### Related catalog on website

The following related catalog are also published on the website.

"LED Lamps Application Guide"

<http://doc.semicon.toshiba.co.jp/noseek/us/buct/bcfm.htm>

# 1 New Product Digest

## 1. New TL\*H Series (Ultra-High-Brightness $\phi$ 5-mm LED Lamp Series)

Using thin-film crystal growth technology to produce the ultra-bright light-emitting material InGaAlP, as well as a new process and structure. Toshiba has developed a new line-up of InGaAlP ultra-bright LED lamps. These new LED lamps emit ultra-bright light. Higher brightness can be achieved at high temperature owing to an improved derating characteristic. The new series is effective in various applications such as outdoor LED information panels, high-brightness indications and backlighting for displays.

### Features

- A brightness approximately 1.3 times that of the existing high-brightness InGaAlP TL\*H Series of LED lamps can be achieved (comparison conditions:  $I_F = 20$  mA,  $T_a = 25^\circ\text{C}$ , same radiation pattern)
- Sufficient current can be obtained, even at high temperature, owing to an improved derating characteristic. Thus, at  $T_a = 50^\circ\text{C}$ , brightness is approximately double that of the existing TL\*H Series.
- High-brightness emission can be achieved even at low-current drive. Lowering the drive current reduces product power dissipation.
- Four types of  $\phi$ 5-mm lens with various radiation patterns are available.



### Uses

LED information panels, indicators  
The package specification in the product number for new TL\*H Series is now given as two digits instead of three as at present.

### Derating Characteristics

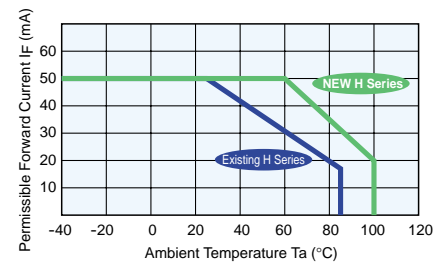

## 2. TLRME68TG Series (Round $\phi$ 3-mm InGaAlP LED Lamps Which Can Be Mounted Flush with PCB Using Surface Mounter)

When products are selected for use in equipment, mountability is a key factor. Most devices are now mounted using a high-speed surface mounter. To comply with this requirement, Toshiba has introduced a series of  $\phi$ 3-mm InGaAlP LED lamps which can be mounted flush with a PCB using a surface mounter. High-brightness InGaAlP, suitable for both indoor and outdoor applications, is used as the emitting substance. These new LED lamps can be used in a wide range of applications, such as LED information panels, low-power-consumption indicators and high-brightness backlighting for displays.

### Features

- Can be mounted flush with a PCB using a surface mounter. This enables reduction in assembly costs and time, reduction in height of finished product, and reduction of risk of damage due to finished products shifting during transportation.
- High-brightness InGaAlP LEDs used
- Transparent packages with wide viewing angle
- Emitted colors: red (626 nm and 613 nm), yellow and green
- Superior derating characteristics enable excellent high-brightness emission in high-temperature environments.
- Because high-brightness emission can be low, resulting in low power consumption by the equipment as a whole.



### Uses

Display light sources, information display boards, light sources for back-lighting

### Derating Characteristics

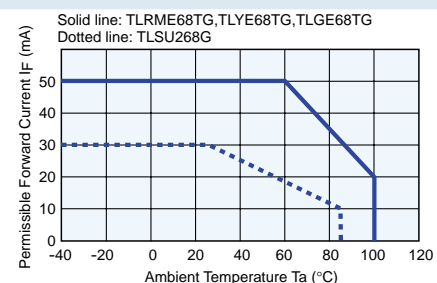

### 3. TLFGE / TLPYE Series with New Colors

Toshiba has added to its LED product line-up the TLFGE Series (of a color between those of the existing TLPGE and TLGE Series) and the TLPYE Series (of a color between those of the existing TLGE and TLYE Series). High-brightness InGaAlP, widely used in both indoor and outdoor applications, is used as the light-emitting material.

#### Features

- High-brightness InGaAlP LED
- Emitted colors: TLFGE Series (fresh green):  $\lambda_d = 565$  nm (typ.)  
TLPYE Series (pure yellow):  $\lambda_d = 580$  nm (typ.)
- High-brightness even at high temperature owing to improved derating characteristic
- High-brightness emission even at low-current drive. Product power dissipation can be reduced.
- Four types of  $\phi 5$ -mm and  $\phi 3$ -mm lens with various radiation patterns are available.  
Select a lens according to the intended application.



#### Uses

Display light sources, information display boards, light sources for backlighting

#### Derating Characteristics

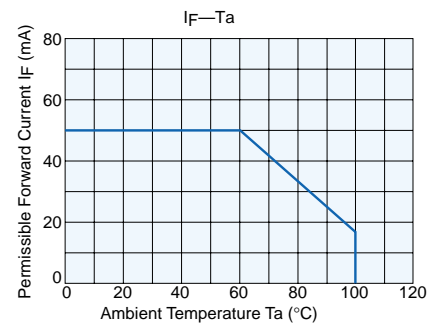

### 4. TLGU / TLPGU Series

Toshiba now offers a lead-type green U series. A brightness approximately five to eight times that of the Toshiba general-purpose medium-brightness Series (which uses GaP as the light-emitting material) can be achieved. High-brightness InGaAlP, widely used in both indoor and outdoor applications, is used as the light-emitting material.

#### Features

- High-brightness InGaAlP LED
- Emitted colors: TLGU Series (green):  $\lambda_d = 571$  nm  
TLPGU Series (pure green):  $\lambda_d = 558$  nm
- High-brightness even at high temperature owing to improved derating characteristic
- 20 types of green and pure-green  $\phi 5$ -mm and  $\phi 3$ -mm oval lens with various radiation patterns are available.  
Select a lens according to the intended application.



#### Uses

Display light sources, information display boards, panel indicators



# 2 Overview

## 1. Features

Toshiba LED lamps feature higher brightness, multiple colors and many types of package. Select LEDs for your applications as appropriate.

### Lead type

- Colors are from red to pure green (total 10 colors).
- Line-up of four-element (InGaAlP) compound semiconductors allows outdoor use.
- Many types of package enable the user to select LED lamps to suit his or her application.

### SMD type

- Miniature surface mount, upper-face emitting type
- A wide product line-up by high luminosity four-element (InGaAlP) emitted-light devices
- Can be used in automatic mounting.
- Suitable for reflow soldering
- Standard 1.6 x 0.8 mm type and 2 x 1.25 mm type  
The original  $\varnothing 2$ -mm lens-top type suitable for thin profile applications not possible with conventional lead type LEDs  
Select the best device for your own particular application.
- Line-up of high-heat resistance type  
Suitable for use in automobile backlight source

## 2. Uses

### Lead type

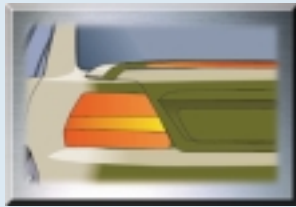

CHMSL  
(Center High Mounted Stop Lamp)



Light-emitting display



Traffic light



Message board



Security equipment

### SMD type



Thin-electronic bulletin board



OA equipment



Handy camera



Accessories on dashboard



FA equipment  
(Programmable control, etc.)



Home/cellular telephone



AV equipment  
(Karaoke set, etc.)

### 3. Merits of Four-Element High-Brightness LED Lamps

#### What are four-element LEDs?

These are composite semiconductor devices made up of four elements (In, Ga, Al and P). High-intensity emissions are possible from pure green to red, using the same materials and the same crystal growth method. Compared to other materials, these materials offer extremely high efficiency light emission in LEDs.

#### Wide market size for four-element LEDs

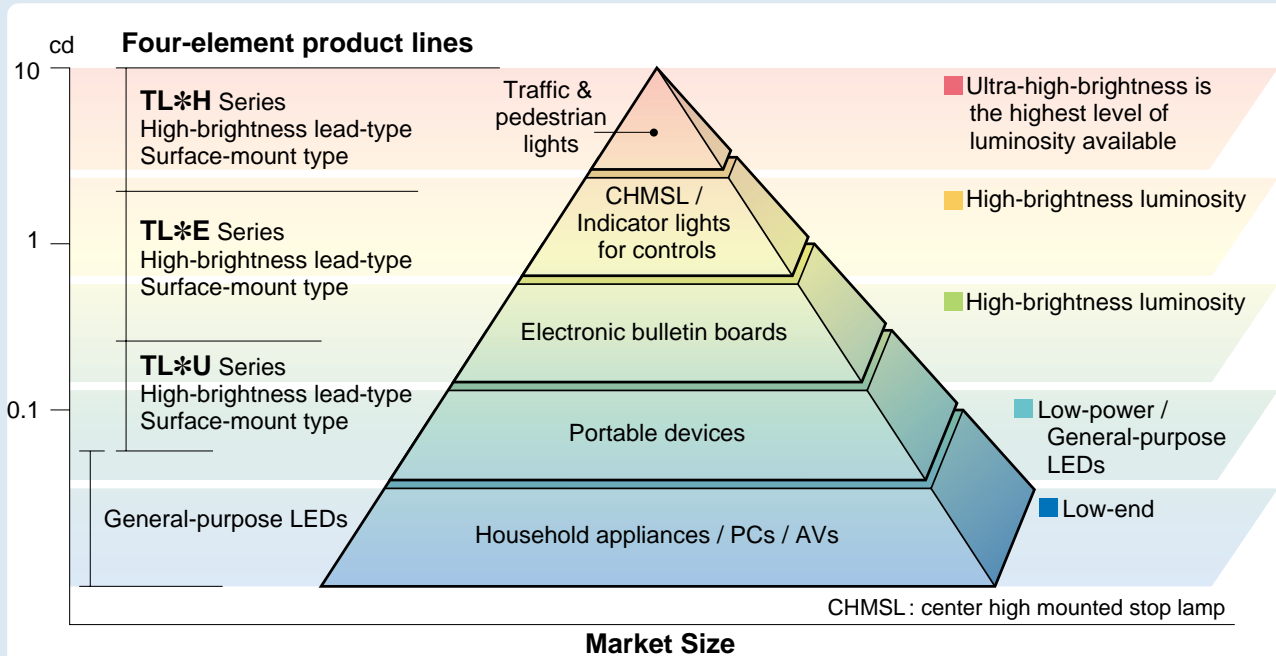

#### Merits of high-brightness LEDs

1. Higher visibility: Visibility is improved in the daytime or in bright environments. Operating status is clear from a distance.
2. Low power dissipation: LED current and circuit power dissipation is reduced compared to these for general-purpose LEDs with the same brightness.
3. Fewer devices required: Number of LEDs needed for backlighting or for multiple LED applications is reduced. Cost of mounting components also reduced.
4. Higher reliability: Product life is prolonged by reduced LED current.

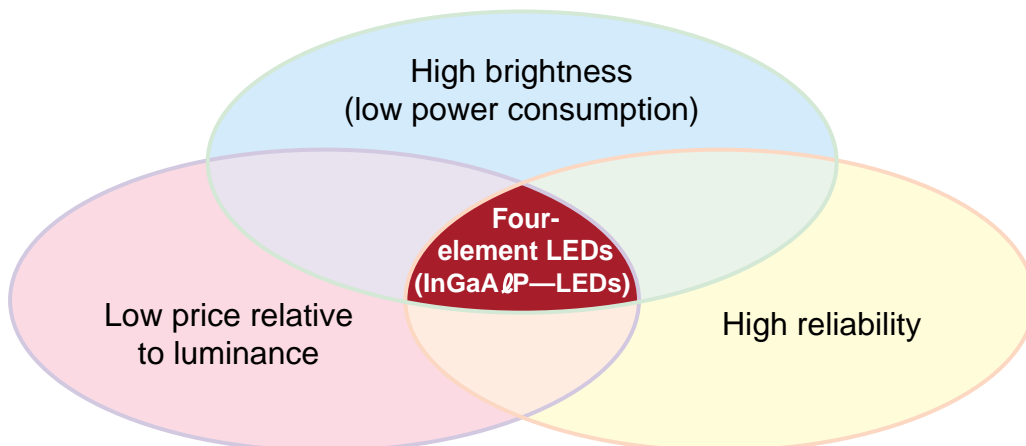

## Comparison between four-element high-brightness LED lamps and general-purpose brightness LEDs

In designing sets that achieve the same luminous intensity through a four-element high-brightness LED lamp as through a general-purpose brightness LED lamp, the use of the four-element high-brightness LED lamp reduces the power dissipation by approximately 90%. (Toshiba internal comparison.)

### (1) Lead type

Comparison: (general-purpose LED) **TLO163**

10° ← Viewing angle

(high-brightness) **TLOH160, TLOE160A**

10°      10° ← Viewing angle

#### ● Typical Luminous Intensity Comparison

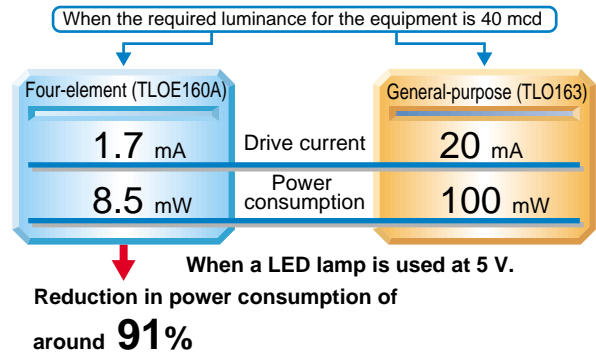
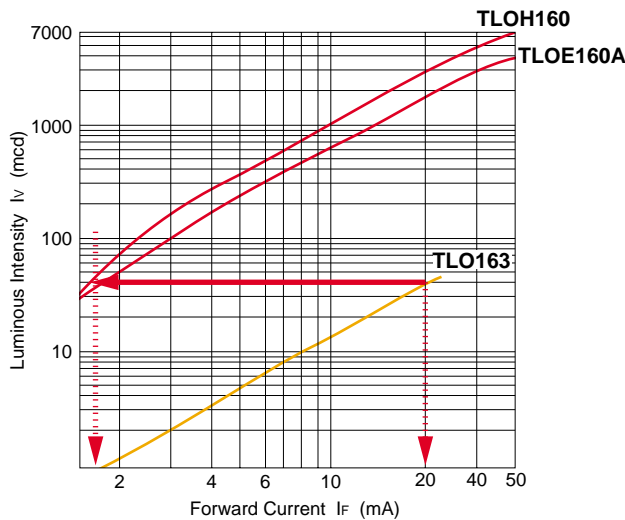

### (2) SMD type

#### ● Four-element LEDs vs. General-purpose LEDs

Example: TLOU1002A vs. TLO1002  
Four-element      General-purpose

#### ● Typical Luminous Intensity Comparison

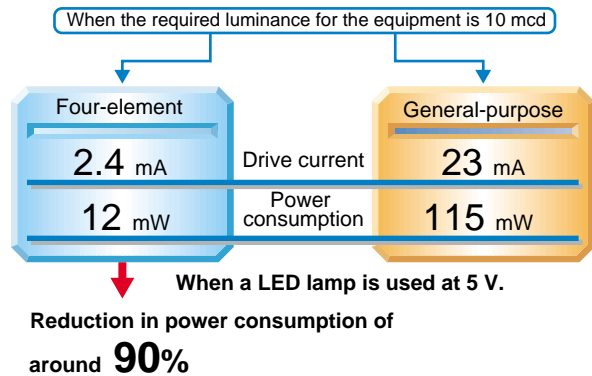
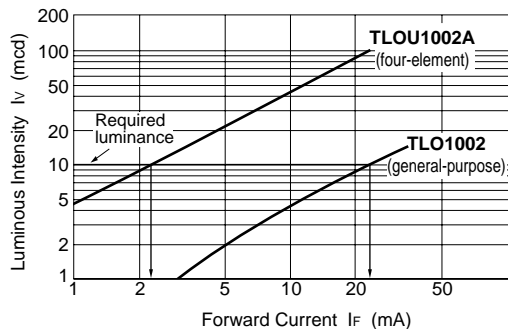

## 4. About the Toshiba InGaAlP LED Lamps

Toshiba are now offering a line-up consisting of several types of unpackaged InGaAlP LED chip, allowing the most appropriate device to be selected for the job at hand. An overview of the line-up is given below. Note that the comparisons are made under the following conditions:  $I_f = 20 \text{ mA}$ ,  $T_a = 25^\circ\text{C}$ .

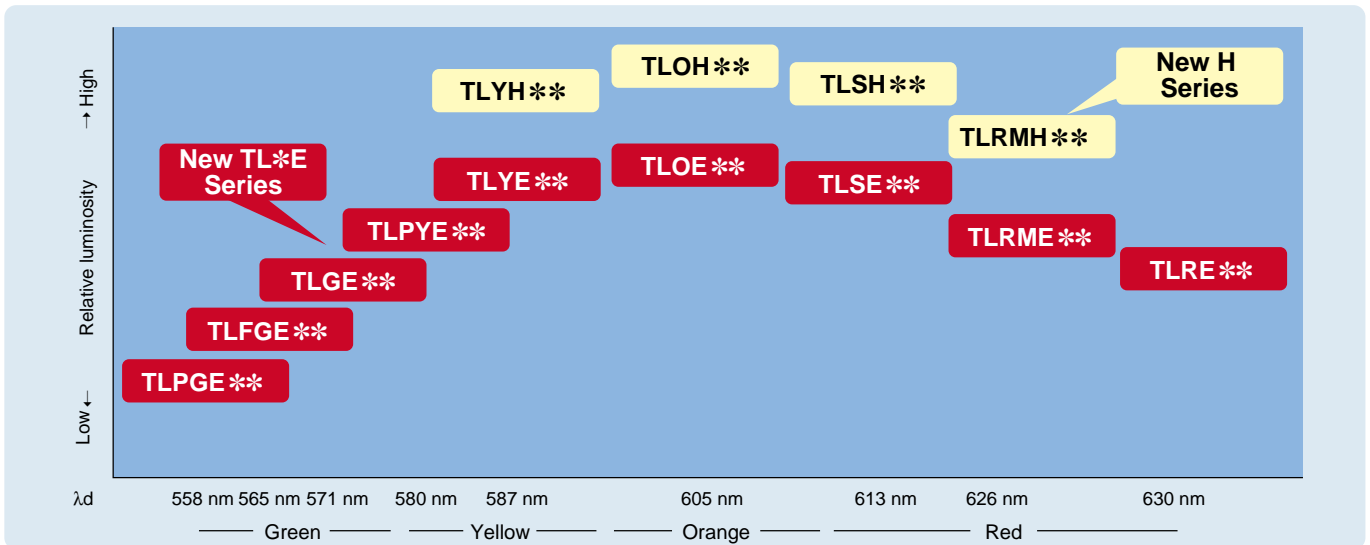

## 5. Emitted-Light Colors and Materials

Emitted-Light Color	Emitted-Light Material	Peak Emission Wavelength (typ.) $\lambda_p$ (nm)		Color Symbol (High-brightness series)
			Dominant $\lambda_d$ (nm)	
Red	InGaAlP	644	630	RH / RE
	InGaAlP	636	626	RMH / RME
	InGaAlP	636	623	SU
	InGaAlP	623	613	SH / SE
Orange	InGaAlP	612	605	OH / OE / OU
Amber	InGaAlP	596	592	AU
Yellow	InGaAlP	590	587	YH / YE / YU
	InGaAlP	583	580	PYE
Green	InGaAlP	574	571	GE
	InGaAlP	568	565	FGE
	InGaAlP	562	558	PGE

### Main Products Typical Spectrum

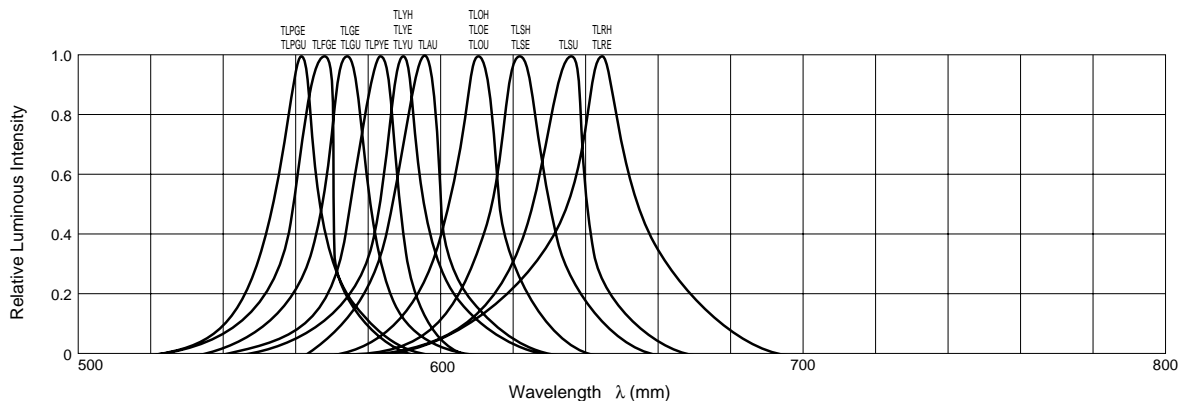

For more details, please refer to each technical data sheet.



## 6. Product Number Format

### Lead Type I (Three digits type)

Product type is determined by color symbol and package type number.

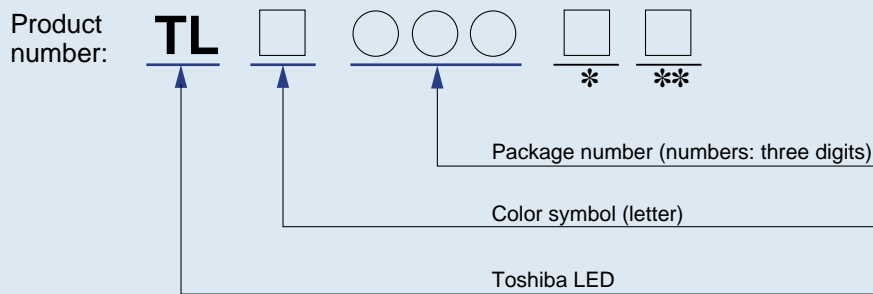

- \* Change code
- \*\* Straight lead type without a lead stopper is indicated by the suffix P which is added at the end of the product number (only applicable to products 5 mm or more in diameter).  
G: Mount flush with PCB.

#### Example: TLRE156AP

This indicates that the product belongs to the high-brightness RE Series, has the package number 156A and is of straight lead type.

#### Example: TLSU113

This indicates that the product belongs to the SU Series, has the package number 113 and has a lead stopper.

### Lead Type II (Two digits type)

Product type is determined by color symbol and package type number.

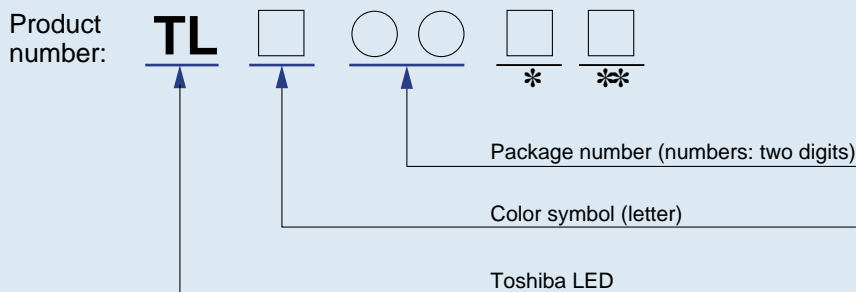

- \* Resin type T: Transparent, C: Colored and transparent, D: Colored and diffusing, M: Milky-white and diffusing
- \*\* Straight lead type without a lead stopper is indicated by the suffix P which is added at the end of the product number (only applicable to products 5 mm or more in diameter).  
G: Mount flush with PCB.

#### Example: TLRME68TG

This indicates that the product belongs to the high-brightness RME Series, has the package number 68 and has a transparent, mount flush with PCB type led lamp.

### SMD Type

Product type is determined by color symbol and package type number.

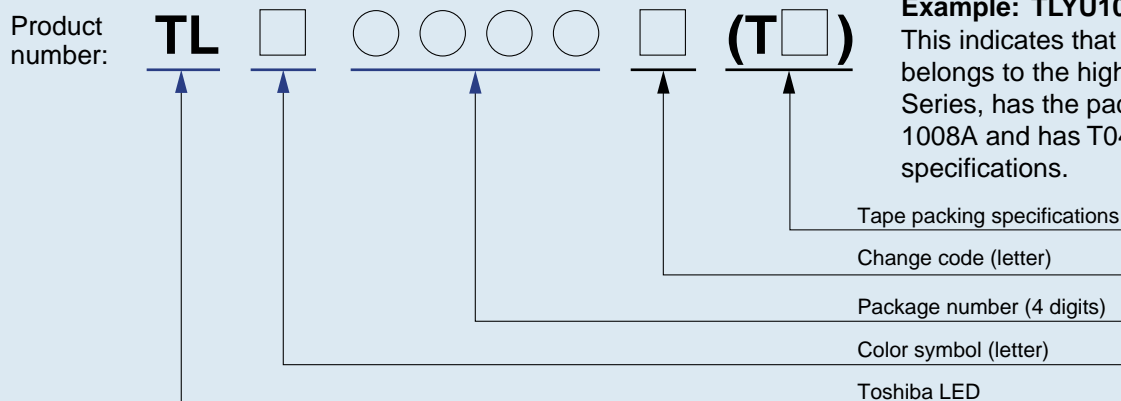

#### Example: TLYU1008A(T04)

This indicates that the product belongs to the high-brightness YU Series, has the package number 1008A and has T04 tape packing specifications.

## 7. Lead-Type Luminous Intensity Classification Table

Rank	Luminous Intensity (mcd)	Rank	Luminous Intensity (mcd)
A	0.1~0.2	M	56~112
B	0.18~0.36	N	100~200
C	0.32~0.64	P	180~360
D	0.56~1.12	Q	320~640
E	1.0~2.0	R	560~1,120
F	1.8~3.6	S	1,000~2,000
G	3.2~6.4	T	1,800~3,600
H	5.6~11.2	U	3,200~6,400
J	10~20	V	5,600~11,200
K	18~36	W	10,000~20,000
L	32~64	X	18,000~36,000
		Y	32,000~64,000

The table to the left provides of high-brightness LED lamp series as common criterion for luminous intensity classification. Measurement tolerance for each limit is  $\pm 15\%$ .

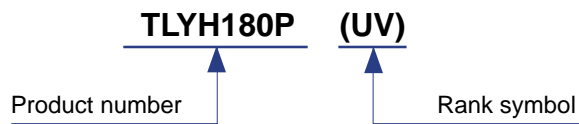

### Luminous Intensity Classification Format (Lead type)

Example:



This example shows that the product is a TLYH180P of ranks U and V. Rank-classified products include two ranking levels as standard.

## 8. Lens Color and Appearance

Lens Type	Transparent	Milky white, Diffusing	Colored, Transparent	Colored, Diffusing
Appearance				

The colored lens type is using the luminescence color.

## 9. Pulse Drive

Since the allowable forward pulse current varies with  $I_F$  max, please refer to the graphs of allowable forward pulse current ratings. Note also that pulse drive requires derating with respect to the ambient temperature, as does DC drive.

**Allowable forward pulse current rating**  
( $T_a = 25^\circ\text{C}$ )

DC Forward $I_F$ max (mA)	Allowable Forward Pulse Current $I_{FPmax}$ (Note 2) (mA)	Characteristic Curves
50	200	1
25	120	2
30		3

Note 1:  
Pulse width  $P_w = 100 \mu\text{s}$ ,  
Duty ratio  $D_R = 10^{-1}$

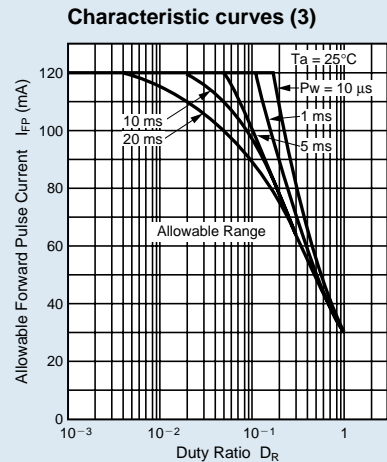
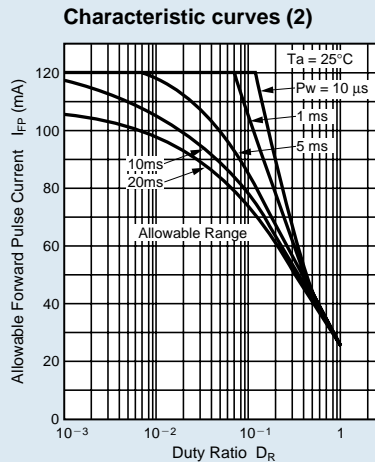
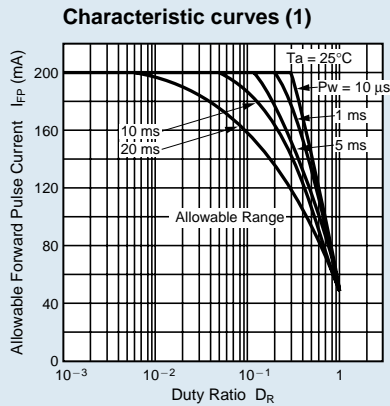

## 10. General LED Characteristics

### Absolute maximum rating

Absolute maximum ratings are the rated specifications which must not be exceeded in any operating environment. Please check the ratings for your intended product before designing a circuit.

### Radiation (viewing) angle

This parameter indicates the ratio of the LED's luminous intensity to its axial luminous intensity (= 100%) as viewed from an angle of  $\theta$  with respect to the axis of the light source. The angle at which luminous intensity is exactly 50% of the axial luminous intensity is called the half-value angle  $\theta_{1/2}$ . The half-value angle on both sides of the axis is expressed as  $2\theta_{1/2}$ .

### Luminous intensity

The light-emitting diode is assumed to be a spot light source and the luminous intensity is defined as the flux of light per unit solid angle for that light source.

The unit of luminous intensity is mcd.

This value is generally higher for the converging type of product which has high directional sensitivity.

### Temperature dependency of luminous intensity

Optical output power decreases as the ambient temperature rises at a rate of approximately 1% per  $^\circ\text{C}$ .

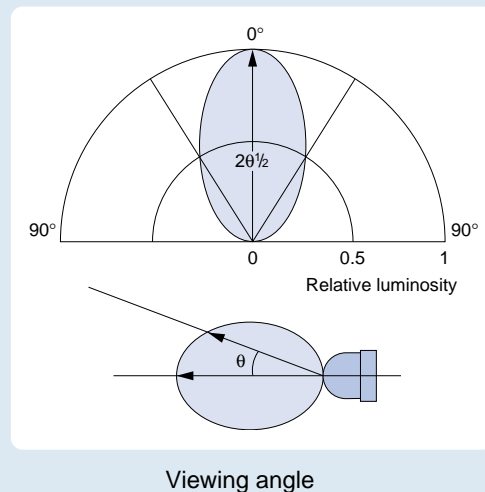

# 3 Product List for Lead Type

## 1. Electrical and Optical Characteristics

Toshiba produces an extensive product line of newly developed ultra-high-brightness red, orange, yellow, green and pure green LEDs using InGaAlP material and optimum lens design. Toshiba high-brightness LED lamps will help you to choose the most suitable type for your application.

### Type I (Three digits type)

Series Name	Absolute Maximum Ratings					Electrical / Optical Characteristics								
	DC forward current I <sub>F</sub> (mA)	DC reverse voltage V <sub>R</sub> (V)	Power dissipation P <sub>D</sub> (mW)	Operating temperature T <sub>opr</sub> (°C)	Storage temperature T <sub>stg</sub> (°C)	Forward voltage V <sub>F</sub> (V)			Reverse current I <sub>R</sub> (μA)		Standard emission wavelength characteristics (nm)			
						typ.	max	I <sub>F</sub> (mA)	max	V <sub>R</sub> (V)	Peak wave-length λ <sub>p</sub>	Half width Δλ	Dominant wavelength λ <sub>d</sub>	I <sub>F</sub> (mA)
TLRH Series	50	4	125	-30~85	-40~120	1.9	2.5	20	50	4	644	18	630	20
TLRMH Series	50	4	125	-40~100	-40~120	2.05	2.5	20	50	4	636	20	626	20
TLRE Series	50	4	125	-30~85	-40~120	1.85	2.4	20	50	4	644	18	630	20
TLSH Series	50	4	125	-30~85	-40~120	2.1	2.5	20	50	4	623	15	613	20
TLSE Series	50	4	125	-30~85	-40~120	1.95	2.4	20	50	4	623	15	613	20
TLSU Series	30	4	72	Note 1	—	2.0	2.4	20	50	4	636	17	623	20
TLOH Series	50	4	125	-30~85	-40~120	2.1	2.5	20	50	4	612	15	605	20
TLOE Series	50	4	125	-30~85	-40~120	1.95	2.4	20	50	4	612	15	605	20
TLOU Series	30	4	72	Note 2	—	2.0	2.4	20	50	4	612	15	605	20
TLYH Series	50	4	125	-30~85	-40~120	2.1	2.5	20	50	4	590	13	587	20
TLYE Series	50	4	125	-30~85	-40~120	2.1	2.5	20	50	4	590	13	587	20
TLYU Series	30	4	75	Note 3	—	2.1	2.5	20	50	4	590	13	587	20
TLGE Series	50	4	140	-30~85	-40~120	2.27	2.8	20	50	4	574	11	571	20
TLPGE Series	50	4	140	-30~85	-40~120	2.27	2.8	20	50	4	562	11	558	20

\* Some individual product specifications may differ from the series specifications given above. Please check the characteristics for each device.

Note 1: For operating and storage temperatures, please see page 14, 15.

Note 2: For operating and storage temperatures, please see page 18, 19.

Note 3: For operating and storage temperatures, please see page 20, 21.

### Type II (Two digits type)

Series Name	Absolute Maximum Ratings					Electrical / Optical Characteristics								
	DC forward current I <sub>F</sub> (mA)	DC reverse voltage V <sub>R</sub> (V)	Power dissipation P <sub>D</sub> (mW)	Operating temperature T <sub>opr</sub> (°C)	Storage temperature T <sub>stg</sub> (°C)	Forward voltage V <sub>F</sub> (V)			Reverse current I <sub>R</sub> (μA)		Standard emission wavelength characteristics (nm)			
						typ.	max	I <sub>F</sub> (mA)	max	V <sub>R</sub> (V)	Peak wave-length λ <sub>p</sub>	Half width Δλ	Dominant wavelength λ <sub>d</sub>	I <sub>F</sub> (mA)
TLRE Series	50	4	120	-40~100	-40~120	1.9	2.4	20	50	4	644	20	630	20
TLRMH Series	50	4	120	-40~100	-40~120	1.9	2.4	20	50	4	636	13	626	20
TLRME Series	50	4	120	-40~100	-40~120	1.9	2.4	20	50	4	636	23	626	20
TLSH Series	50	4	120	-40~100	-40~120	2.0	2.4	20	50	4	623	13	613	20
TLSE Series	50	4	120	-40~100	-40~120	1.9	2.4	20	50	4	623	20	613	20
TLOH Series	50	4	120	-40~100	-40~120	2.0	2.4	20	50	4	612	13	605	20
TLOE Series	50	4	120	-40~100	-40~120	2.0	2.4	20	50	4	612	20	605	20
TLYH Series	50	4	120	-40~100	-40~120	2.0	2.4	20	50	4	590	13	587	20
TLYE Series	50	4	120	-40~100	-40~120	2.0	2.4	20	50	4	590	17	587	20
TLPYE Series	50	4	120	-40~100	-40~120	2.0	2.4	20	50	4	583	14	580	20
TLGE Series	50	4	120	-40~100	-40~120	2.0	2.4	20	50	4	574	17	571	20
TLGU Series	30	4	72	-40~100	-40~120	2.1	2.4	20	50	4	574	17	571	20
TLPGE Series	50	4	120	-40~100	-40~120	2.0	2.4	20	50	4	568	15	565	20
TLPGE Series	50	4	120	-40~100	-40~120	2.1	2.4	20	50	4	562	14	558	20
TLPGU Series	30	4	72	-40~100	-40~120	2.1	2.4	20	50	4	562	14	558	20

\* Some individual product specifications may differ from the series specifications given above. Please check the characteristics for each device.

# 3 Product List for Lead Type

## 2. High-Brightness Red LED Lamps

@Ta = 25°C

Series Name	Package Size (mm)	Viewing Angle 2θ1/2	Intensity I <sub>v</sub> (mcd) @ I <sub>F</sub> = 20 mA		Product Number		Typical Emitting Wavelength		Lens Type	Absolute Maximum Ratings			Package Dimension Number	Typical Applications		
			Min	Typ.	Open rank	Rank specified	λ <sub>d</sub> (nm)	λ <sub>p</sub> (nm)		Guaranteed Temperature	DC Forward Current I <sub>F</sub> (mA)	Pulse Forward Current I <sub>FP</sub> (mA)				
TL*H Series	ø10	4°	4760	19000	TLRH190P	TLRH190P(WX)	630	644	Transparent	*1	50	200	ø10-1	Traffic light		
		7°	4760	11000	NEW TLSH20TP	—	613	623	Transparent	*3	50	200	ø5-1	Pilot lamps (narrow range)		
			2720	9000	NEW TLRMH20TP	—	626	636	Transparent	*3	50	200	ø5-1			
		8°	2720	10000	TLSH180P	TLSH180P(VW)	613	623	Transparent	*1	50	200	ø5-1			
			1530	5000	TLRH180P	TLRH180P(UV)	630	644	Transparent	*1	50	200	ø5-1			
		12°	2720	6500	NEW TLSH38TP	—	613	623	Transparent	*3	50	200	ø5-4			
			1530	4800	NEW TLRMH38TP	—	626	636	Transparent	*3	50	200	ø5-4			
		15°	1530	4200	TLRMH151P	—	626	636	Transparent	*3	50	200	ø5-4			
			20°	1530	4500	NEW TLSH17TP	—	613	623	Transparent	*3	50	200	ø5-2		
		ø5		20°	850	3200	NEW TLRMH17TP	—	626	636	Transparent	*3	50	200	ø5-2	Message board Backlighting
	850		2700		TLSH157P	TLSH157P(ST)	613	623	Transparent	*1	50	200	ø5-2			
	22°		850	2240	TLRMH157P	—	626	636	Transparent	*3	50	200	ø5-2			
			476	1700	TLRH157P	TLRH157P(ST)	630	644	Transparent	*1	50	200	ø5-2			
	25°		850	1900	NEW TLSH16TP	—	613	623	Transparent	*3	50	200	ø5-3			
			476	1500	NEW TLRMH16TP	—	626	636	Transparent	*3	50	200	ø5-3			
	30°		476	900	TLRMH156P	—	626	636	Transparent	*3	50	200	ø5-3			
			476	1400	TLSH156P	TLSH156P(RS)	613	623	Transparent	*1	50	200	ø5-3			
	35°		272	800	TLRH156P	TLRH156P(QR)	630	644	Transparent	*1	50	200	ø5-3			
			272	650	TLRMH265P	—	626	636	Milky-white, diffusing	*3	50	200	ø5-3			
	ø3	10°	2720	4500	TLSH160	—	613	623	Transparent	*1	50	200	ø3-3	Pilot lamps		
850			1800	TLRH160	TLRH160(ST)	630	644	Transparent	*1	50	200	ø3-3				
40°		272	800	TLSH125	—	613	623	Transparent	*1	50	200	ø3-4				
ø3	80°	85	220	TLRH262	TLRH262(NP)	630	644	Transparent	*1	50	200	ø3-2	Message board (wide range)			
		153	450	TLRH247	TLRH247(PQ)	630	644	Transparent	*1	50	200	Elliptical-1	Message board			
TL*U Series	ø5	30°/60°	153	450	TLRH247	TLRH247(PQ)	630	644	Transparent	*1	50	200	Elliptical-1	Message board		
			ø5	6°	1530	4500	TLSU180P	TLSU180P(TU)	623	636	Transparent	*1	30	120	ø5-1	Pilot lamps (narrow range)
				20°	272	900	TLSU156P	TLSU156P(QR)	623	636	Transparent	*1	30	120	ø5-3	Message board Backlighting
	30°	153		550	TLSU113P	—	623	636	Red, transparent	*2	30	120	ø5-5			
	40°	47.6	250	TLSU114P	TLSU114P(NP)	623	636	Red, diffusing	*2	30	120	ø5-5				
	ø3	9°	476	4000	TLSU163	—	623	636	Pale red, transparent	*1	30	120	ø3-3	Pilot lamps		
			476	1600	TLSU160	—	623	636	Transparent	*1	30	120	ø3-3			
		18°	153	450	TLSU164	—	623	636	Pale red, diffusing	*1	30	120	ø3-3			
			153	300	TLSU125	TLSU125(PQ)	623	636	Transparent	*1	30	120	ø3-4			
		35°	85	270	TLSU123	TLSU123(PQ)	623	636	Red, transparent	*2	30	120	ø3-4			
			85	180	TLSU126	—	623	636	Milky-white, diffusing	*1	30	120	ø3-4			
		40°	47.6	100	TLSU124	TLSU124(MN)	623	636	Red, diffusing	*2	30	120	ø3-4			
			47.6	170	TLSU262	TLSU262(NP)	623	636	Transparent	*1	30	120	ø3-2			
		80°	47.6	130	NEW TLSU268G◆	—	623	636	Transparent	*1	30	120	ø3-5		Backlighting (wide range)	

◆: Mount flush with PCB

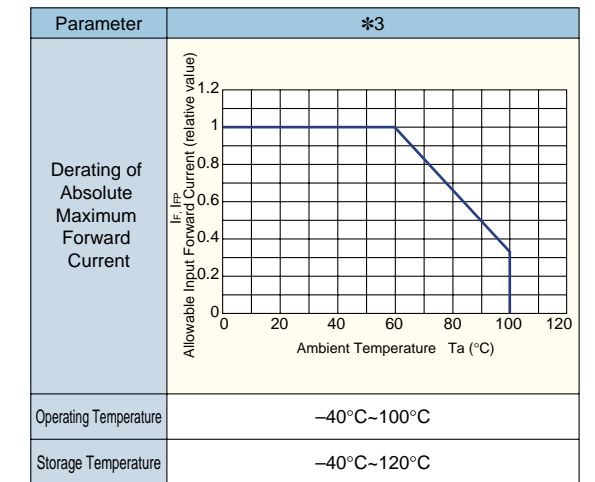
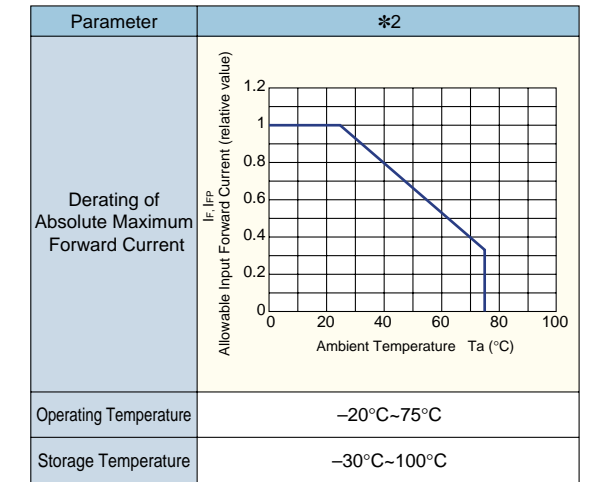
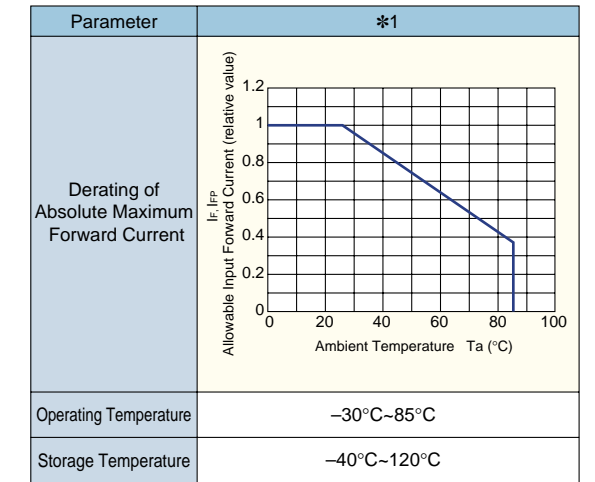

# 3 Product List for Lead Type

## 2. High-Brightness Red LED Lamps

@Ta = 25°C

Series Name	Package Size (mm)	Viewing Angle 2θ1/2	Intensity I <sub>v</sub> (mcd) @I <sub>F</sub> = 20 mA		Product Number		Typical Emitting Wavelength		Lens Type	Absolute Maximum Ratings			Package Dimension Number	Typical Applications	
			Min	Typ.	Open rank	Rank specified	λ <sub>d</sub> (nm)	λ <sub>p</sub> (nm)		Guaranteed Temperature	DC Forward Current I <sub>F</sub> (mA)	Pulse Forward Current I <sub>FP</sub> (mA)			
TL*E Series	ø5	7°	2720	9000	TLSE20TP	—	613	623	Transparent	*3	50	200	ø5-1	Pilot lamps (narrow range)	
			2720	8000	TLRME20TP	—	626	636	Transparent	*3	50	200	ø5-1		
			2720	7000	TLRE20TP	—	630	644	Transparent	*3	50	200	ø5-1		
		8°	1530	8000	TLSE180P	—	613	623	Transparent	*1	50	200	ø5-1		Message board Backlighting
			850	3000	TLRE180AP	TLRE180AP(TU)	630	644	Transparent	*1	50	200	ø5-1		
		20°	850	3000	TLSE17TP	—	613	623	Transparent	*3	50	200	ø5-2		Backlighting (wide range)
			850	2400	TLRME17TP	—	626	636	Transparent	*3	50	200	ø5-2		
			476	1500	TLRE17TP	—	630	644	Transparent	*3	50	200	ø5-2		
		85	270	TLRE138P	—	630	644	Red, diffusing	*1	50	200	ø5-2			
		22°	476	1900	TLSE157P	TLSE157P(ST)	613	623	Transparent	*1	50	200	ø5-2		
			272	1000	TLRE157AP	TLRE157AP(RS)	630	644	Transparent	*1	50	200	ø5-2		
		25°	476	1500	TLSE16TP	—	613	623	Transparent	*3	50	200	ø5-3	Message board Backlighting	
			476	1000	TLSE16CP	—	613	623	Red, transparent	*3	50	200	ø5-3		
			272	1200	TLRME16TP	—	626	636	Transparent	*3	50	200	ø5-3		
			272	800	TLRE16TP	—	630	644	Transparent	*3	50	200	ø5-3		
			153	600	TLRE16CP	—	630	644	Red, transparent	*3	50	200	ø5-3		
		30°	153	500	TLRME17DP	—	626	636	Red, diffusing	*3	50	200	ø5-2	Backlighting (wide range)	
			272	900	TLSE156P	TLSE156P(RS)	613	623	Transparent	*1	50	200	ø5-3		
	153	450	TLRE156AP	TLRE156AP(PQ)	630	644	Transparent	*1	50	200	ø5-3	Backlighting (wide range)			
	75°	47.6	150	TLRE25TP	—	613	644	Transparent	*3	50	200		ø5-6		
	90°	27.2	80	TLRE263AP	TLRE263AP(MN)	630	644	Transparent	*1	50	200	ø5-6	Backlighting (wide range)		
	130°	8.5	20	TLRE11TP	—	613	644	Transparent	*3	50	200	ø5-7			
	150°	8.5	15	TLRE261AP	—	630	644	Transparent	*1	50	200	ø5-7	Backlighting (wide range)		
	ø3	10°	476	1200	TLRE160A	TLRE160A(RS)	630	644	Transparent	*1	50	200		ø3-3	Pilot lamps
1530			3500	TLSE50T	—	613	623	Transparent	*3	50	200	ø3-3			
850			2200	TLRME50T	—	626	636	Transparent	*3	50	200	ø3-3			
16°		850	1800	TLRE50T	—	630	644	Transparent	*3	50	200	ø3-3	Pilot lamps		
		272	800	TLSE53T	—	613	623	Transparent	*3	50	200	ø3-4			
45°		272	600	TLRME53T	—	626	636	Transparent	*3	50	200	ø3-4	Pilot lamps		
		153	400	TLRE53T	—	630	644	Transparent	*3	50	200	ø3-4			
		85	330	NEW TLRME68TG◆	—	626	636	Transparent	*3	50	200	ø3-5			
80°		85	200	TLSE62T	—	613	623	Transparent	*3	50	200	ø3-2	Backlighting (wide range)		
		47.6	180	TLRME62T	—	626	636	Transparent	*3	50	200	ø3-2			
		47.6	150	TLRE262A	TLRE262A(MN)	630	644	Transparent	*1	50	200	ø3-2			
		47.6	120	TLRE62T	—	630	644	Transparent	*3	50	200	ø3-2			
	15.3	45	TLRE60T	—	630	644	Transparent	*3	50	200	ø3-1				
120°	15.3	45	TLRE60T	—	630	644	Transparent	*3	50	200	ø3-1	Backlighting (wide range)			
140°	8.5	25	TLRE260A	—	630	644	Transparent	*1	50	200	ø3-1				
Elliptical 5 X 5.8	30°/50°	272	750	TLSE27C	—	613	623	Red, transparent	*3	50	200	Elliptical-1	Message board		
		153	400	TLRME27C	—	626	636	Red, transparent	*3	50	200	Elliptical-1			
		85	300	TLRE27C	—	630	644	Red, transparent	*3	50	200	Elliptical-1			
	30°/60°	85	350	TLRE248	—	630	644	Red, transparent	*1	50	200	Elliptical-1			

◆: Mount flush with PCB

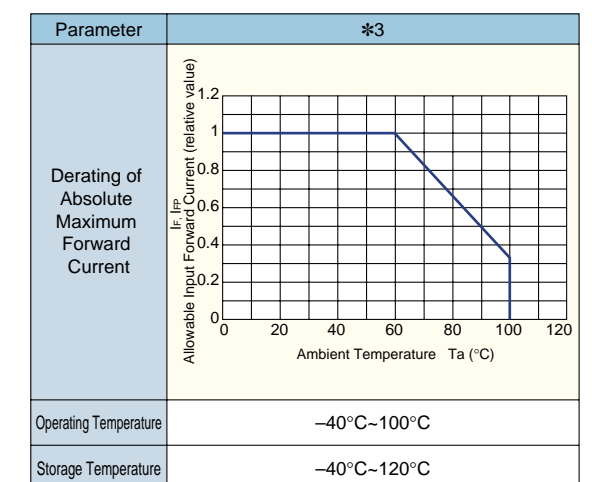
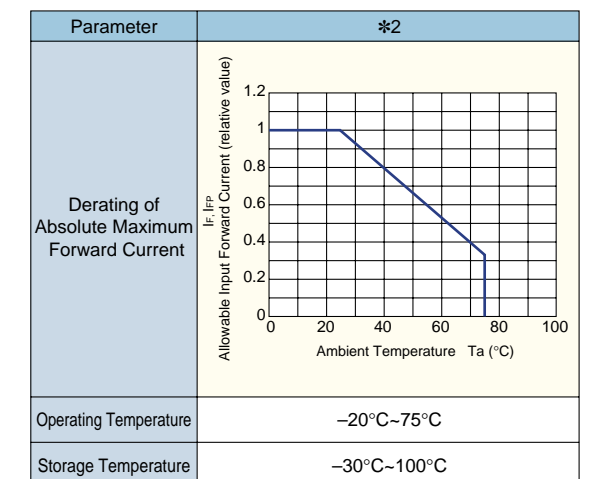
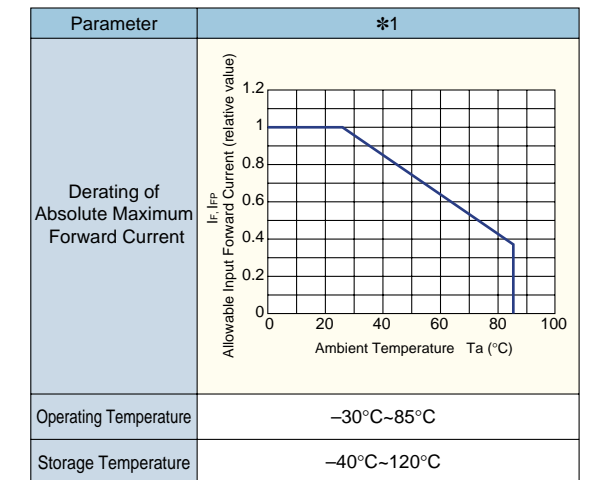

# 3 Product List for Lead Type

## 3. High-Brightness Orange LED Lamps

@Ta = 25°C

Series Name	Package Size (mm)	Viewing Angle 2θ1/2	Intensity I <sub>v</sub> (mcd) @ I <sub>F</sub> = 20 mA		Product Number		Typical Emitting Wavelength		Lens Type	Absolute Maximum Ratings			Package Dimension Number	Typical Applications
			Min	Typ.	Open rank	Rank specified	λ <sub>d</sub> (nm)	λ <sub>p</sub> (nm)		Guaranteed Temperature	DC Forward Current I <sub>F</sub> (mA)	Pulse Forward Current I <sub>FP</sub> (mA)		
TL*H Series	ø10	4°	8500	33000	TLOH190P	TLOH190P(XY)	605	612	Transparent	*1	50	200	ø10-1	Traffic light
		7°	4760	15000	NEW TLOH20TP	—	605	612	Transparent	*3	50	200	ø5-1	Pilot lamps (narrow range)
	8°	2720	10000	TLOH180P	TLOH180P(VW)	605	612	Transparent	*1	50	200	ø5-1		
	12°	2720	7500	NEW TLOH38TP	—	605	612	Transparent	*3	50	200	ø5-4		
	ø5	20°	1530	5000	NEW TLOH17TP	—	605	612	Transparent	*3	50	200	ø5-2	Message board Backlighting
		22°	850	2800	TLOH157P	TLOH157P(TU)	605	612	Transparent	*1	50	200	ø5-2	
		25°	850	2300	NEW TLOH16TP	—	605	612	Transparent	*3	50	200	ø5-3	
		30°	476	1500	TLOH156P	TLOH156P(ST)	605	612	Transparent	*1	50	200	ø5-3	
		ø3	10°	850	2300	TLOH160	TLOH160(TU)	605	612	Transparent	*1	50	200	ø3-3
	80°		153	450	TLOH262	TLOH262(PQ)	605	612	Transparent	*1	50	200	ø3-2	Backlighting (wide range)
TL*E Series	ø5	7°	4760	10000	TLOE20TP	—	605	612	Transparent	*3	50	200	ø5-1	Pilot lamps (narrow range)
		8°	1530	7000	TLOE180AP	TLOE180AP(UV)	605	612	Transparent	*1	50	200	ø5-1	
		20°	1530	4500	TLOE17TP	—	605	612	Transparent	*3	50	200	ø5-2	Message board Backlighting
		22°	476	2800	TLOE157AP	TLOE157AP(ST)	605	612	Transparent	*1	50	200	ø5-2	
		25°	850	2000	TLOE16TP	—	605	612	Transparent	*3	50	200	ø5-3	
			476	1600	TLOE16CP	—	605	612	Orange, transparent	*3	50	200	ø5-3	
		30°	272	1000	TLOE156AP	TLOE156AP(RS)	605	612	Transparent	*1	50	200	ø5-3	
			272	900	TLOE266	TLOE266(RS)	605	612	Orange, transparent	*1	50	200	ø5-8	
		75°	153	350	TLOE25TP	—	605	612	Transparent	*3	50	200	ø5-6	Backlighting (wide range)
		90°	47.6	260	TLOE263AP	TLOE263AP(PQ)	605	612	Transparent	*1	50	200	ø5-6	
	130°	27.2	65	TLOE11TP	—	605	612	Transparent	*3	50	200	ø5-7		
	150°	15.3	50	TLOE261AP	TLOE261AP(LM)	605	612	Transparent	*1	50	200	ø5-7		
	ø3	10°	476	1500	TLOE160A	TLOE160A(ST)	605	612	Transparent	*1	50	200	ø3-3	Pilot lamps
		16°	1530	4500	TLOE50T	—	605	612	Transparent	*3	50	200	ø3-3	Backlighting (wide range)
		45°	272	1000	TLOE53T	—	605	612	Transparent	*3	50	200	ø3-4	
		80°	153	350	TLOE62T	—	605	612	Transparent	*3	50	200	ø3-2	
		80°	85	300	TLOE262A	TLOE262A(PQ)	605	612	Transparent	*1	50	200	ø3-2	
		120°	27.2	100	TLOE60T	—	605	612	Transparent	*3	50	200	ø3-1	
		140°	15.3	70	TLOE260A	TLOE260A(LM)	605	612	Transparent	*1	50	200	ø3-1	
Elliptical 5 X 5.8	30°/50°	272	800	TLOE27C	—	605	612	Orange, transparent	*3	50	200	Elliptical-1	Message board	
	30°/60°	153	370	TLOE248	—	605	612	Orange, transparent	*1	50	200	Elliptical-1		
TL*U Series	ø5	6°	2720	7000	TLOU180P	TLOU180P(UV)	605	612	Transparent	*1	30	120	ø5-1	Pilot lamps (narrow range)
		20°	476	900	TLOU156P	TLOU156P(RS)	605	612	Transparent	*1	30	120	ø5-3	
			476	800	TLOU172P	—	605	612	Orange, transparent	*1	30	120	ø5-3	
		30°	272	900	TLOU113P	TLOU113P(RS)	605	612	Orange, transparent	*2	30	120	ø5-5	Message board Backlighting
	40°	47.6	250	TLOU114P	TLOU114P(NP)	605	612	Orange, diffusing	*2	30	120	ø5-5		
	ø3	9°	476	2500	TLOU160	—	605	612	Transparent	*1	30	120	ø3-3	Pilot lamps
		35°	85	400	TLOU123	—	605	612	Orange, transparent	*2	30	120	ø3-4	
		40°	47.6	180	TLOU124	—	605	612	Orange, diffusing	*2	30	120	ø3-4	
		60°	47.6	300	TLOU262	TLOU262(PQ)	605	612	Transparent	*1	30	120	ø3-2	Backlighting (wide range)
	47.6		200	TLOU267	—	605	612	Orange, transparent	*1	30	120	ø3-2		
Elliptical 5 X 5.8	30°/45°	85	450	TLOU248	—	605	612	Orange, transparent	*1	30	120	Elliptical-1	Message board	

◆: Mount flush with PCB

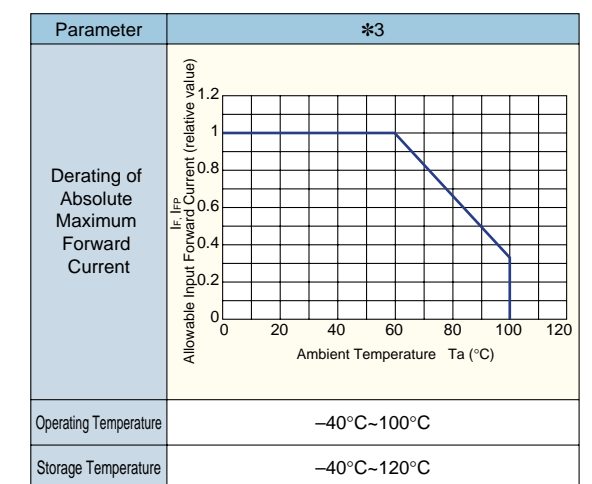
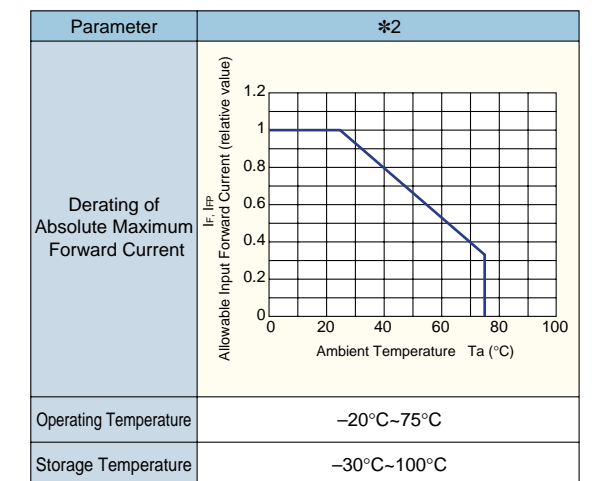
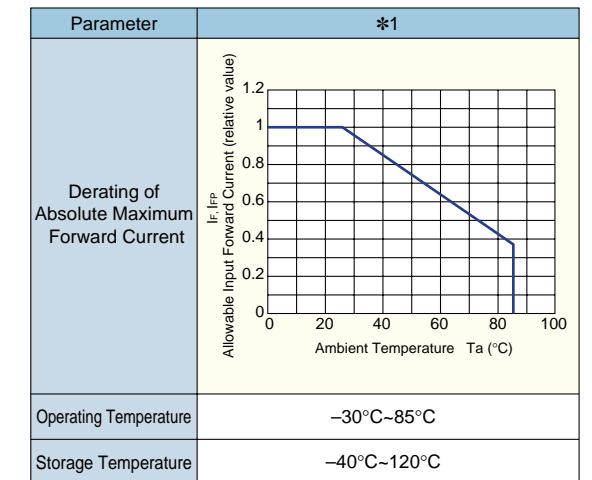

# 3 Product List for Lead Type

## 4. High-Brightness Yellow LED Lamps

@Ta = 25°C

Series Name	Package Size (mm)	Viewing Angle 2θ1/2	Intensity I <sub>v</sub> (mcd) @I <sub>F</sub> = 20 mA		Product Number		Typical Emitting Wavelength		Lens Type	Absolute Maximum Ratings			Package Dimension Number	Typical Applications	
			Min	Typ.	Open rank	Rank specified	λ <sub>d</sub> (nm)	λ <sub>p</sub> (nm)		Guaranteed Temperature	DC Forward Current I <sub>F</sub> (mA)	Pulse Forward Current I <sub>FP</sub> (mA)			
TL*H Series	ø10	4°	8500	30000	TLYH190P	TLYH190P(XY)	587	590	Transparent	*1	50	200	ø10-1	Traffic light	
		7°	4760	13000	NEW TLYH20TP	—	587	590	Transparent	*3	50	200	ø5-1	Pilot lamps (narrow range)	
	8°	2720	8000	TLYH180P	TLYH180P(VW)	587	590	Transparent	*1	50	200	ø5-1			
	12°	2720	7000	NEW TLYH38TP	—	587	590	Transparent	*3	50	200	ø5-4			
	15°	2200	4500	TLYH151P	—	587	590	Transparent	*1	50	200	ø5-4			
	ø5	20°	1530	4800	NEW TLYH17TP	—	587	590	Transparent	*3	50	200	ø5-2	Message board Backlighting	
		22°	850	2500	TLYH157P	TLYH157P(TU)	587	590	Transparent	*1	50	200	ø5-2		
		25°	850	2200	NEW TLYH16TP	—	587	590	Transparent	*3	50	200	ø5-3		
		ø3	10°	850	4300	TLYH160	TLYH160(TU)	587	590	Transparent	*1	50	200	ø3-3	Pilot lamps
			80°	85	280	TLYH262	TLYH262(PQ)	587	590	Transparent	*1	50	200	ø3-2	Backlighting (wide range)
Elliptical 5 X 5.8		60°/30°	153	700	TLYH247	TLYH247(QR)	587	590	Transparent	*1	50	200	Elliptical-1	Message board	
TL*E Series	ø5	5°	2720	8000	NEW TLPYE23TP	—	580	583	Transparent	*3	50	200	ø5-9	Pilot lamps (narrow range)	
		7°	2720	9500	TLYE20TP	—	587	590	Transparent	*3	50	200	ø5-1		
		8°	1530	4700	TLYE180AP	TLYE180AP(UV)	587	590	Transparent	*1	50	200	ø5-1		
		18°	476	2000	NEW TLPYE19TP	—	580	583	Transparent	*3	50	200	ø5-10		
		20°	850	3000	TLYE17TP	—	587	590	Transparent	*3	50	200	ø5-2	Message board Backlighting	
		22°	476	2200	TLYE157AP	TLYE157AP(ST)	587	590	Transparent	*1	50	200	ø5-2		
		25°	476	1500	TLYE16TP	—	587	590	Transparent	*3	50	200	ø5-3		
			476	1200	TLYE16CP	—	587	590	Yellow, transparent	*3	50	200	ø5-3		
		30°	272	750	NEW TLPYE18TP	—	580	583	Transparent	*3	50	200	ø5-12		
		272	700	TLYE156AP	TLYE156AP(QR)	587	590	Transparent	*1	50	200	ø5-3			
		75°	85	300	TLYE25TP	—	587	590	Transparent	*3	50	200	ø5-6	Backlighting (wide range)	
		90°	47.6	170	TLYE263AP	TLYE263AP(NP)	587	590	Transparent	*1	50	200	ø5-6		
	130°	15.3	45	TLYE11TP	—	587	590	Transparent	*3	50	200	ø5-7			
	ø3	150°	8.5	27	TLYE261AP	TLYE261AP(JK)	587	590	Transparent	*1	50	200	ø5-7	Pilot lamps	
		10°	476	2300	TLYE160A	TLYE160A(ST)	587	590	Transparent	*1	50	200	ø3-3		
		16°	1530	3500	TLYE50T	—	587	590	Transparent	*3	50	200	ø3-3		
			850	2500	NEW TLPYE50T	—	580	583	Transparent	*3	50	200	ø3-3		
		45°	272	800	TLYE53T	—	587	590	Transparent	*3	50	200	ø3-4		
			153	450	NEW TLPYE53T	—	580	583	Transparent	*3	50	200	ø3-4		
80°		85	340	NEW TLYE68TG◆	—	587	590	Transparent	*3	50	200	ø3-5	Backlighting (wide range)		
		85	250	TLYE62T	—	587	590	Transparent	*3	50	200	ø3-2			
		85	240	TLYE262A	TLYE262A(NP)	587	590	Transparent	*1	50	200	ø3-2			
		47.6	150	NEW TLPYE62T	—	580	583	Transparent	*3	50	200	ø3-2			
120°	27.2	85	TLYE60T	—	587	590	Transparent	*3	50	200	ø3-1	Message board			
140°	15.3	40	TLYE260A	TLYE260A(KL)	587	590	Transparent	*1	50	200	ø3-1				
Elliptical 5 X 5.8	30°/50°	272	650	TLYE27C	—	587	590	Yellow, transparent	*3	50	200	Elliptical-1			
TL*U Series	ø5	6°	850	4300	TLYU180P	TLYU180P(TU)	587	590	Transparent	*1	30	120	ø5-1	Pilot lamps (narrow range)	
		20°	153	500	TLYU156P	TLYU156P(QR)	587	590	Transparent	*1	30	120	ø5-3		
			153	400	TLYU172P	—	587	590	Yellow, transparent	*1	30	120	ø5-3		
		30°	153	500	TLYU113P	—	587	590	Yellow, transparent	*2	30	120	ø5-5	Message board Backlighting	
	40°	47.6	130	TLYU114P	TLYU114P(MN)	587	590	Yellow, diffusing	*2	30	120	ø5-5	Pilot lamps		
	35°	85	220	TLYU123	TLYU123(NP)	587	590	Yellow, transparent	*2	30	120	ø3-4			
	40°	47.6	110	TLYU124	TLYU124(MN)	587	590	Yellow, diffusing	*2	30	120	ø3-4			
	60°	47.6	150	TLYU262	TLYU262(MN)	587	590	Transparent	*1	30	120	ø3-2			
		47.6	90	TLYU267	—	587	590	Yellow, transparent	*1	30	120	ø3-2			
90°	476	1500	TLYU160	TLYU160(ST)	587	590	Transparent	*1	30	120	ø3-3	Backlighting (wide range)			

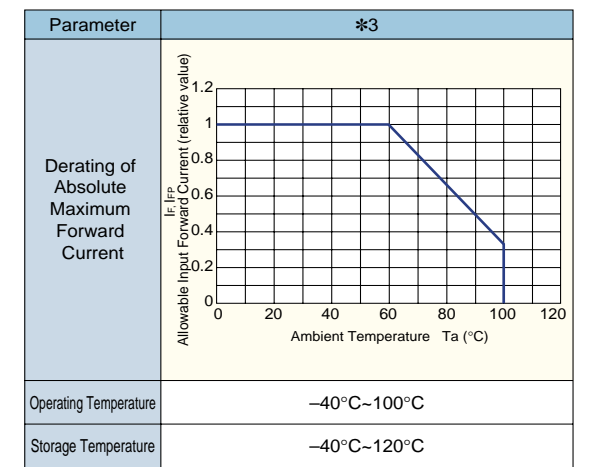
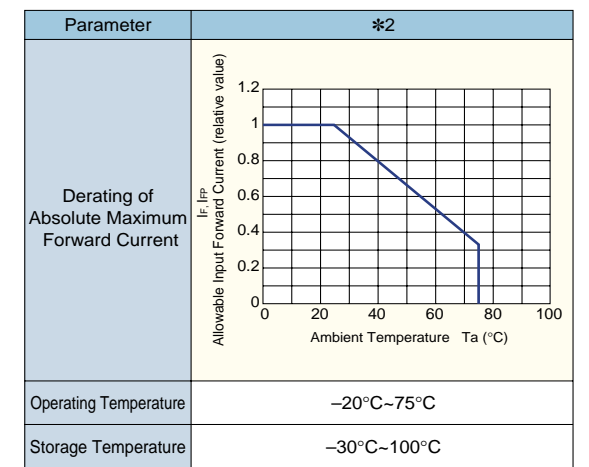
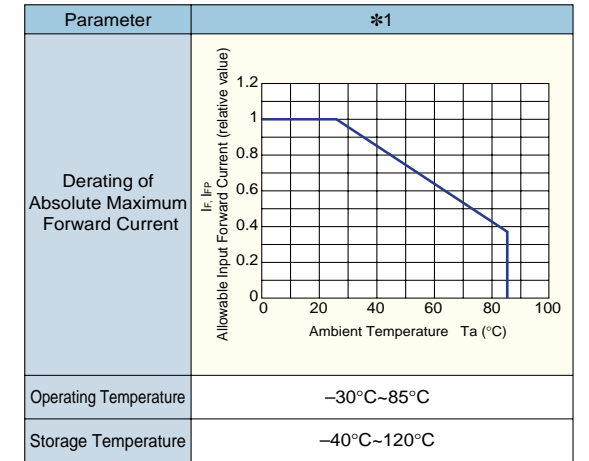

◆: Mount flush with PCB



# 3 Product List for Lead Type

## 5. High-Brightness Green LED Lamps

@Ta = 25°C

Series Name	Package Size (mm)	Viewing Angle 2θ1/2	Intensity I <sub>v</sub> (mcd) @ I <sub>F</sub> = 20 mA		Product Number		Typical Emitting Wavelength		Lens Type	Absolute Maximum Ratings			Package Dimension Number	Typical Applications
			Min	Typ.	Open rank	Rank specified	λ <sub>d</sub> (nm)	λ <sub>p</sub> (nm)		Guaranteed Temperature	DC Forward Current I <sub>F</sub> (mA)	Pulse Forward Current I <sub>FP</sub> (mA)		
TL*E Series	ø5	5°	2720	7000	TLGE23TP	—	571	574	Transparent	*3	50	200	ø5-9	Pilot lamps (narrow range)
			850	3000	TLPGE23TP	—	558	562	Transparent	*3	50	200	ø5-9	
			1530	5000	NEW TLFGE23TP	—	565	568	Transparent	*3	50	200	ø5-9	
		7°	1530	5000	TLGE183P	—	571	574	Transparent	*1	50	200	ø5-9	
			476	2000	TLPGE183P	TLPGE183P(ST)	558	562	Transparent	*1	50	200	ø5-9	
		18°	476	1300	TLGE19TP	—	571	574	Transparent	*3	50	200	ø5-10	
			272	800	NEW TLFGE19TP	—	565	568	Transparent	*3	50	200	ø5-10	
			153	500	TLPGE19TP	—	558	562	Transparent	*3	50	200	ø5-10	
		20°	476	1700	TLGE159P	TLGE159P(ST)	571	574	Transparent	*1	50	200	ø5-10	
			476	1400	TLGE174P	—	571	574	Green, transparent	*1	50	200	ø5-11	
			153	430	TLPGE159P	—	558	562	Transparent	*1	50	200	ø5-10	
		28°	272	800	TLGE158P	TLGE158P(QR)	571	574	Transparent	*1	50	200	ø5-12	
			85	150	TLPGE158P	—	558	562	Transparent	*1	50	200	ø5-12	
		30°	85	300	NEW TLFGE18TP	—	565	568	Transparent	*3	50	200	ø5-12	
			272	700	TLGE18TP	—	571	574	Transparent	*3	50	200	ø5-12	
			153	500	TLGE18CP	—	571	574	Green, transparent	*3	50	200	ø5-12	
	85		200	TLPGE18TP	—	558	562	Transparent	*3	50	200	ø5-12		
	75°	27.2	90	TLGE25TP	—	571	574	Transparent	*3	50	200	ø5-6		
	130°	8.5	20	TLGE11TP	—	571	574	Transparent	*3	50	200	ø5-7		
		2.72	8	TLPGE11TP	—	558	562	Transparent	*3	50	200	ø5-7		
	ø3	9°	850	2400	TLGE160	TLGE160(TU)	571	574	Transparent	*1	50	200	ø3-3	Pilot lamps
			272	450	TLPGE160	—	558	562	Transparent	*1	50	200	ø3-3	
		16°	476	1500	TLGE50T	—	571	574	Transparent	*3	50	200	ø3-3	
			272	1000	NEW TLFGE50T	—	565	568	Transparent	*3	50	200	ø3-3	
			153	600	TLPGE50T	—	558	562	Transparent	*3	50	200	ø3-3	
		35°	153	500	TLGE125	TLGE125(QR)	571	574	Transparent	*1	50	200	ø3-4	
			153	450	TLGE123	TLGE123(PQ)	571	574	Green, transparent	*1	50	200	ø3-4	
		45°	47.6	150	TLPGE125	—	558	562	Transparent	*1	50	200	ø3-4	
			153	400	TLGE53T	—	571	574	Transparent	*3	50	200	ø3-4	
			85	200	NEW TLFGE53T	—	565	568	Transparent	*3	50	200	ø3-4	
		65°	47.6	130	TLPGE53T	—	558	562	Transparent	*3	50	200	ø3-4	
			47.6	220	TLGE262	TLGE262(NP)	571	574	Transparent	*1	50	200	ø3-2	
	80°	15.3	45	TLPGE262	—	558	562	Transparent	*1	50	200	ø3-2		
		47.6	155	NEW TLGE68TG◆	—	571	574	Transparent	*3	50	200	ø3-5		
		47.6	110	TLGE62T	—	571	574	Transparent	*3	50	200	ø3-2		
		27.2	70	NEW TLFGE62T	—	565	568	Transparent	*3	50	200	ø3-2		
	120°	15.3	45	TLPGE62T	—	558	562	Transparent	*3	50	200	ø3-2		
		15.3	50	TLGE60T	—	571	574	Transparent	*3	50	200	ø3-1		
		8.5	45	TLGE260	TLGE260(KL)	571	574	Transparent	*1	50	200	ø3-1		
	Elliptical 5 X 5.8	30°/50°	85	250	TLGE27C	—	571	574	Green, transparent	*3	50	200	Elliptical-1	Message board
153			400	TLGE247	TLGE247(PQ)	571	574	Transparent	*1	50	200	Elliptical-1		
60°/30°		153	360	TLGE248	—	571	574	Green, transparent	*1	50	200	Elliptical-1		
		27.2	90	TLPGE247	TLPGE247(LM)	558	562	Transparent	*1	50	200	Elliptical-1		

◆: Mount flush with PCB

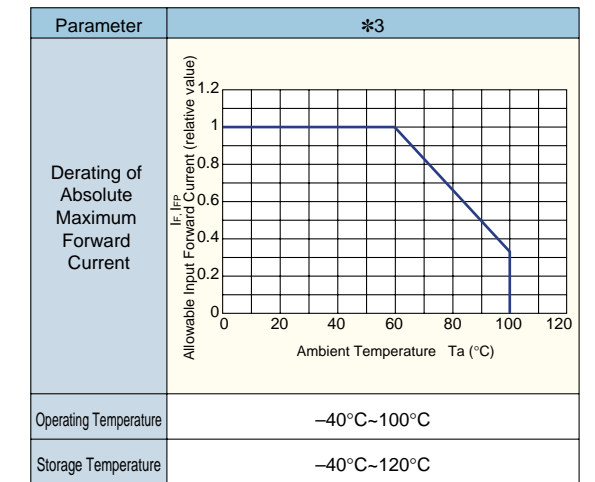
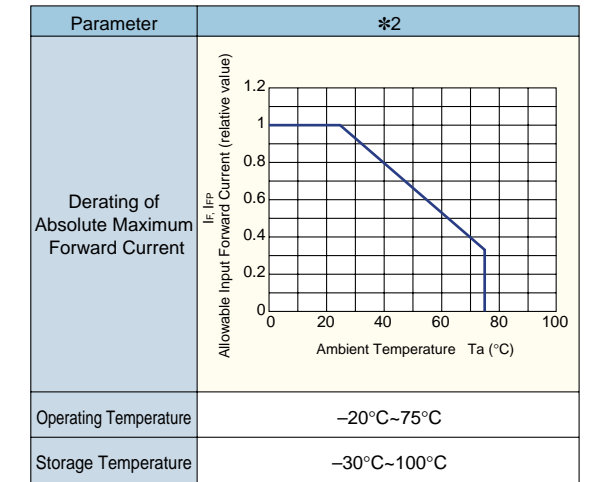
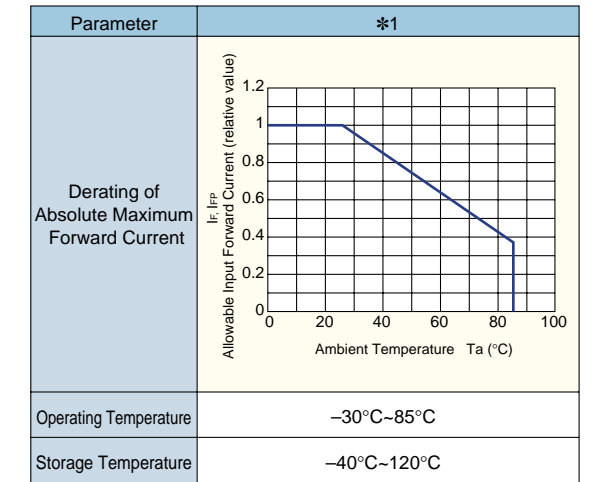

# 3 Product List for Lead Type

## 5. High-Brightness Green LED Lamps

@Ta = 25°C

Series Name	Package Size (mm)	Viewing Angle 2θ1/2	Intensity I <sub>v</sub> (mcd) @ I <sub>F</sub> = 20 mA		Product Number		Typical Emitting Wavelength		Lens Type	Absolute Maximum Ratings			Package Dimension Number	Typical Applications
			Min	Typ.	Open rank	Rank specified	λ <sub>d</sub> (nm)	λ <sub>p</sub> (nm)		Guaranteed Temperature	DC Forward Current I <sub>F</sub> (mA)	Pulse Forward Current I <sub>FP</sub> (mA)		
TL*U Series	ø5	5°	(1530)	4000	<b>NEW</b> TLGU23TP	—	571	574	Transparent	*3	30	120	ø5-9	Pilot lamps (narrow range)
			(476)	1600	<b>NEW</b> TLPGU23TP	—	558	562	Transparent	*3	30	120	ø5-9	
		30°	(85.0)	200	<b>NEW</b> TLGU18TP	—	571	574	Transparent	*3	30	120	ø5-12	Message board Backlighting
			(27.2)	90	<b>NEW</b> TLPGU18TP	—	558	562	Transparent	*3	30	120	ø5-12	
			(47.6)	180	<b>NEW</b> TLGU18CP	—	571	574	Green, transparent	*3	30	120	ø5-12	
			(27.2)	80	<b>NEW</b> TLPGU13CP	—	558	562	Green, transparent	*3	30	120	ø5-5	
		45°	(47.6)	120	<b>NEW</b> TLGU13CP	—	571	574	Green, transparent	*3	30	120	ø5-5	Message board Backlighting
			(27.2)	80	<b>NEW</b> TLPGU13CP	—	558	562	Green, transparent	*3	30	120	ø5-5	
		55°	(27.2)	70	<b>NEW</b> TLGU13DP	—	571	574	Green, diffusing	*3	30	120	ø5-5	Message board Backlighting
			(15.3)	35	<b>NEW</b> TLPGU13DP	—	558	562	Green, diffusing	*3	30	120	ø5-5	
	ø3	10°	(476)	1200	<b>NEW</b> TLGU50T	—	571	574	Transparent	*3	30	120	ø3-3	Pilot lamps
			(153)	450	<b>NEW</b> TLPGU50T	—	558	562	Transparent	*3	30	120	ø3-3	
		40°	(47.6)	170	<b>NEW</b> TLGU53T	—	571	574	Transparent	*3	30	120	ø3-4	Pilot lamps
			(27.2)	80	<b>NEW</b> TLPGU53T	—	558	562	Transparent	*3	30	120	ø3-4	
			(47.6)	150	<b>NEW</b> TLGU53C	—	571	574	Green, transparent	*3	30	120	ø3-4	
			(27.2)	70	<b>NEW</b> TLPGU53C	—	558	562	Green, transparent	*3	30	120	ø3-4	
		50°	(27.2)	80	<b>NEW</b> TLGU53D	—	571	574	Green, diffusing	*3	30	120	ø3-4	Pilot lamps (narrow range)
			(15.3)	40	<b>NEW</b> TLPGU53D	—	558	562	Green, diffusing	*3	30	120	ø3-4	
		80°	(27.2)	70	<b>NEW</b> TLGU62T	—	571	574	Transparent	*3	30	120	ø3-2	Pilot lamps (narrow range)
			(8.5)	25	<b>NEW</b> TLPGU62T	—	558	562	Transparent	*3	30	120	ø3-2	
Elliptical 5 X 5.8	30°/50°	(47.6)	180	<b>NEW</b> TLGU27C	—	571	574	Green, transparent	*3	30	120	Elliptical-1	Message board	

◆: Mount flush with PCB

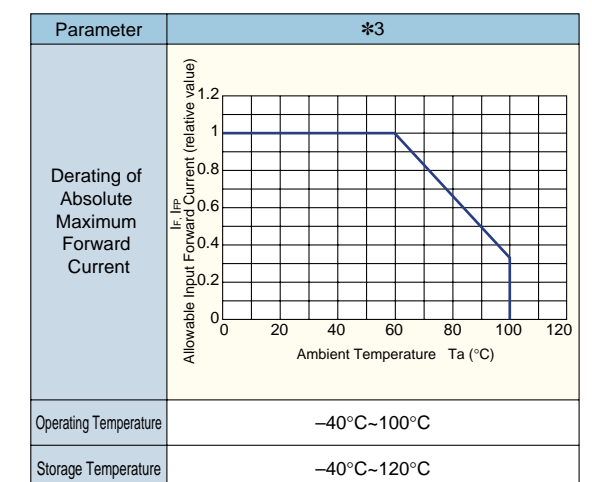
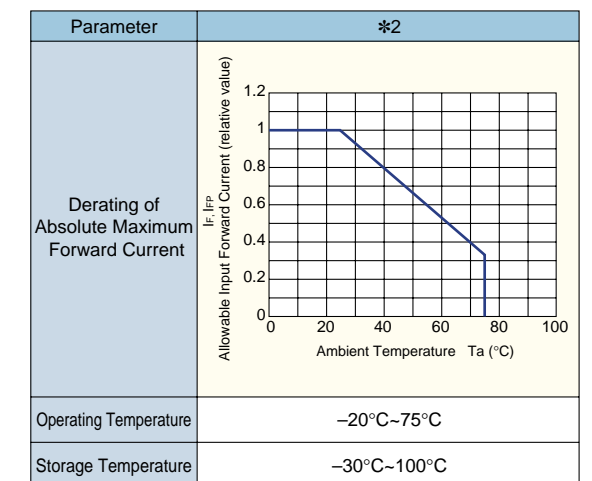
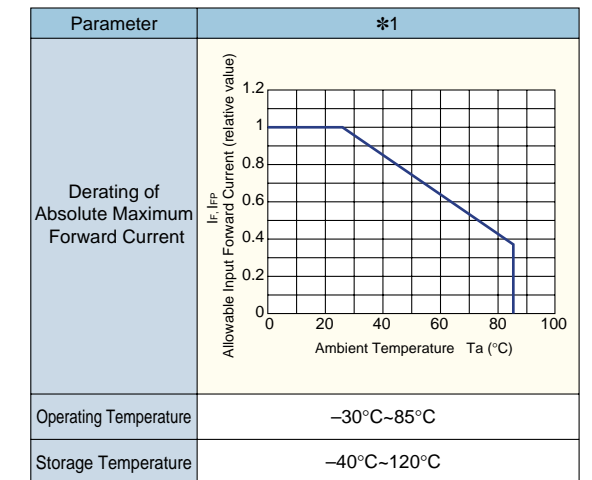

# 3 Product List for Lead Type

## 6. Package Dimensions

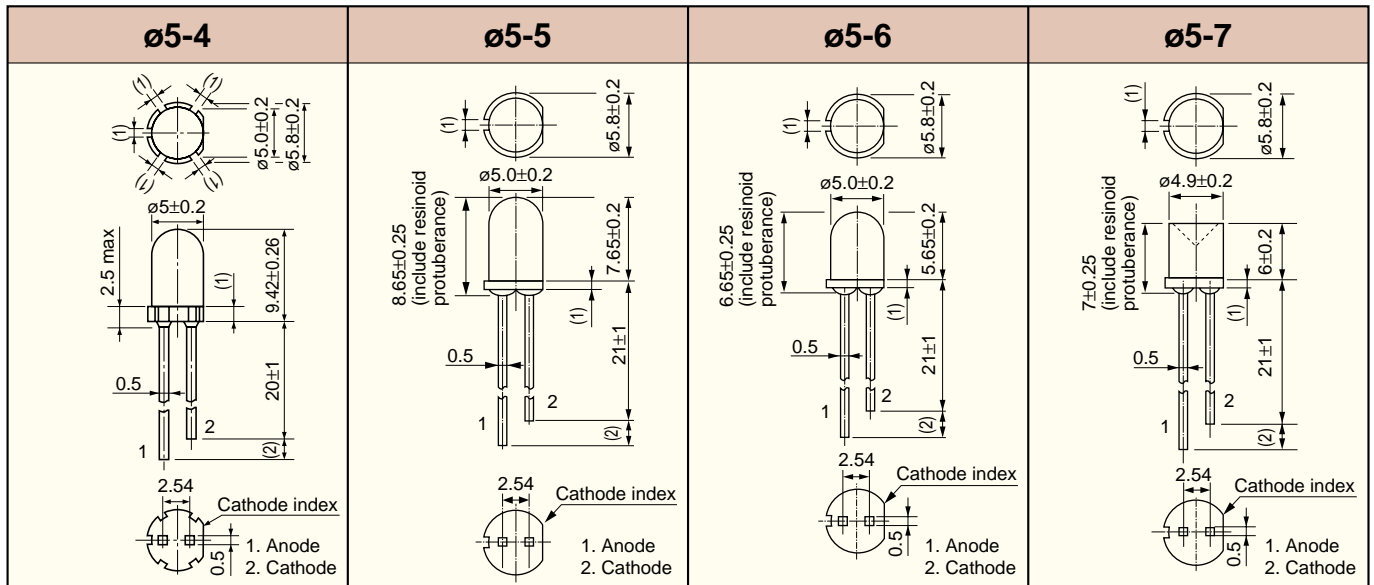
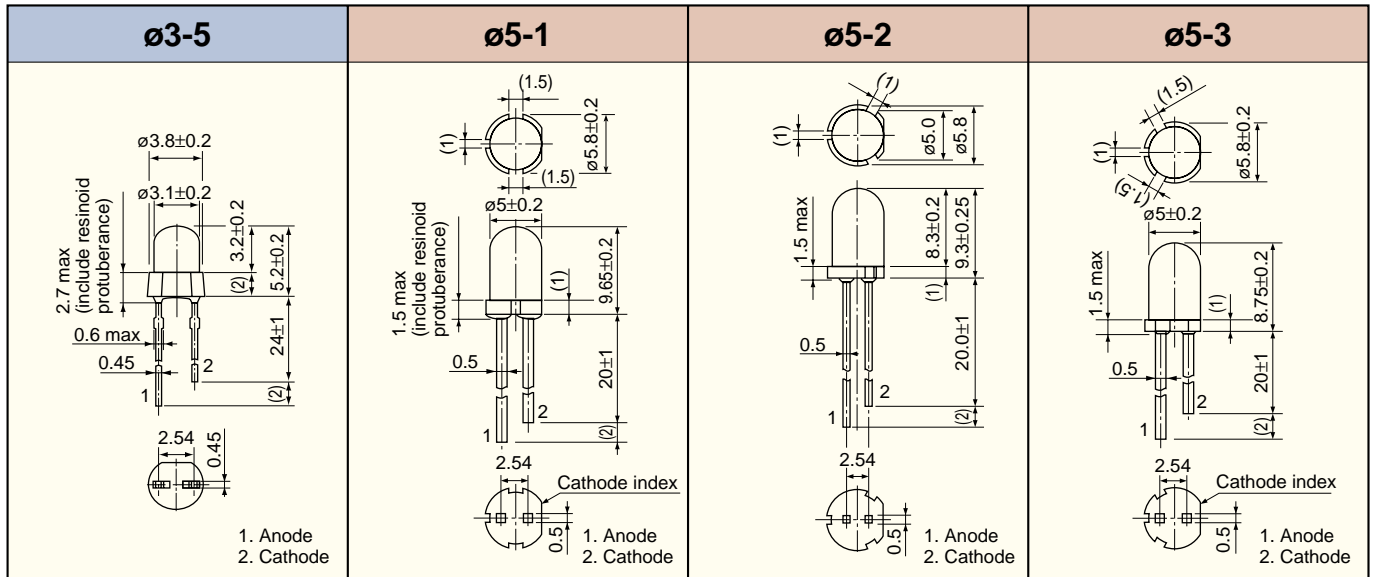
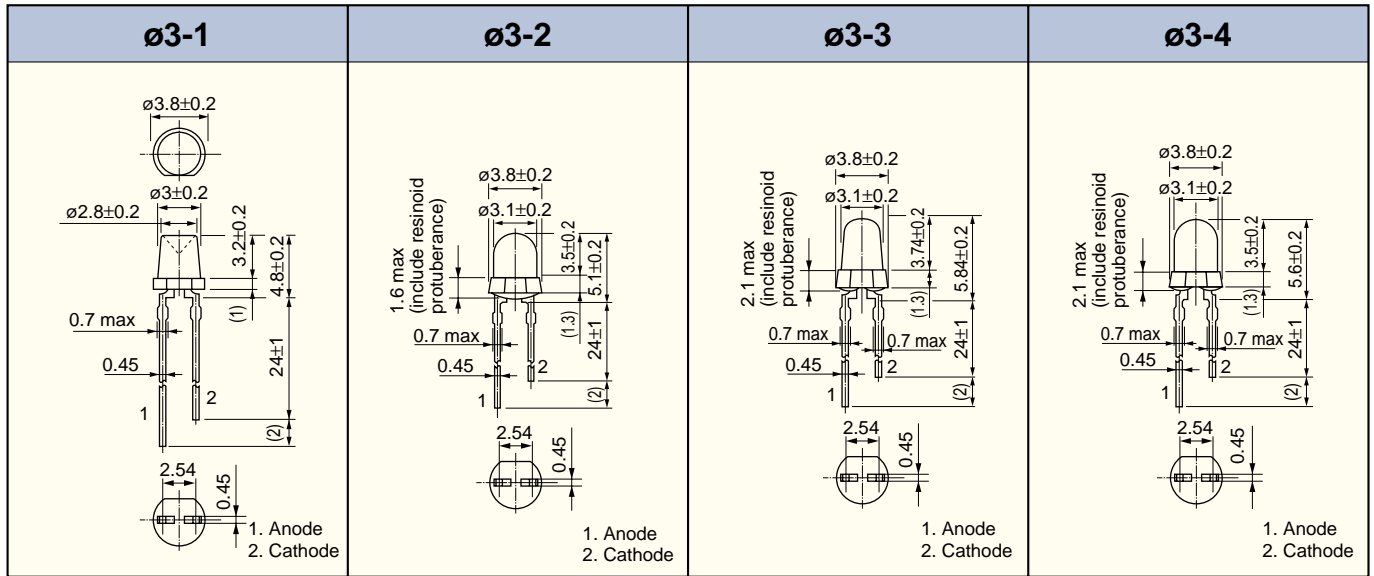

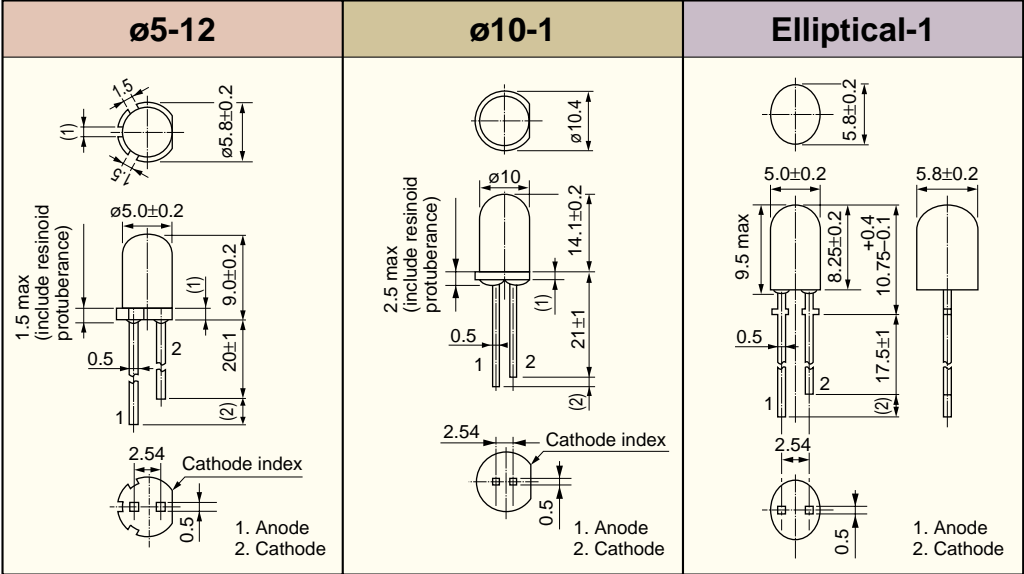
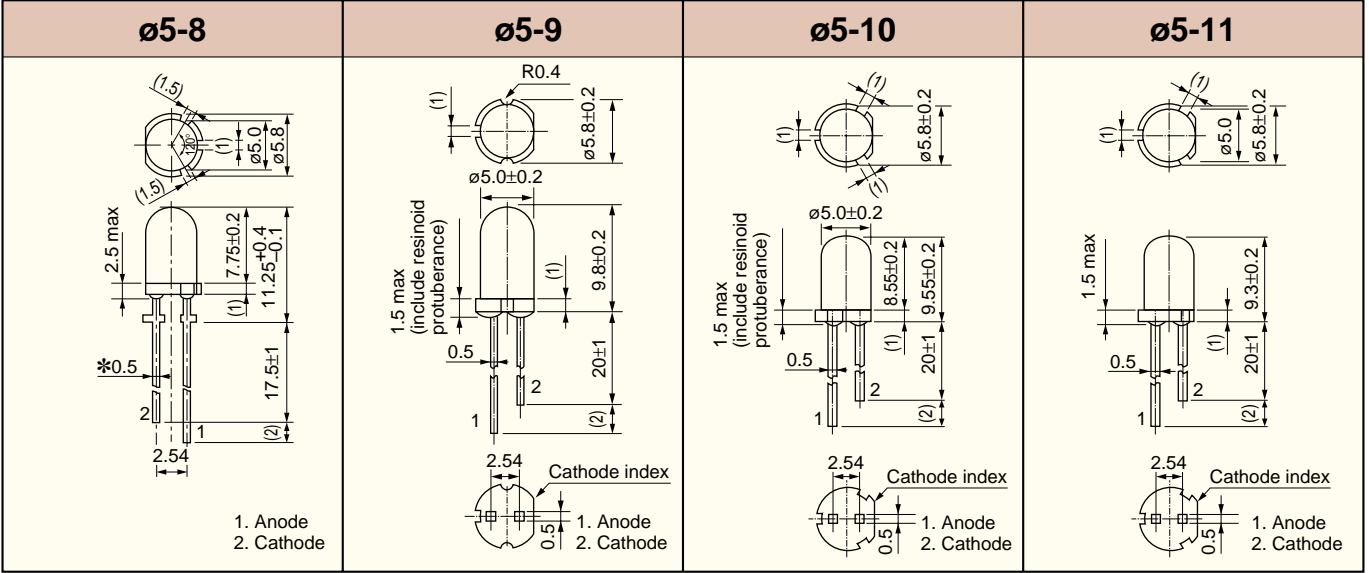

# 4 Product List for SMD Type

## 1. TL\*1008A (T04), TL\*1008A (T5)

### Features

- Package dimensions: 1.6 (L) x 0.8 (W) x 0.6 (H) mm
- Four-element (InGaAlP)
- High-brightness and low power consumption can be accomplished by a switch-over from general-purpose lamps.
- Taping with 4 mm (T04 specification) and 2 mm (T05 specification) pitch is standard. Achieves mounting efficiency.
- Product height of 0.6 mm is suitable for use as backlighting for thin equipment.

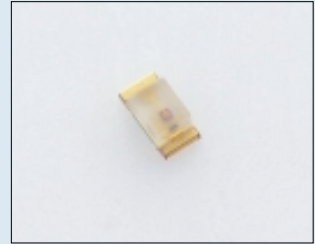

### Package Dimensions

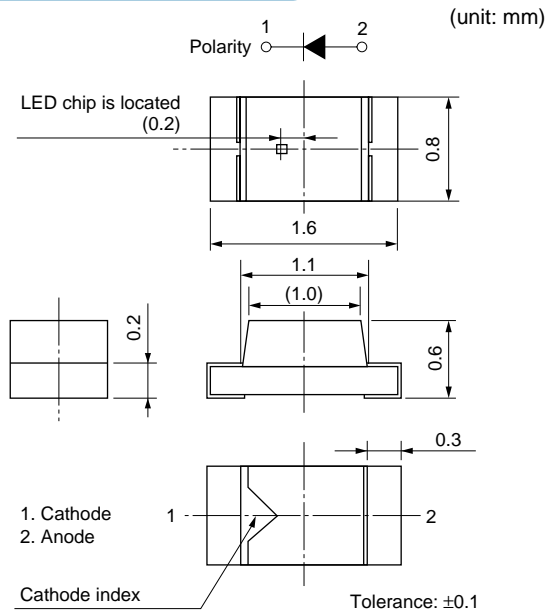

### Recommended Soldering Pad Dimensions

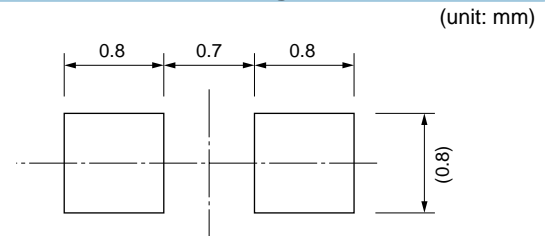

### Maximum Rating

(Ta = 25°C)

Characteristics	Symbol	Rating	Unit
DC Forward Current	I <sub>F</sub>	25	mA
DC Reverse Voltage	V <sub>R</sub>	4	V
Power Dissipation	P <sub>d</sub>	60~62.5 (Note 1)	mW
Operating Temperature	T <sub>opr</sub>	-40~85	°C
Storage Temperature	T <sub>stg</sub>	-40~100	°C

Note 1: please refer to each technical datasheet.

### Electrical and Optical Characteristics

Series Name	Emitted-Light Color	Product Number	Typical Luminous Intensity I <sub>v</sub> (mcd) @I <sub>F</sub> = 20 mA		Forward Voltage V <sub>F</sub> (V) @I <sub>F</sub> = 20 mA		Reverse Current I <sub>R</sub> (μA) @V <sub>R</sub> = 4 V	Typical Emission Wavelength (nm) @I <sub>F</sub> = 20 mA		
			Min	Typ.	Typ.	Max	Max	λ <sub>p</sub>	Δλ	λ <sub>d</sub>
TL*E Series	Red	TLRE1008A(T04)/(T05)	27.2	70	1.9	2.4	50	644	18	630
	Red	TLSE1008A(T04)/(T05)	47.6	140	1.9	2.4	50	623	17	613
	Orange	TLOE1008A(T04)/(T05)	47.6	180	2.0	2.4	50	612	15	605
	Yellow	TLYE1008A(T04)/(T05)	27.2	105	2.0	2.4	50	590	13	587
	Green	TLGE1008A(T04)/(T05)	27.2	70	2.0	2.4	50	574	11	571
	Pure green	TLPGE1008A(T04)/(T05)	4.76	18	2.1	2.4	50	562	11	558
TL*U Series	Red	TLSU1008A(T04)/(T05)	27.2	60	2.0	2.4	50	636	17	623
	Orange	TLOU1008A(T04)/(T05)	27.2	78	2.1	2.5	50	612	15	605
	Amber	TLAU1008A(T04)/(T05)	8.5	30	2.1	2.5	50	596	13	592
	Yellow	TLYU1008A(T04)/(T05)	8.5	30	2.1	2.5	50	590	13	587
	Green	TLGU1008A(T04)/(T05)	8.5	30	2.1	2.5	50	574	11	571
	Pure green	TLPGU1008A(T04)/(T05)	1.53	6	2.1	2.5	50	562	11	558

# Characteristics Diagram

**Iv – If**

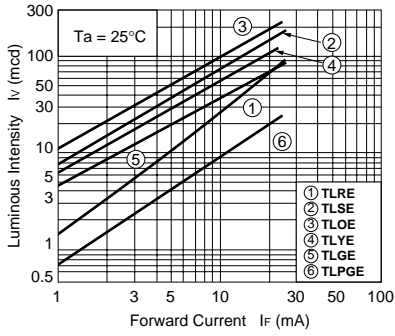

**Iv – If**

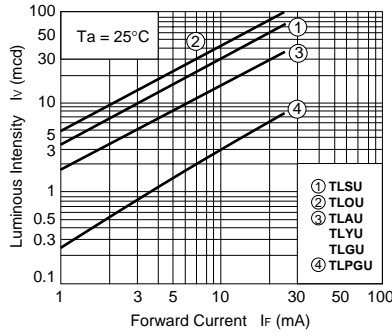

**If – Vf**

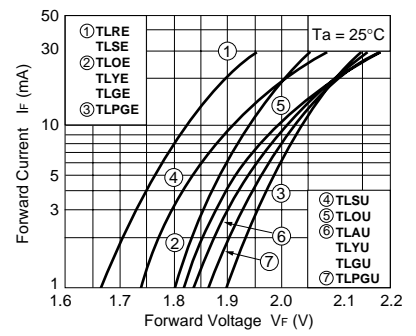

**Iv – Tc**

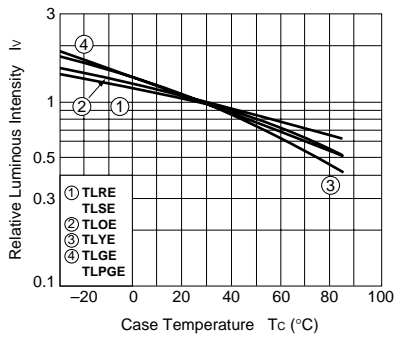

**Iv – Tc**

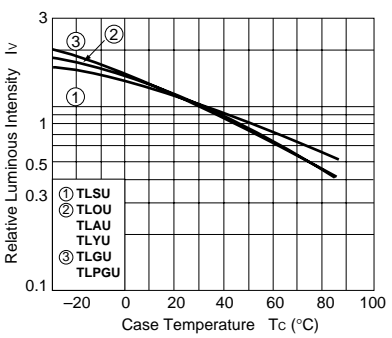

**Allowable forward pulse current characteristics**

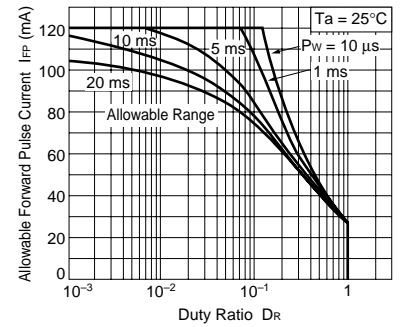

**If – Ta**

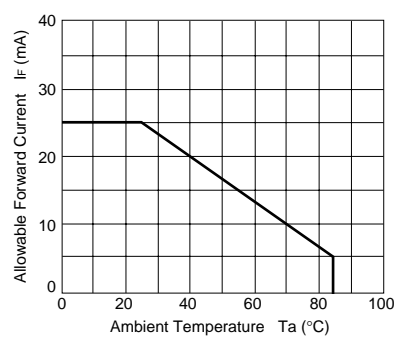

**Radiation pattern**

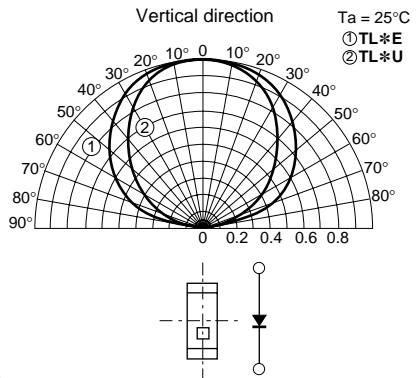
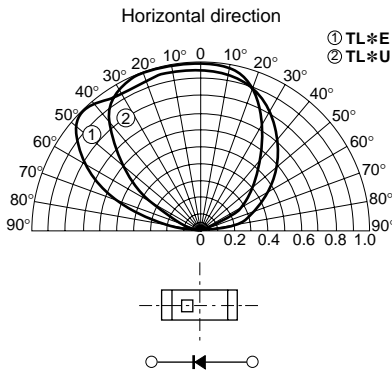

## Tape Specifications

Tape Packing Type	Tape Type Suffix	Pitches	Packing		Quantity/Reel
			Package dimensions (mm)	Appearance	
Embossed Tape Packing	T04	4 mm			4000/reel
Embossed Tape Packing	T05	2 mm			8000/reel

# 4 Product List for SMD Type

## 2. TL\*1002A (T02)

### Features

- Package dimensions: 2.0 (L) x 1.25 (W) x 1.1 (H) mm
- Four-element (InGaAlP)
- High-brightness and low power consumption can be accomplished by a switchover from general-purpose lamps.
- Product height of 1.1 mm is suitable for use as backlighting for thin equipment.



### Package Dimensions

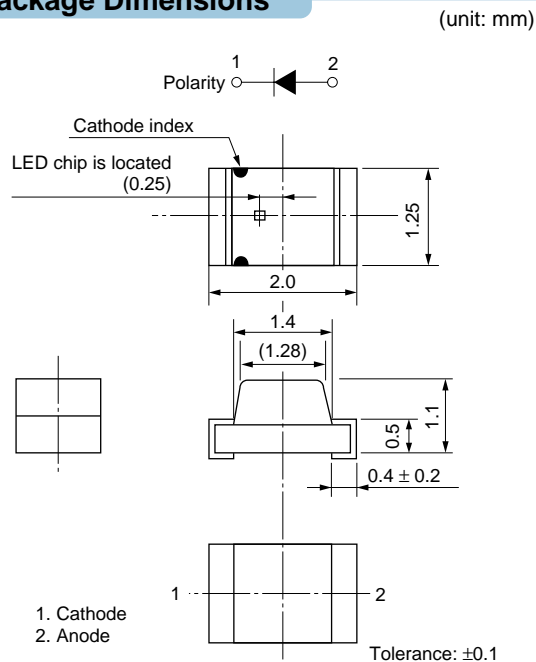

### Recommended Soldering Pad Dimensions

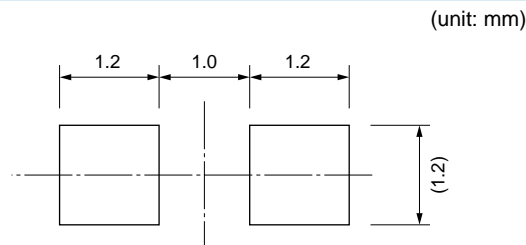

### Maximum Rating

(Ta = 25°C)

Characteristics	Symbol	Rating	Unit
DC Forward Current	I <sub>F</sub>	25	mA
DC Reverse Voltage	V <sub>R</sub>	4	V
Power Dissipation	P <sub>D</sub>	60~62.5 (Note 1)	mW
Operating Temperature	T <sub>opr</sub>	-40~85	°C
Storage Temperature	T <sub>stg</sub>	-40~100	°C

Note 1: please refer to each technical datasheet.

### Electrical and Optical Characteristics

Series Name	Emitted-Light Color	Product Number	Typical Luminous Intensity I <sub>v</sub> (mcd) @ I <sub>F</sub> = 20 mA		Forward Voltage V <sub>F</sub> (V) @ I <sub>F</sub> = 20 mA		Reverse Current I <sub>R</sub> (μA) @ V <sub>R</sub> = 4 V	Typical Emission Wavelength (nm) @ I <sub>F</sub> = 20 mA		
			Min	Typ.	Typ.	Max		λ <sub>p</sub>	Δλ	λ <sub>d</sub>
TL*E Series	Red	TLRE1002A(T02)	27.2	70	1.9	2.4	50	644	18	630
	Red	TLSE1002A(T02)	47.6	140	1.9	2.4	50	623	17	613
	Orange	TLOE1002A(T02)	47.6	180	2.0	2.4	50	612	15	605
	Yellow	TLYE1002A(T02)	27.2	105	2.0	2.4	50	590	13	587
	Green	TLGE1002A(T02)	27.2	70	2.0	2.4	50	574	11	571
	Pure green	TLPGE1002A(T02)	4.76	18	2.1	2.4	50	562	11	558
TL*U Series	Red	TLRU1002A(T02)	15.3	45	2.0	2.4	50	644	18	630
	Red	TLSU1002A(T02)	27.2	60	2.0	2.4	50	636	17	623
	Orange	TLOU1002A(T02)	27.2	78	2.1	2.5	50	612	15	605
	Amber	TLAU1002A(T02)	8.5	30	2.1	2.5	50	596	13	592
	Yellow	TYU1002A(T02)	8.5	30	2.1	2.5	50	590	13	587
	Green	TLGU1002A(T02)	8.5	30	2.1	2.5	50	574	11	571
	Pure green	TLPGU1002A(T02)	1.53	6	2.1	2.5	50	562	11	558

# Characteristics Diagram

**Iv – If**

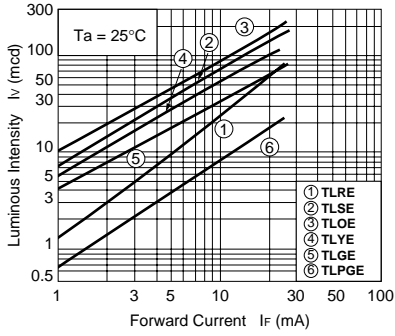

**Iv – If**

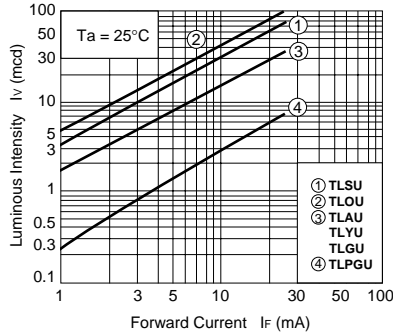

**If – Vf**

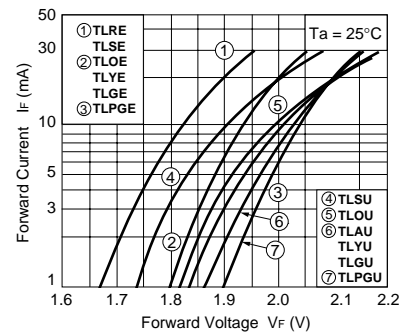

**Iv – Tc**

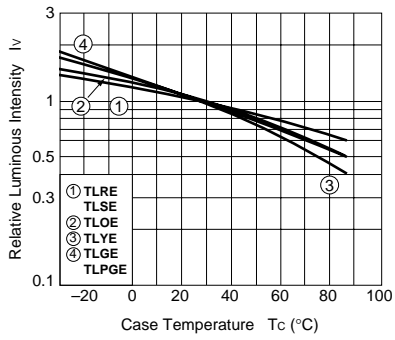

**Iv – Tc**

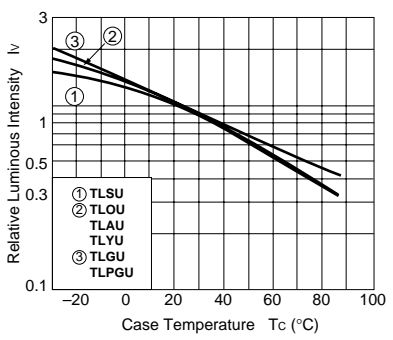

**Allowable forward pulse current characteristics**

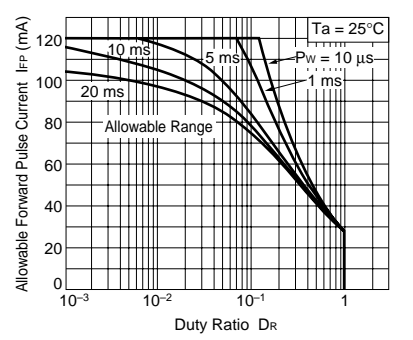

**If – Ta**

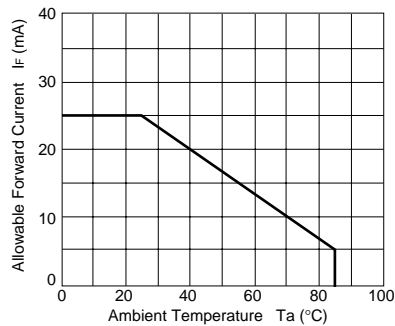

**Radiation pattern**

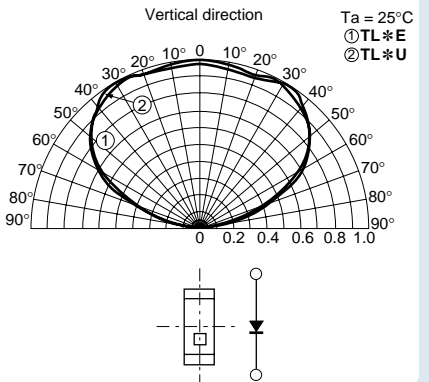
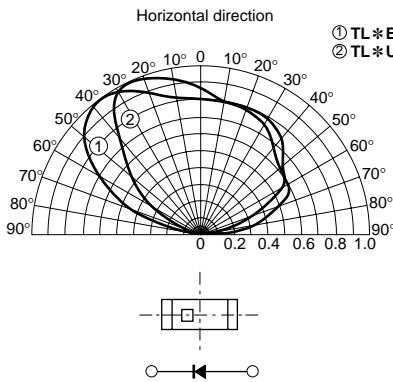

## Tape Specifications

Tape Packing Type	Tape Type Suffix	Pitches	Packing		Quantity/Reel
			Package dimensions (mm)	Appearance	
Embossed Tape Packing	T02	4 mm			3000/reel



# 4 Product List for SMD Type

## 3. TL\*E1005B (T03), TL\*U1005A (T03)

### Features

- Package dimensions: 3.2 (L) x 2.4 (W) x 2.4 (H) mm
- Unique  $\phi 2$  mm lens top structure substantially improves light extraction.
- Designed for miniaturization and slimming while maintaining high luminance
- Optical axis precision is substantially improved over lead-frame structure LEDs.  
Designed to reduce nonuniformity in the display

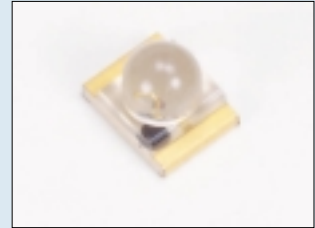

### Package Dimensions

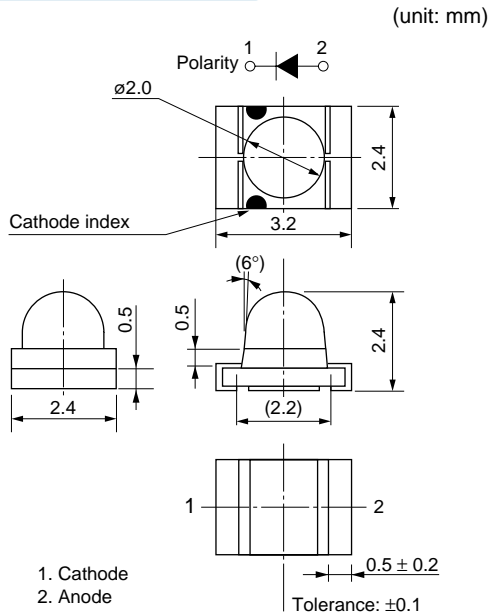

### Recommended Soldering Pad Dimensions

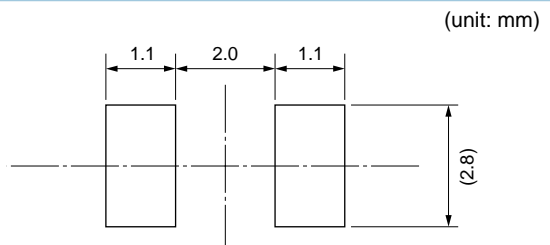

### Maximum Rating

(Ta = 25°C)

Characteristics	Symbol	Rating	Unit
DC Forward Current	I <sub>F</sub>	25	mA
DC Reverse Voltage	V <sub>R</sub>	4	V
Power Dissipation	P <sub>D</sub>	60~62.5 (Note 1)	mW
Operating Temperature	T <sub>opr</sub>	TL*U	-25~80
		TL*E	-40~85
Storage Temperature	T <sub>stg</sub>	TL*U	-30~85
		TL*E	-40~100

Note 1: please refer to each technical datasheet.

### Electrical and Optical Characteristics

Series Name	Emitted-Light Color	Product Number	Typical Luminous Intensity I <sub>v</sub> (mcd) @ I <sub>F</sub> = 20 mA		Forward Voltage V <sub>F</sub> (V) @ I <sub>F</sub> = 20 mA		Reverse Current I <sub>R</sub> (μA) @ V <sub>R</sub> = 4 V	Typical Emission Wavelength (nm) @ I <sub>F</sub> = 20 mA		
			Min	Typ.	Typ.	Max		λ <sub>p</sub>	Δλ	λ <sub>d</sub>
TL*E Series	Red	TLRE1005B(T03)	153	450	1.9	2.4	50	644	18	630
	Red	TLSE1005B(T03)	272	1000	1.9	2.4	50	623	17	613
	Orange	TLOE1005B(T03)	476	1500	2.0	2.4	50	612	15	605
	Yellow	TLYE1005B(T03)	272	850	2.0	2.4	50	590	13	587
	Green	TLGE1005B(T03)	153	350	2.0	2.4	50	574	11	571
	Pure green	TLPGE1005B(T03)	47.6	130	2.1	2.4	50	562	11	558
TL*U Series	Red	TLSU1005A(T03)	153	450	2.0	2.4	50	636	17	623
	Orange	TLOU1005A(T03)	153	450	2.0	2.4	50	612	15	605
	Yellow	TLYU1005A(T03)	47.6	140	2.1	2.5	50	590	13	587

### Automatic Mounting: Recommended Conditions

Absorption Head Diameter	ø1.2 mm
--------------------------	---------

Please ask the mounting equipment maker for the ideal automatic mounting conditions.

## Characteristics Diagram

$I_v - I_f$

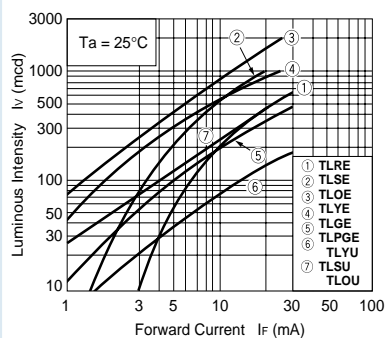

$I_f - V_f$

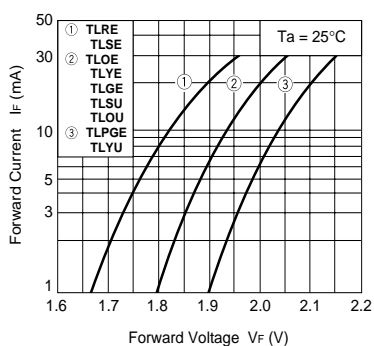

$I_v - T_c$

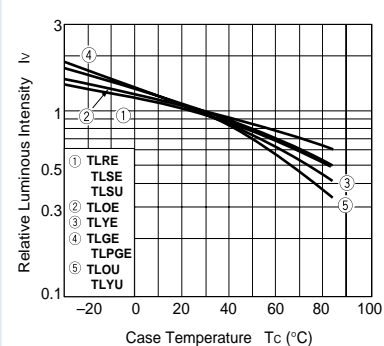

Allowable forward pulse current characteristics

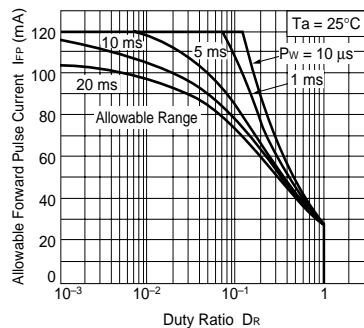

$I_f - T_a$

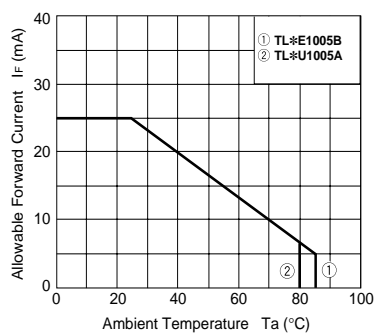

Radiation pattern

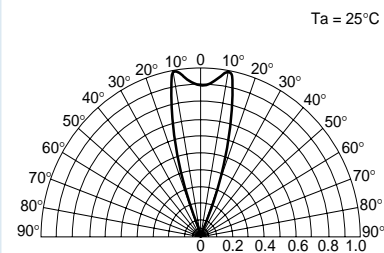

## Tape Specifications

Tape Packing Type	Tape Type Suffix	Pitches	Packing		Quantity/Reel
			Package dimensions (mm)	Appearance	
Embossed Tape Packing	T03	4 mm			1000/reel

# 4 Product List for SMD Type

## 4. TL\*1100 (T09), TL\*E1100 (T11), S4F42\* (T09)

### Features

- Package dimensions: 3.2 (L) x 2.8 (W) x 1.9 (H) mm
- Four-element (InGaAlP)
- High-heat resistance extends the operating temperature range.  
Topr = -40~100°C



### Package Dimensions

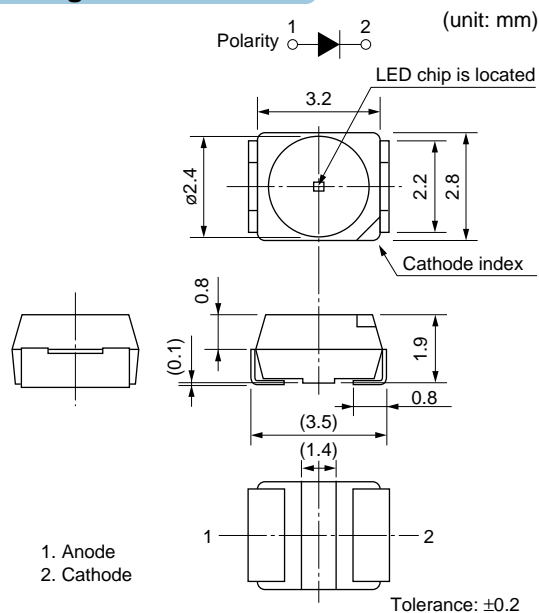

### Recommended Soldering Pad Dimensions

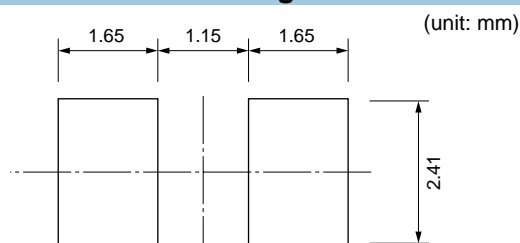

### Maximum Rating

(Ta = 25°C)

Characteristics	Symbol	Rating	Unit
DC Forward Current	IF	30/50 (Note 1)	mA
DC Reverse Voltage	VR	4	V
Power Dissipation	PD	72~140 (Note 1)	mW
Operating Temperature	Topr	-40~100	°C
Storage Temperature	Tstg	-40~100	°C

Note 1: please refer to each technical datasheet.

### Electrical and Optical Characteristics

Series Name	Emitted-Light Color	Product Number	Typical Luminous Intensity Iv (mcd) @IF = 20 mA		Forward Voltage VF (V) @IF = 20 mA		Reverse Current IR (μA) @VR = 4 V	Typical Emission Wavelength (nm) @IF = 20 mA		
			Min	Typ.	Typ.	Max		Max	λp	Δλ
TL*H Series	Red	TLRH1100(T09)	47.6	130	1.9	2.5	50	644	18	630
	Red	TLSH1100(T09)	85	240	2.1	2.5	50	623	15	613
	Orange	TLOH1100(T09)	85	260	2.1	2.5	50	612	15	605
	Yellow	TLYH1100(T09)	85	190	2.1	2.5	50	590	13	587
TL*E Series	Red	TLRE1100(T11)	47.6	100	1.9	2.4	50	644	18	630
	Red	TLSE1100(T11)	47.6	180	1.9	2.4	50	623	15	613
	Orange	TLOE1100(T11)	47.6	180	2.0	2.4	50	612	15	605
	Yellow	TLYE1100(T11)	47.6	150	2.0	2.4	50	590	13	587
	Green	TLGE1100(T11)	47.6	100	2.0	2.4	50	574	11	571
	Pure green	TLPGE1100(T11)	8.5	25	2.1	2.4	50	562	11	558
TL*U Series	Red	TLSU1100(T09)	27.2	80	2.0	2.4	50	636	17	623
	Orange	TLOU1100(T09)	47.6	100	2.0	2.4	50	612	15	605
	Yellow	TLYU1100(T09)	15.3	50	2.1	2.5	50	590	13	587
	Green	TLGU1100(T09)	15.3	45	2.3	2.8	50	574	11	571
	Pure green	TLPGU1100(T09)	4.76	12	2.3	2.8	50	562	11	558
Others	Green	S4F42Q1(T09)	47.6	110	2.27	2.8	50	574	11	571
	Pure green	S4F42Z1(T09)	8.5	25	2.27	2.8	50	562	11	558

## Characteristics Diagram

**I<sub>v</sub> – I<sub>f</sub>**

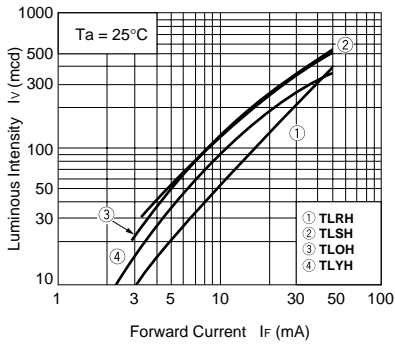

**I<sub>v</sub> – I<sub>f</sub>**

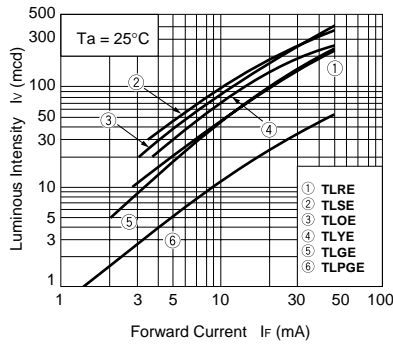

**I<sub>v</sub> – I<sub>f</sub>**

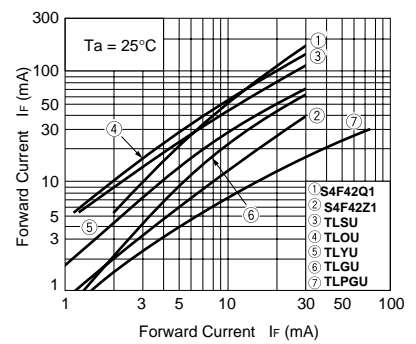

**I<sub>f</sub> – V<sub>f</sub>**

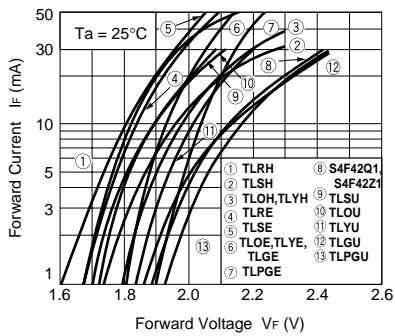

**I<sub>v</sub> – T<sub>c</sub>**

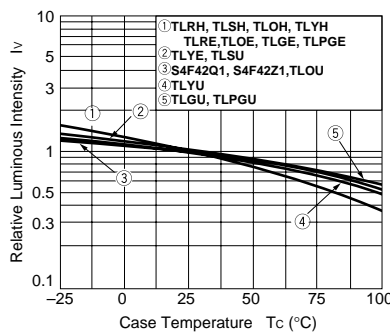

**Allowable forward pulse current characteristics**

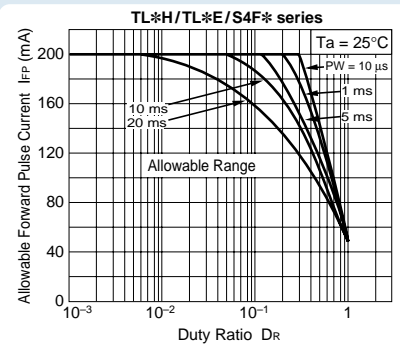

**Allowable forward pulse current characteristics**

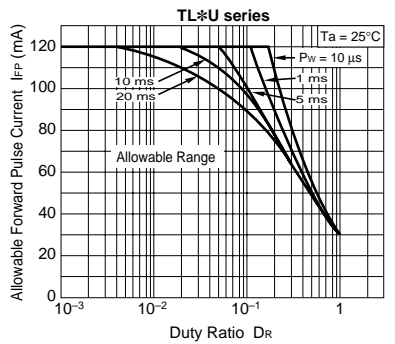

**I<sub>f</sub> – T<sub>a</sub>**

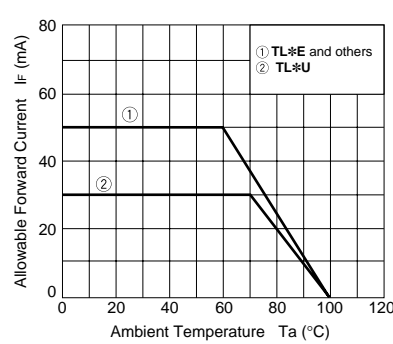

**Radiation pattern**

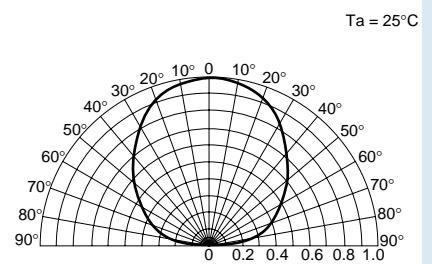

## Tape Specifications

Tape Packing Type	Tape Type Suffix	Pitches	Packing		Quantity/Reel
			Package dimensions (mm)	Appearance	
Embossed Tape Packing	T09	8 mm			1000/reel
Embossed Tape Packing	T11	4 mm			2000/reel

# 4 Product List for SMD Type

## 5. TL\*1102 (T10), S4F43\* (T10)

### Features

- Package dimensions: 3.2 (L) x 2.8 (W) x 3.4 (H) mm
- 4-element (InGaAlP), H Series / U Series
- High-heat resistance extends the operating temperature range.  
Topr = -40~100°C

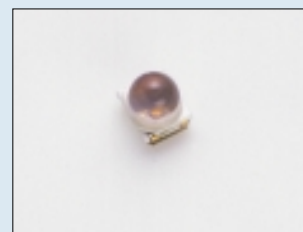

### Package Dimensions

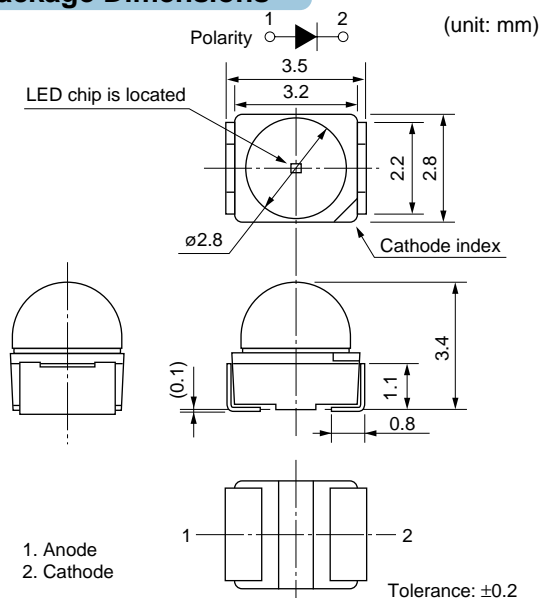

### Recommended Soldering Pad Dimensions

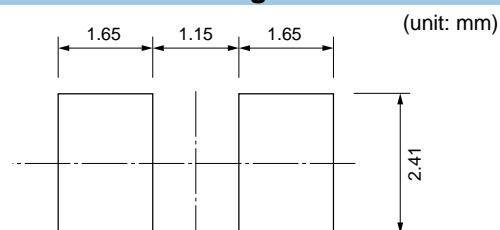

### Maximum Rating

(Ta = 25°C)

Characteristics	Symbol	Rating	Unit
DC Forward Current	IF	30/50 (Note 1)	mA
DC Reverse Voltage	VR	4	V
Power Dissipation	PD	72~140 (Note 1)	mW
Operating Temperature	Topr	-40~100	°C
Storage Temperature	Tstg	-40~100	°C

Note1: please refer to each technical datasheet.

### Electrical and Optical Characteristics

Series Name	Emitted-Light Color	Product Number	Typical Luminous Intensity I <sub>v</sub> (mcd) @I <sub>F</sub> = 20 mA		Forward Voltage V <sub>F</sub> (V) @I <sub>F</sub> = 20 mA		Reverse Current I <sub>R</sub> (μA) @V <sub>R</sub> = 4 V	Typical Emission Wavelength (nm) @I <sub>F</sub> = 20 mA		
			Min	Typ.	Typ.	Max	Max	λ <sub>p</sub>	Δλ	λ <sub>d</sub>
TL*H Series	Red	TLRH1102(T10)	85	320	1.9	2.5	50	644	18	630
	Red	TLSH1102(T10)	153	600	2.1	2.5	50	623	15	613
	Orange	TLOH1102(T10)	272	650	2.1	2.5	50	612	15	605
	Yellow	TLYH1102(T10)	153	480	2.1	2.5	50	590	13	587
TL*E Series	Red	TLRE1102(T10)	85	320	1.9	2.4	50	644	18	630
	Red	TLSE1102(T10)	272	600	1.9	2.4	50	623	17	613
	Orange	TLOE1102(T10)	272	650	2.0	2.4	50	612	15	605
	Yellow	TLYE1102(T10)	153	480	2.0	2.4	50	590	13	587
	Green	TLGE1102(T10)	85	300	2.0	2.4	50	574	11	571
	Pure green	TLPGE1102(T10)	27.2	75	2.1	2.4	50	562	11	558
TL*U Series	Red	TLSU1102(T10)	85	200	2.0	2.4	50	636	17	623
	Orange	TLOU1102(T10)	85	250	2.0	2.4	50	612	15	605
	Yellow	TLYU1102(T10)	47.6	130	2.1	2.5	50	590	13	587
	Green	TLGU1102(T10)	47.6	120	2.3	2.8	50	574	11	571
	Pure green	TLPGU1102(T10)	8.5	30	2.3	2.8	50	562	11	558
Others	Green	S4F43Q1(T10)	85	250	2.27	2.8	50	574	11	571
	Pure green	S4F43Z1(T10)	27.2	60	2.27	2.8	50	562	11	558

## Characteristics Diagram

$I_v - I_f$

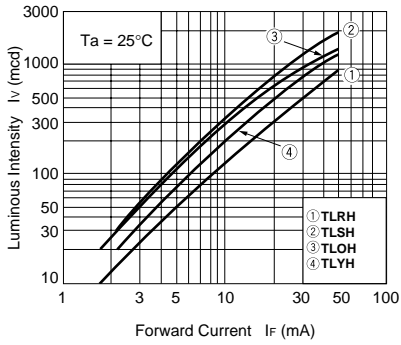

$I_v - I_f$

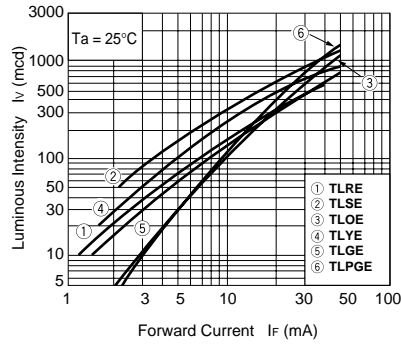

$I_v - I_f$

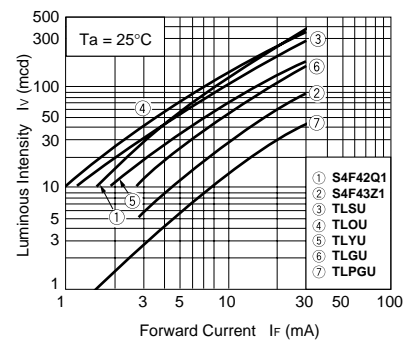

$I_f - V_f$

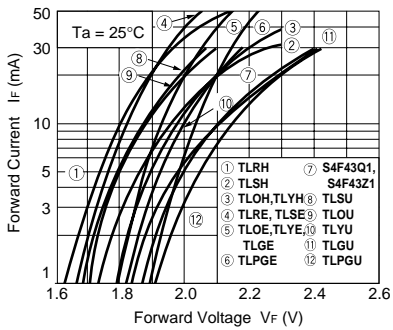

$I_v - T_c$

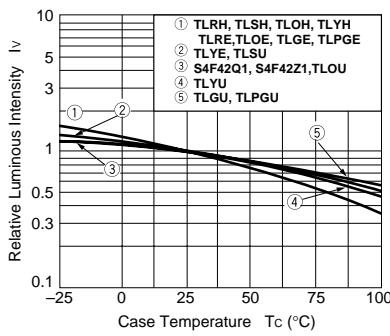

Allowable forward pulse current characteristics

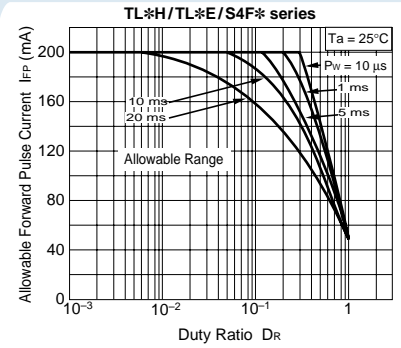

Allowable forward pulse current characteristics

$I_f - T_a$

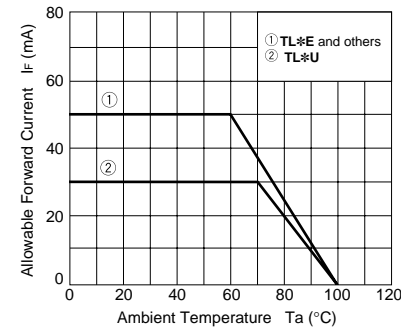

Radiation pattern

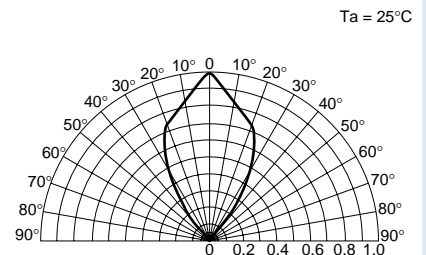

TL\*U series

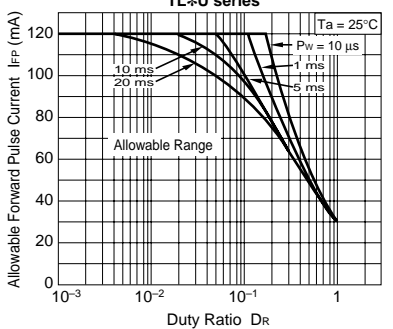

## Tape Specifications

Tape Packing Type	Tape Type Suffix	Pitches	Packing		Quantity/Reel
			Package dimensions (mm)	Appearance	
Embossed Tape Packing	T10	8 mm			500/reel

# 5 Packing Specifications

## 1. Lead Type

### 1-1 Tape packing

These tape specifications apply to 2-lead LED lamps with diameters of 3.1 mm and 5 mm.

These LED lamps have 2.54 mm and 5 mm lead pitches respectively, and can be mounted on a circuit board using an auto-insertion machine. Packing can either be in an ammo pack or a reel pack as desired.

#### Product number format

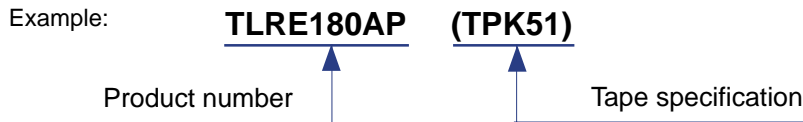

#### Tape specifications

Tapes are classified by lead polarity, packing style and distance from the device base to the tape feedhole centerline, as shown below.

Tape Specifications			Tape Forms
Reel pack		Ammo pack	
Anode lead-out	Cathode lead-out		
TPK1	TPKR1	TPK51	A
TPK3	TPKR3	TPK53	B
TPK5	TPKR5	TPK55	C
TPJ1	TPJR1	TPJ51	D
TPJ2	TPJR2	TPJ52	E
TPJ3	TPJR3	TPJ53	F
TPJ6	TPJR6	TPJ56	G

Unit: mm

#### Tape dimensions

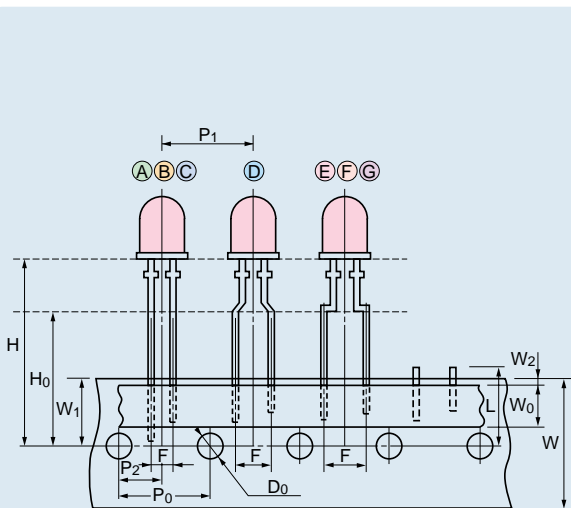

	A	B	C	D	E	F	G
H	23.35 ± 1.0	18.55 ± 1.0	17.0 ± 1.0	23.35 ± 1.0	20.5 ± 1.0	22.5 ± 1.0	23.35 ± 1.0
H <sub>0</sub>	—			16.0 ± 0.5			
W	18.0 <sup>+1</sup> / <sub>-0.5</sub>						
W <sub>0</sub>	6.0 ± 0.3 or 13.0 ± 0.3						
W <sub>1</sub>	9.0 <sup>+0.75</sup> / <sub>-0.5</sub>						
W <sub>2</sub>	≤ 0.5						
P <sub>0</sub>	12.7						
P <sub>1</sub>	12.7 ± 1 (product pitch)						
P <sub>2</sub>	6.35 ± 1.3						
F	2.54 <sup>+0.8</sup> / <sub>-0.2</sub>			5.00 <sup>+0.8</sup> / <sub>-0.2</sub>			
L	11.0 max						
D <sub>0</sub>	ø4.0 ± 0.2						

## Reel pack

### ■ Reel dimensions and winding

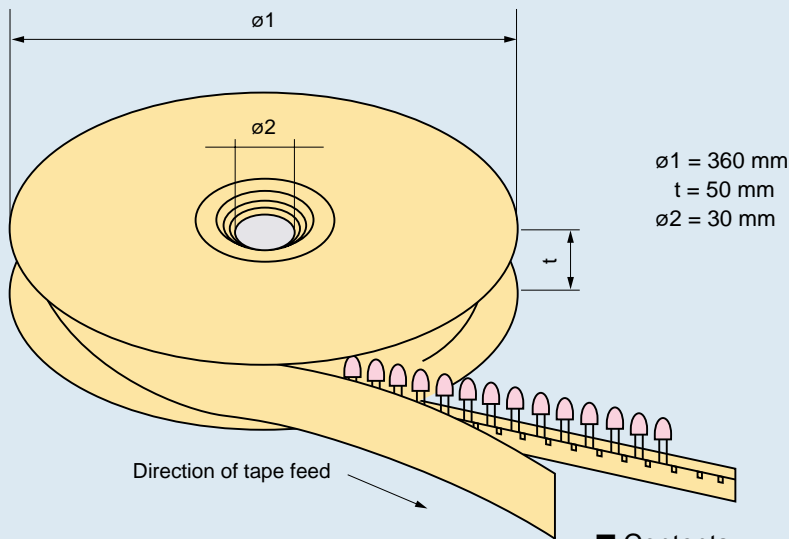

$\varnothing 1 = 360 \text{ mm}$   
 $t = 50 \text{ mm}$   
 $\varnothing 2 = 30 \text{ mm}$

### ■ Contents

LED type	Quantity per Reel
$\varnothing 3$ Series	2,000
$\varnothing 5$ Series	1,000

## Ammo pack

- (1) Taped devices are packed by alternately folding the tape every 25 devices.
- (2) Four or more devices are removed from the beginning and end of the tape.

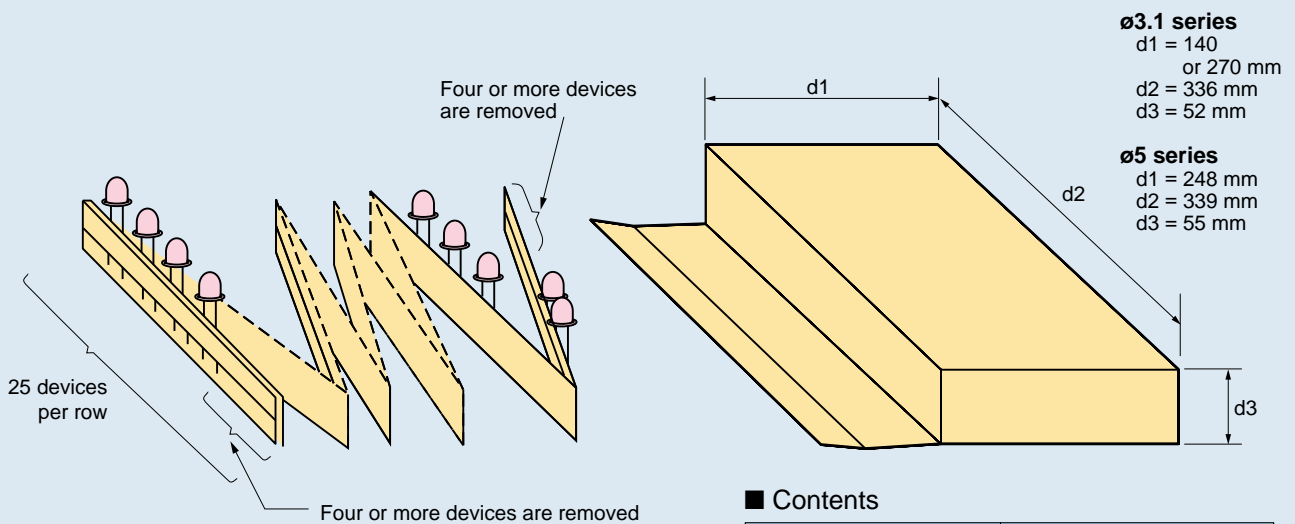

**$\varnothing 3.1$  series**  
 $d1 = 140$   
 or  $270 \text{ mm}$   
 $d2 = 336 \text{ mm}$   
 $d3 = 52 \text{ mm}$

**$\varnothing 5$  series**  
 $d1 = 248 \text{ mm}$   
 $d2 = 339 \text{ mm}$   
 $d3 = 55 \text{ mm}$

### ■ Contents

LED type	Quantity per Reel
$\varnothing 3$ Series	2,000 or 4,000
$\varnothing 5$ Series	1,000 or 2,000



# 5 Packing Specifications

## 1-2 Packing (Devices are loose in bags.)

### Packing for $\varnothing 5$ -mm type

Minimum number of LED lamps: 500 per plastic bag

#### ● Large box (standard)

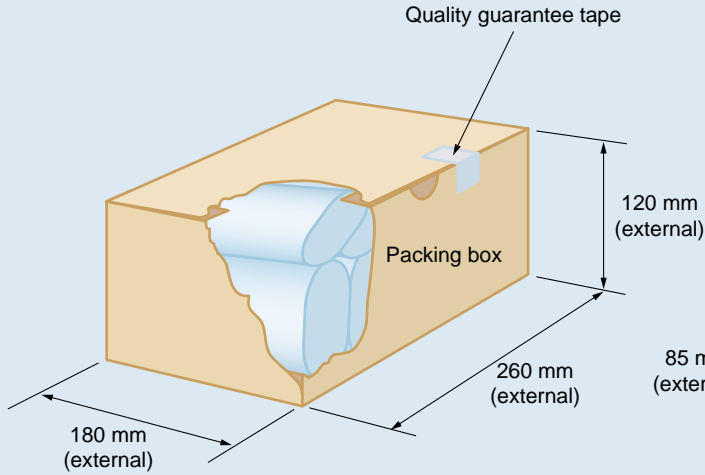

10 bags with 5,000 LED lamps

#### ● Small box

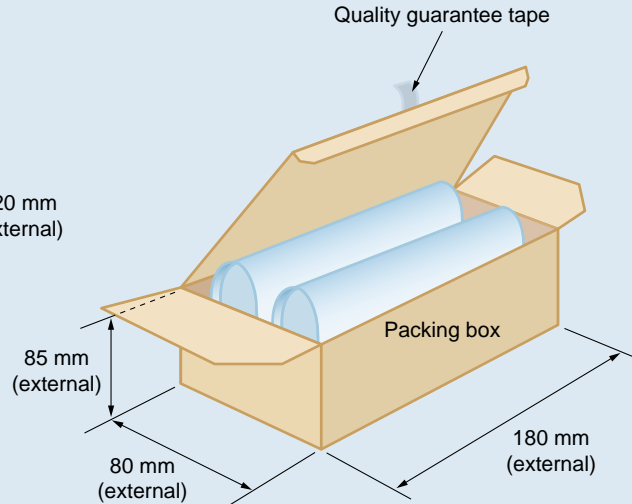

2 bags with 1,000 LED lamps

### Packing for $\varnothing 3$ -mm type

Minimum number of LED lamps: 500 per plastic bag

#### ● Large box (standard)

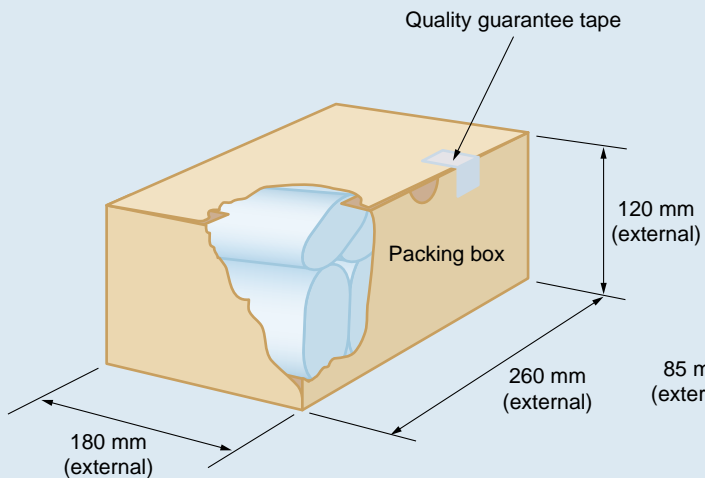

20 bags with 10,000 LED lamps

#### ● Small box

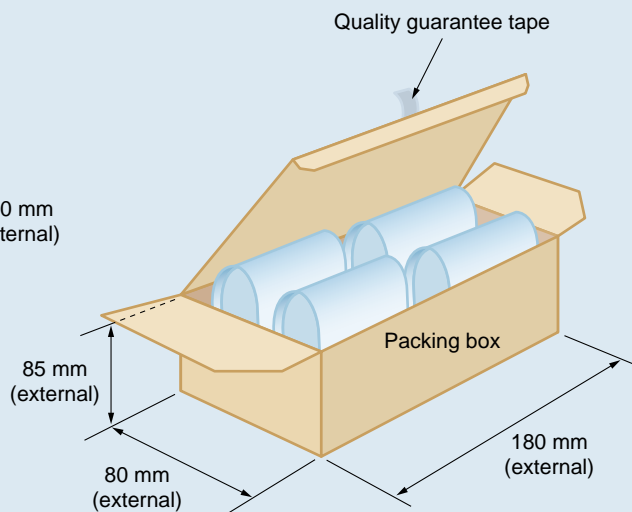

4 bags with 2,000 LED lamps

## 2. SMD Type

### Tape dimensions

(Unit: mm)

**T02**

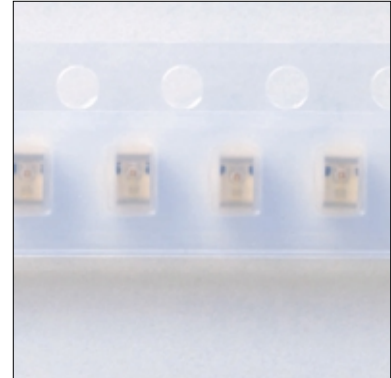
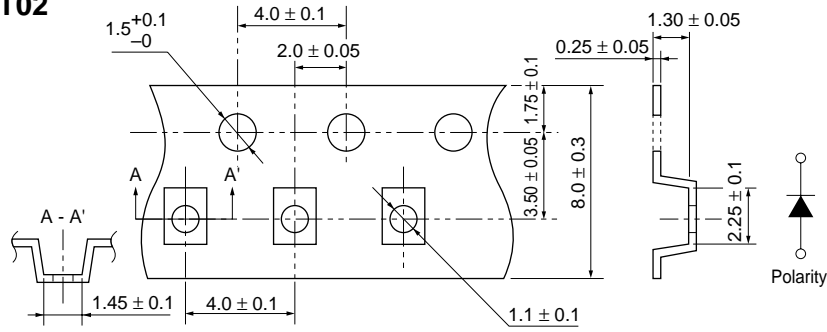

**T03**

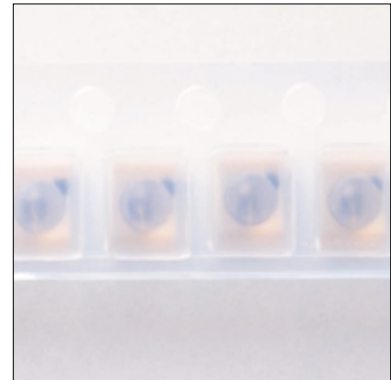
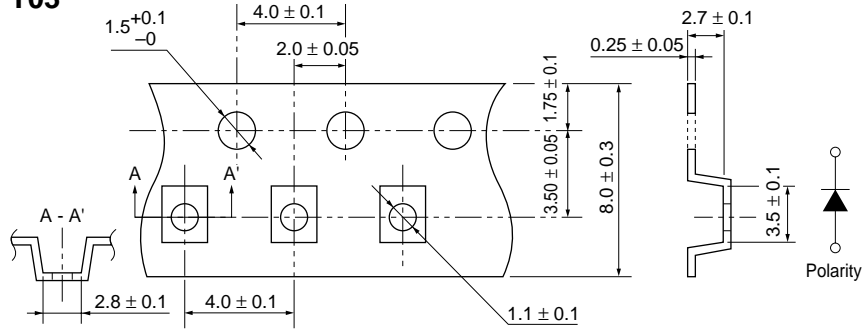

**T04**

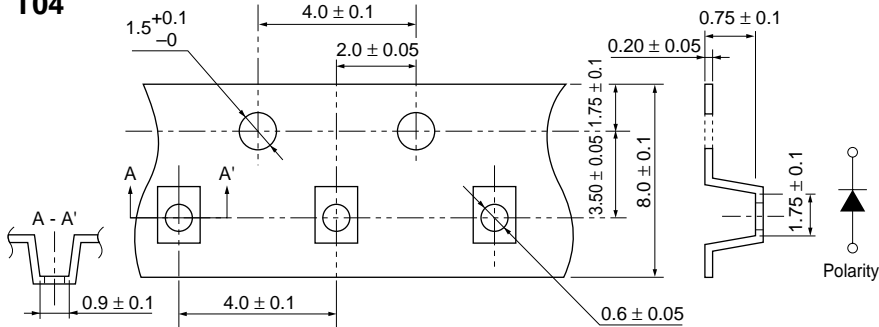

**T05**

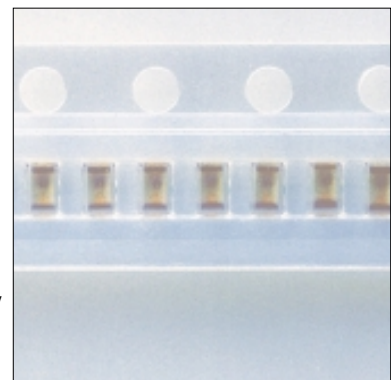
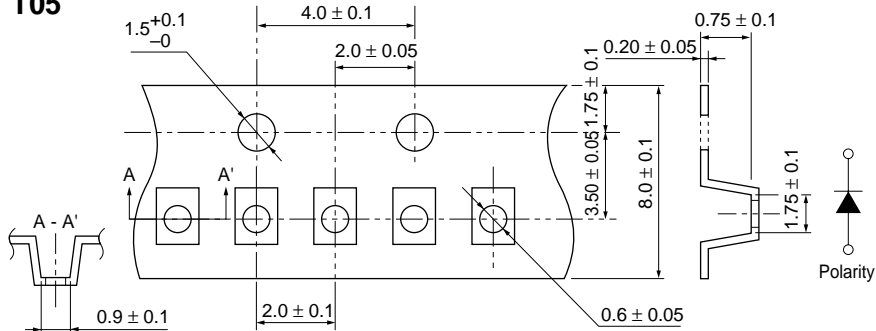

# 5 Packing Specifications

## T09, T10

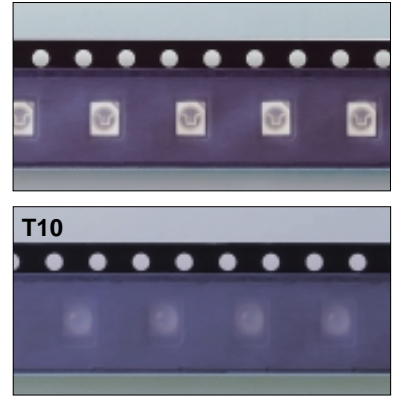
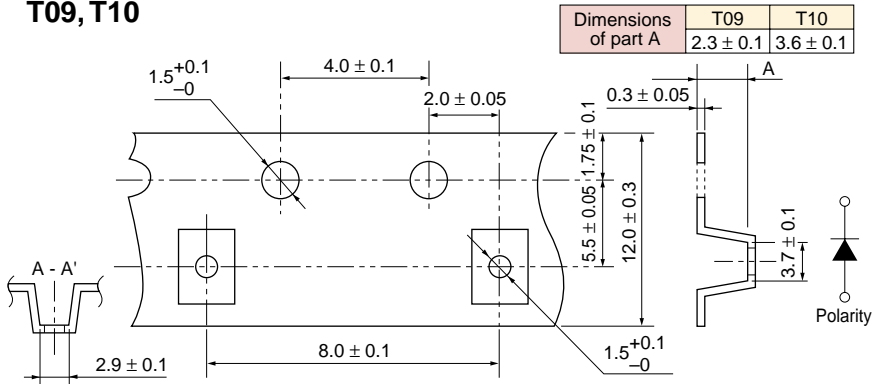

## T11

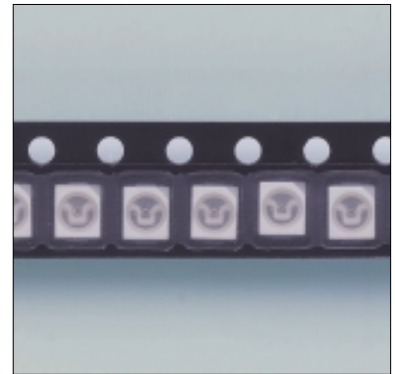
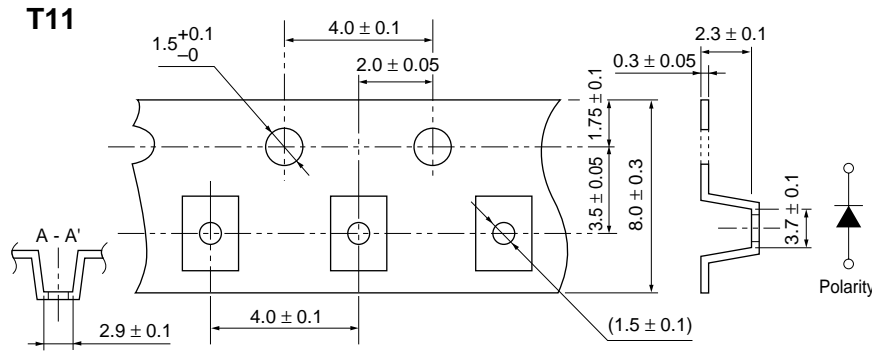

(Unit: mm)

## Reel dimensions

### T02, T03, T04, T05, T11

Corresponds to  
EIAJ RRM08B

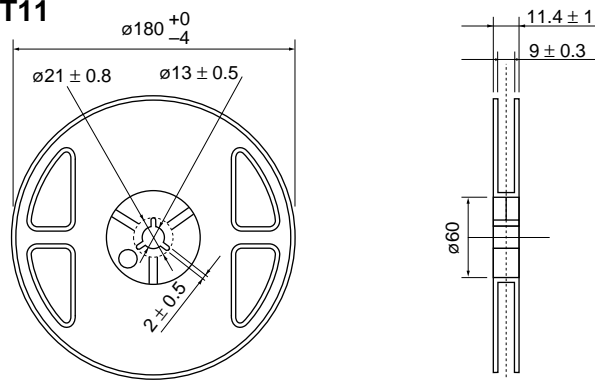

### T09, T10

Corresponds to  
EIAJ RRM12B

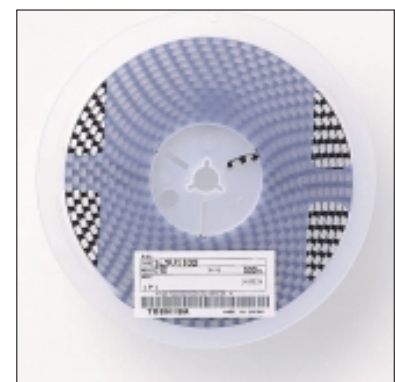
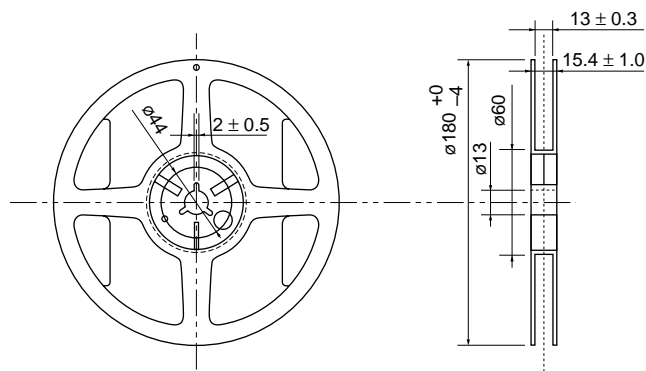

# 6 Handling Precautions

## 1. Lead Type

### 1-1 Mounting on a Printed Circuit Board (PCB)

#### Soldering conditions

Type of soldering	Conditions	Precautions
Solder dip	Solder temperature: 260°C max Dipping time: 3 seconds max Soldering portion of lead: at least 2 mm away from the body of the device	<ul style="list-style-type: none"> <li>● When the temperature of the device itself is rising, please be careful not to apply mechanical stress to it.</li> <li>● During solder dip, do not apply mechanical stress between leads of a device; measures should taken especially in order to prevent temperature rise in a device.</li> <li>● It is recommended to radiate heat by gripping leads with pliers or a tweezer when the working condition permits doing so.</li> </ul>
Manual soldering (using soldering iron)	Iron tip temperature: 300°C max Soldering iron capacity: 30 W max Soldering time: 3 seconds max Soldering portion of lead: at least 2 mm away from the body of the device	

#### ●Soldering precaution for TLRME68TG Series

These newly designed LED lamps are less prone to the effects of stress during automatic mounting than conventional LED lamps. Hence, this type of LED lamp can be mounted close to a through-hole on the PCB. However, if one of these lamps is subjected to excessive stress, the resin part may break or the lamp may be damaged in such a way that it will not emit light. Before using this type of LED lamp, please carefully read the technical datasheets for the product in question.

### 1-2 Mounting Precautions

#### Lead forming

The lead should be formed at least 5 mm away from the body of the device.

Care must be taken to ensure that no stress is applied to the resin.

#### Mechanical stress on leads

If stress is applied to leads during soldering, or if excessive stress such as tension, twisting or compression is applied between leads while the temperature is still high immediately after soldering the device may be open circuited and will afterwards be unable to perform according to its specifications. Instead, positions and directions of leads must be corrected after cooling.

#### Cleaning

##### 1) Ultrasonic cleaning

The resin material of the device package may be harmed if ultrasonic cleaning is conducted after soldering and a solvent is used remove flux, or if non-recommended chemicals are used for brushing.

Note: The amount of stress applied to a device during ultrasonic cleaning will vary according to the size of the cleaning tank, the output power of the oscillator, the size of the PCB, and the mounting method. Please confirm test results under actual conditions before starting cleaning in production line.

Ultrasonic cleaning should normally be conducted with an ultrasonic output of 300 W or lower and should be completed within 30 seconds. These requirements may vary according to the size of the cleaning tank and the PCB.

##### 2) Solvent

Depending on the solvent used, the sealed resin of a device package may be harmed. It is therefore necessary to confirm in advance that the solvent used for cleaning will not harm the resin. (Also, the use of solvents containing freon is restricted so as to prevent destruction of the ozone layer.) Before using any chemical, check whether the solvent will harm the device package resin.

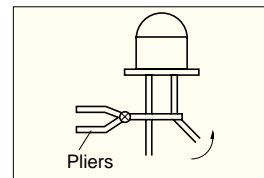

### 1-3 Reliability

InGaAlP series LEDs are known for their high reliability compared to other LED devices and exhibit excellent characteristics particularly in high-temperature, high-humidity environments. However, before using these devices in equipment, be sure to perform adequate testing; in addition, include safety margins in design specifications.

### 1-4 U-Series Lead Sheathing

The new InGaAlP-type U-Series uses tin (Sn) plating instead of solder dip as the sheathing for leads.

Lead-free (Pb-free) sheathing helps to preserve the environment. When using this series, please note the following:

1) The solderability of tin plate is equivalent to that of solder dip. However, avoid storing U-Series devices for long periods and try to use them as soon as possible.

2) Since there is exposed iron (Fe) on the cut section of the lead tie-bar, leads may get rusty. Treat (protect) the surface of leads where necessary, particularly when devices are to be used in salty environments.

For detailed recommended storage conditions, see the usage cautions in the databook.

Toshiba plan to introduce lead-free (Pb-free) sheathing of leads gradually for conventional LEDs as well.

### 1-5 Four-element LEDs

This type of visible LED lamp also emits some IR light. If a photodetector is located near the LED lamp, please ensure that it will not be affected by this IR light.

## 2. SMD Type

### 2-1 Recommended Soldering Conditions

#### Temperature profile (reflow)

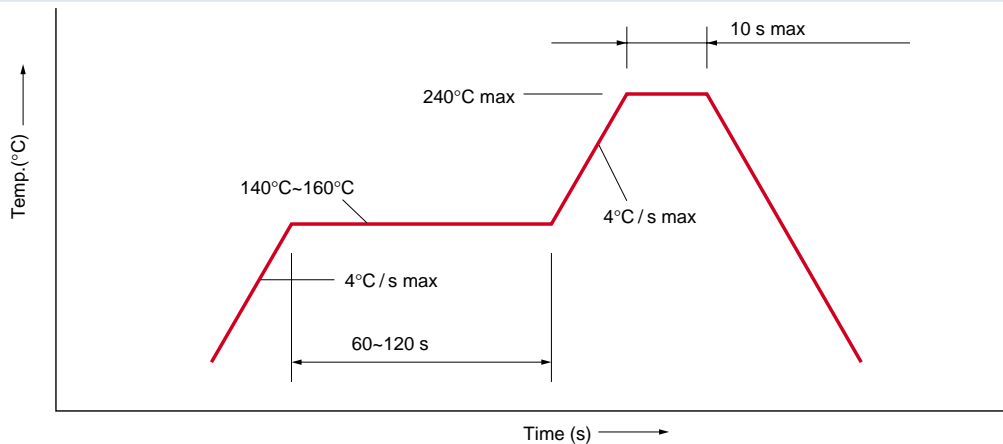

#### Soldering pad dimensions

Based on the specifications of the individual product.  
Please refer to each datasheets. (Page 28, 30, 32, 34 and 36)

#### ■ TL\*1002A Series, TL\*1005B Series, TL\*1008A Series

- Please perform the first reflow soldering with reference to the above temperature profile within 168 h after package is opened.
- If a second reflow soldering, it should be performed within 168 h of the first reflow under the above temperature profile conditions.
- Storage conditions before second reflow soldering: 30°C, 60% RH or lower
- Do not perform flow soldering.

#### ■ TL\*1100 Series

- Please perform the first reflow soldering with reference to the above temperature profile within 168 h after package is opened.
- If a second reflow soldering, it should be performed within 168 h of the first reflow under the above temperature profile conditions.
- Storage conditions before second reflow soldering: 30°C, 60% RH or lower
- Please ask your nearest Toshiba distributor for more details before performing flow soldering.

#### ■ TL\*1102 Series

- Please perform the first reflow soldering with reference to the above temperature profile within 168 h after package is opened.
- Please ask your nearest Toshiba distributor for more details before performing repeat reflow soldering.
- Do not perform flow soldering.

#### Manual soldering

Manual soldering should be performed within 3 s at a maximum temperature of 300°C using a 25 W soldering iron.  
Manual soldering should be performed only once at each soldering spot.

### 2-2 Mounting Precautions

- Do not apply stress to the resin part at high temperature.
- The resin can easily be scratched. Avoid friction between the resin and any hard materials.
- When installing the PCB in a product, ensure that the device does not come into contact with other components.
- The product should be mounted widthwise on the PCB is across the width of the board.
- Design the PCB layout so as to minimize force which will be exerted on the device if the PCB warps.
- When the device is mounted on a flexible PCB, before using the product, ensure that there is no problem with LED reliability.

#### Mounting example

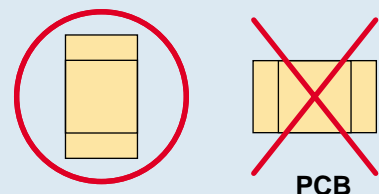

# 6 Handling Precautions

When cleaning is required after soldering

Chemical	AK225, alcohol
Temperature and time	50°C x 30 s and 30°C x 30 mins
Ultrasonic cleaning	300 W or less



## 2-3 Moisture-Proof Packaging

To avoid moisture absorption by the resin, the devices are packed in an aluminum envelope with silica gel.

Because the optical characteristics of the device can be affected during soldering due to gas expansion resulting from previous moisture absorption, store under the following conditions after opening.

### Caution:

1. The moisture proof bag may be stored unopened within 6 months at the following conditions.  
Temperature: 5°C~30°C  
Humidity: 90% (max)
  2. After opening the moisture proof bag, the devices should be assembled within 168 hours in an environment of 5°C to 30°C/60% RH or below.
  3. If upon opening, the moisture indicator card shows humidity 30% or above (Color of indication changes to pink) or the expiration date has passed, the devices should be baked in taping with reel.
- After baking, use the baked devices within 72 hours, but perform baking only once.  
Baking conditions: 60°C ± 5°C, for 12 to 24 hours.  
Expiration date: 6 months from sealing date, which is imprinted on the same side as this label affixed.
4. Repeated baking can cause the peeling strength of the taping to change, than leads to trouble in mounting. Furthermore, prevent the devices from being destructed against static electricity for baking of it.
  5. If the packing material of laminate would be broken, the hermeticity would deteriorate. Therefore, do not throw or drop the packed devices.

## 2-4 Design Precautions (for the LEDs general characteristics)

### Adhere strictly to maximum ratings

The maximum ratings are a set of specified values which must not be exceeded, even for an instant. For the ratings of a specific device, please refer to the individual specifications for the device in question.

### Adhere strictly to the temperature range in which operations are guaranteed.

The recommended operating conditions for each device are those necessary to guarantee that the device will operate as specified in the datasheets. To ensure high reliability when using the device, derate the maximum ratings for current, power and temperature as recommended in the individual specifications for the device in question.

### Temperature and humidity environment

Compared to mechanical components, semiconductor devices are generally highly sensitive to temperature. Since a the device's electrical characteristics are subject to the usage temperature, first investigate the product's temperature characteristics, and, if necessary, incorporate derating into the design. If the device is used outside the guaranteed operating temperature range, its electrical characteristics cannot be guaranteed and performance deterioration may result.

### Viewing angle characteristic

Each product has its own distinct viewing angle characteristic. Select the product whose viewing angle characteristic best meets the requirements for the device in which it will be used. The viewing angle is based on the angle  $\theta$  between the axis on which the luminous intensity of light from the optical source is 100% and any axis on which the luminous intensity is 50%. The angle between these two axes is referred to as the LED's half-angle value. For the viewing angle characteristic of a particular product, please refer to the datasheets for the product in question.

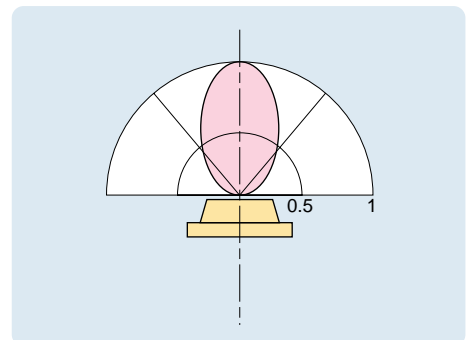

## Thermal design precautions

The failure rate of semiconductor devices is greatly accelerated by high operating temperatures.

- Ensure that the ambient temperature ( $T_a$ ) of the device is not affected by exothermic heat in the device's vicinity, and that the ambient temperature is kept as low as possible.
- If the device's operating power dissipation is comparatively large, consider forced-air cooling, the selection of different PCB materials, or the use of heat-dispersion sink, for example. These measures can lower the thermal resistance of the package.

## Temperature dependence

### • Luminance

Because the light recoupling rate of the LED is temperature dependent, as the temperature rises, the intensity of the light emission falls. To avoid a temperature rise in the connection resulting from power dissipation, Toshiba recommends a pulse driving design and a case with good heat dispersion characteristics. Before using the device, check that there are no problems with set use.

### • Color tone (Light emission wavelength)

In LEDs, a temperature rise in the junction resulting from power dissipation causes the light emission wavelength to shift to the longer side. Toshiba therefore recommends a thermal design that avoids temperature rise in the junction due to power dissipation.

Reference value:

$$\Delta\lambda = 0.2 \text{ nm} \times \Delta T_j \quad \Delta T_j: \text{Emitted-light device junction temperature}$$

Example: Temperature dependence of optical output

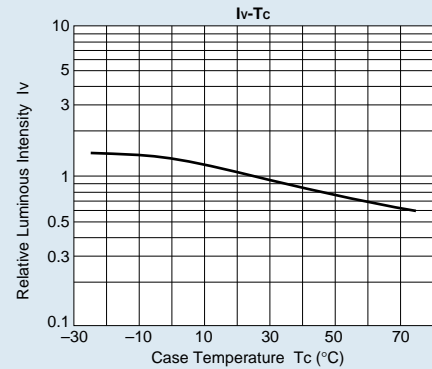

## Light output deterioration

The lifespan of the emitted-light device is greatly affected not only by the device's own particular lifespan characteristics, but by the operating conditions and the operating environment as well. Accordingly, when selecting the emitted-light device and setting the operating conditions, we recommend checking first the several characteristics affecting lifespan.

For reliability data on individual products, including lifespan data, inquire at a Toshiba sales office or agency.

### TLOE1002 Operation life test

Test Condition:  $I_f = 25 \text{ mA}$ , Duty = 100%,  $T_a = 25^\circ\text{C}$ ,  $N = 30$

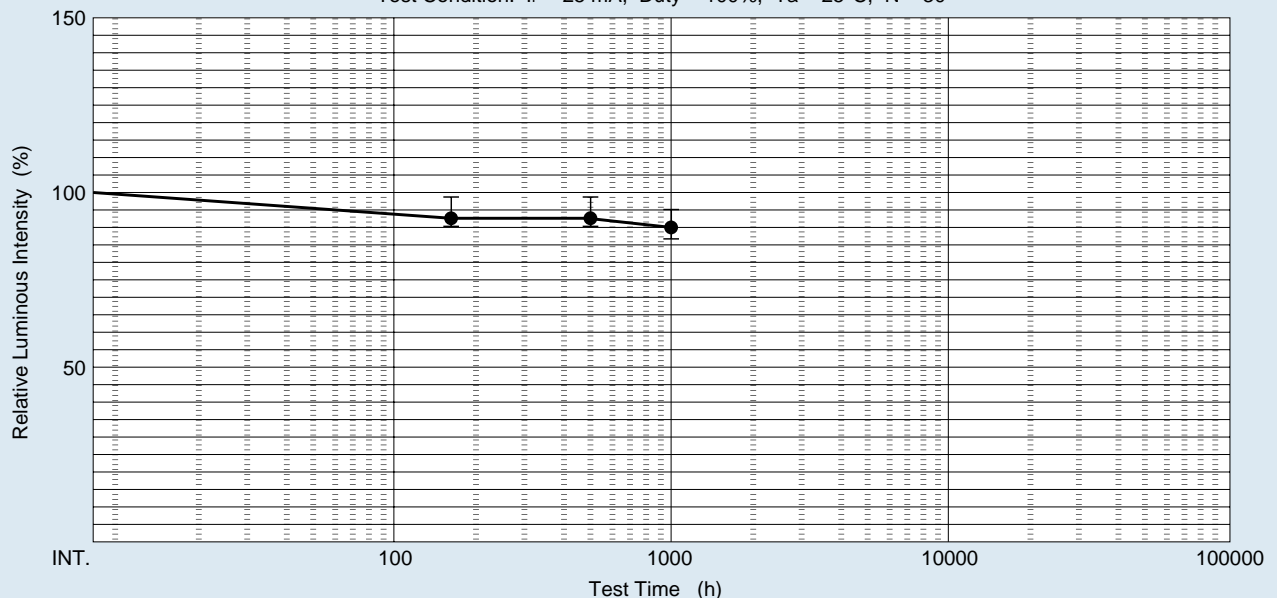

- Visible LED lamps made of InGaAlP will also emit some IR light. If a photodetector is located near an LED lamp, please ensure that it will not be affected by this IR light.

# 7 Product Manufactured Overseas

Place of Manufacture: Toshiba Semiconductor Thailand Co., Ltd. → Abbreviation: TST

Manufactured products: High-brightness lead-type LED lamps

The suffix 'T' in brackets at the end of a product number indicates that the product was manufactured by Toshiba Semiconductor Thailand Co., Ltd. The luminosity rank for the product, if there is one, is also specified within the brackets, before the suffix 'T'.

• Example: TLRH157P (TU, T)

The product number above indicates that the product was manufactured in Thailand and that it is available with luminosity ranks of T and U.

If your products are assembled outside Japan, high-brightness lead-type LED lamps can be supplied by Toshiba Semiconductor Thailand Co., Ltd. upon request.

For information about Thai-manufactured products, please contact your nearest Toshiba distributor.

With Lead Stopper Type	Straight Type	With Lead Stopper Type	Straight Type	With Lead Stopper Type	Straight Type
S4E38XX(T)		TLPGE11T(T)	TLPGE11TP(T)	TLRMH151(T)	TLRMH151P(T)
TLGE11T(T)	TLGE11TP(T)	TLPGE158(T)	TLPGE158P(T)	TLRMH156(T)	TLRMH156P(T)
TLGE158(T)	TLGE158P(T)	TLPGE159(T)	TLPGE159P(T)	TLRMH157(T)	TLRMH157P(T)
TLGE159(T)	TLGE159P(T)	TLPGE183(T)	TLPGE183P(T)	TLSE156(T)	TLSE156P(T)
TLGE174(T)	TLGE174P(T)	TLPGE18T(T)	TLPGE18TP(T)	TLSE157(T)	TLSE157P(T)
TLGE183(T)	TLGE183P(T)	TLPGE19T(T)	TLPGE19TP(T)	TLSE16C(T)	TLSE16CP(T)
TLGE18C(T)	TLGE18CP(T)	TLPGE23T(T)	TLPGE23TP(T)	TLSE16T(T)	TLSE16TP(T)
TLGE18T(T)	TLGE18TP(T)	TLPGE50T(T)		TLSE17T(T)	TLSE17TP(T)
TLGE19T(T)	TLGE19TP(T)	TLPGE53T(T)		TLSE180(T)	TLSE180P(T)
TLGE23T(T)	TLGE23TP(T)	TLPGE62T(T)		TLSE20T(T)	TLSE20TP(T)
TLGE25T(T)..	TLGE25TP(T)	TLRE11T(T)	TLRE11TP(T)	TLSE27C(T)	
TLGE260(T)		TLRE156A(T)	TLRE156AP(T)	TLSE50T(T)	
TLGE262(T)		TLRE157A(T)	TLRE157AP(T)	TLSE53T(T)	
TLGE27C(T)		TLRE16C(T)	TLRE16CP(T)	TLSE62T(T)	
TLGE50T(T)		TLRE16T(T)	TLRE16TP(T)	TLSH156(T)	TLSH156P(T)
TLGE53C(T)		TLRE17T(T)	TLRE17TP(T)	TLSH157(T)	TLSH157P(T)
TLGE53T(T)		TLRE180A(T)	TLRE180AP(T)	TLSH180(T)	TLSH180P(T)
TLGE60T(T)		TLRE20T(T)	TLRE20TP(T)	TLYE11T(T)	TLYE11TP(T)
TLGE62T(T)		TLRE25T(T)	TLRE25TP(T)	TLYE156A(T)	TLYE156AP(T)
TLOE11T(T)	TLOE11TP(T)	TLRE27C(T)		TLYE157A(T)	TLYE157AP(T)
TLOE156A(T)	TLOE156AP(T)	TLRE50T(T)		TLYE16C(T)	TLYE16CP(T)
TLOE157A(T)	TLOE157AP(T)	TLRE53T(T)		TLYE16T(T)	TLYE16TP(T)
TLOE16C(T)	TLOE16CP(T)	TLRE60T(T)		TLYE17T(T)	TLYE17TP(T)
TLOE16T(T)	TLOE16TP(T)	TLRE62T(T)		TLYE180A(T)	TLYE180AP(T)
TLOE17T(T)	TLOE17TP(T)	TLRH156(T)	TLRH156P(T)	TLYE20T(T)	TLYE20TP(T)
TLOE180A(T)	TLOE180AP(T)	TLRH157(T)	TLRH157P(T)	TLYE25T(T)	TLYE25TP(T)
TLOE20T(T)	TLOE20TP(T)	TLRH180(T)	TLRH180P(T)	TLYE260A(T)	
TLOE25T(T)	TLOE25TP(T)	TLRH262(T)		TLYE262A(T)	
TLOE266(T)	TLOE266P(T)	TLRME16C(T)	TLRME16CP(T)	TLYE27C(T)	
TLOE27C(T)		TLRME16T(T)	TLRME16TP(T)	TLYE50T(T)	
TLOE50T(T)		TLRME17D(T)	TLRME17DP(T)	TLYE53T(T)	
TLOE53T(T)		TLRME17T(T)	TLRME17TP(T)	TLYE60T(T)	
TLOE60T(T)		TLRME20T(T)	TLRME20TP(T)	TLYE62T(T)	
TLOE62T(T)		TLRME27C(T)		TLYH151(T)	TLYH151P(T)
TLOH156(T)	TLOH156P(T)	TLRME50T(T)		TLYH156(T)	TLYH156P(T)
TLOH157(T)	TLOH157P(T)	TLRME53T(T)		TLYH157(T)	TLYH157P(T)
TLOH180(T)	TLOH180P(T)	TLRME62T(T)		TLYH180(T)	TLYH180P(T)



# 8 Application Note

## ● Considerations for Selecting of SMD Lamps

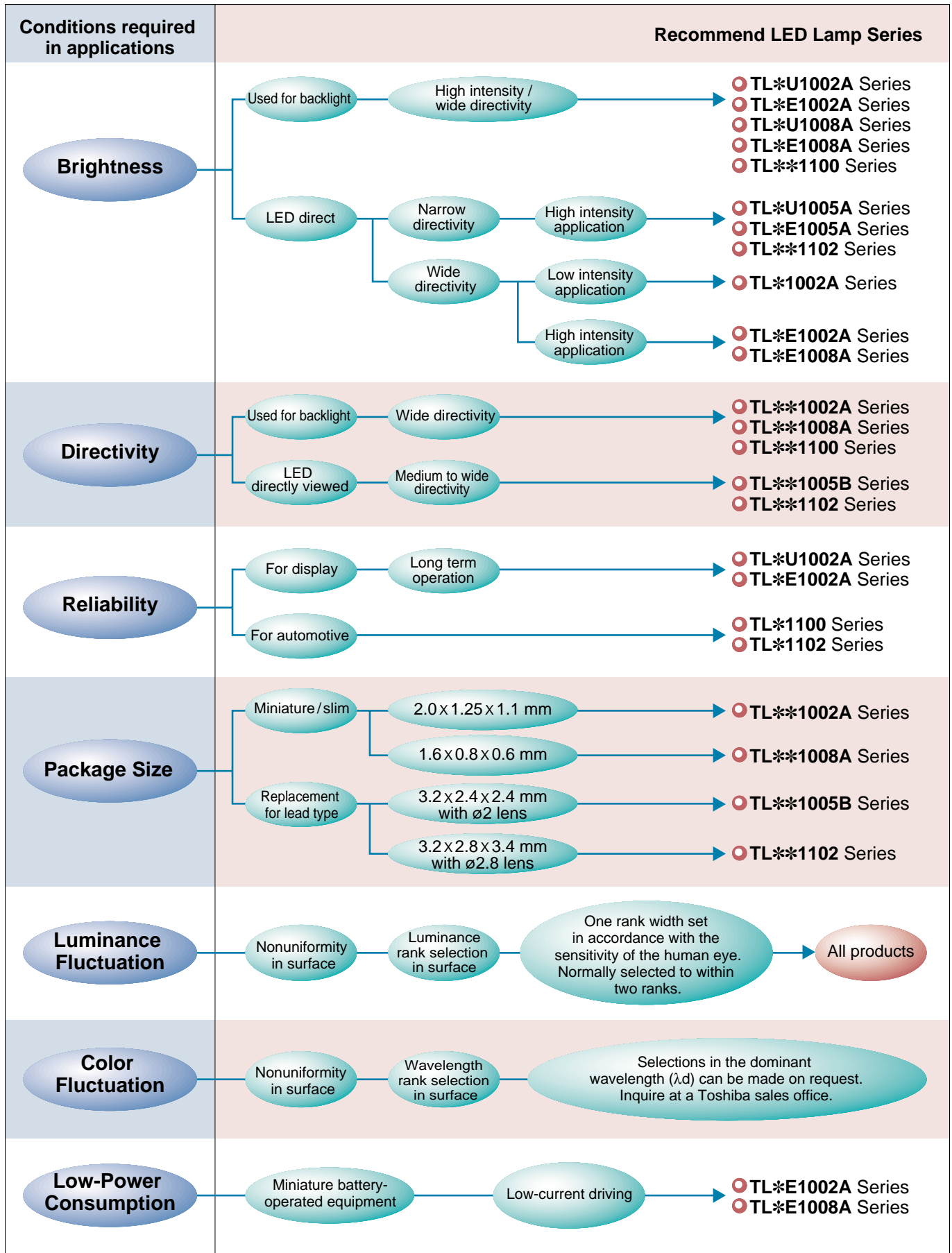

# 9 Product Number Index

Product Number	Page
<b>● S4F Series</b>	
S4F42Q1(T09)	34
S4F42Z1(T09)	34
S4F43Q1(T10)	36
S4F43Z1(T10)	36
<b>● TLAU Series</b>	
TLAU1002A(T02)	30
TLAU1008A(T04)	28
TLAU1008A(T05)	28
<b>● TLFGE Series</b>	
TLFGE18TP	22
TLFGE19TP	22
TLFGE23TP	22
TLFGE50T	22
TLFGE53T	22
TLFGE62T	22
<b>● TLGE Series</b>	
TLGE1002A(T02)	30
TLGE1005B(T03)	32
TLGE1008A(T04)	28
TLGE1008A(T05)	28
TLGE1100(T11)	34
TLGE1102(T10)	36
TLGE11TP	22
TLGE123	22
TLGE123(PQ)	22
TLGE125	22
TLGE125(QR)	22
TLGE158P	22
TLGE158P(QR)	22
TLGE159P	22
TLGE159P(ST)	22
TLGE160	22
TLGE160(TU)	22
TLGE174P	22
TLGE183P	22
TLGE18CP	22
TLGE18TP	22
TLGE19TP	22
TLGE23TP	22
TLGE247	22
TLGE247(PQ)	22
TLGE248	22
TLGE25TP	22
TLGE260	22
TLGE260(KL)	22
TLGE262	22
TLGE262(NP)	22
TLGE27C	22
TLGE50T	22
TLGE53T	22
TLGE60T	22
TLGE62T	22

Product Number	Page
TLGE68TG	22
<b>● TLGU Series</b>	
TLGU1002A(T02)	30
TLGU1008A(T04)	28
TLGU1008A(T05)	28
TLGU1100(T09)	34
TLGU1102(T10)	36
TLGU13CP	24
TLGU13DP	24
TLGU18CP	24
TLGU18TP	24
TLGU23TP	24
TLGU27C	24
TLGU50T	24
TLGU53C	24
TLGU53D	24
TLGU53T	24
TLGU62T	24
<b>● TLOE Series</b>	
TLOE1002A(T02)	30
TLOE1005B(T03)	32
TLOE1008A(T04)	28
TLOE1008A(T05)	28
TLOE1100(T11)	34
TLOE1102(T10)	36
TLOE11TP	18
TLOE156AP	18
TLOE156AP(RS)	18
TLOE157AP	18
TLOE157AP(ST)	18
TLOE160A	18
TLOE160A(ST)	18
TLOE16CP	18
TLOE16TP	18
TLOE17TP	18
TLOE180AP	18
TLOE180AP(UV)	18
TLOE20TP	18
TLOE248	18
TLOE25TP	18
TLOE260A	18
TLOE260A(LM)	18
TLOE261AP	18
TLOE261AP(LM)	18
TLOE262A	18
TLOE262A(PQ)	18
TLOE263AP	18
TLOE263AP(PQ)	18
TLOE266	18
TLOE266(RS)	18
TLOE27C	18
TLOE50T	18
TLOE53T	18

Product Number	Page
TLOE60T	18
TLOE62T	18
<b>● TLOH Series</b>	
TLOH1100(T09)	34
TLOH1102(T10)	36
TLOH156P	18
TLOH156P(ST)	18
TLOH157P	18
TLOH157P(TU)	18
TLOH160	18
TLOH160(TU)	18
TLOH16TP	18
TLOH17TP	18
TLOH180P	18
TLOH180P(VW)	18
TLOH190P	18
TLOH190P(XY)	18
TLOH20TP	18
TLOH262	18
TLOH262(PQ)	18
TLOH38TP	18
<b>● TLOU Series</b>	
TLOU1002A(T02)	30
TLOU1005A(T03)	32
TLOU1008A(T04)	28
TLOU1008A(T05)	28
TLOU1100(T09)	34
TLOU1102(T10)	36
TLOU113P	18
TLOU113P(RS)	18
TLOU114P	18
TLOU114P(NP)	18
TLOU123	18
TLOU124	18
TLOU156P	18
TLOU156P(RS)	18
TLOU160	18
TLOU172P	18
TLOU180P	18
TLOU180P(UV)	18
TLOU248	18
TLOU262	18
TLOU262(PQ)	18
TLOU267	18
<b>● TLPGE Series</b>	
TLPGE1002A(T02)	30
TLPGE1005B(T03)	32
TLPGE1008A(T04)	28
TLPGE1008A(T05)	28
TLPGE1100(T11)	34
TLPGE1102(T10)	36
TLPGE11TP	22
TLPGE125	22

Product Number	Page
TLPGE158P	22
TLPGE159P	22
TLPGE160	22
TLPGE183P	22
TLPGE183P(ST)	22
TLPGE18TP	22
TLPGE19TP	22
TLPGE23TP	22
TLPGE247	22
TLPGE247(LM)	22
TLPGE262	22
TLPGE50T	22
TLPGE53T	22
TLPGE62T	22
<b>● TLPGU Series</b>	
TLPGU1002A(T02)	30
TLPGU1008A(T04)	28
TLPGU1008A(T05)	28
TLPGU1100(T09)	34
TLPGU1102(T10)	36
TLPGU13CP	24
TLPGU13DP	24
TLPGU18TP	24
TLPGU23TP	24
TLPGU50T	24
TLPGU53C	24
TLPGU53D	24
TLPGU53T	24
TLPGU62T	24
<b>● TLPYE Series</b>	
TLPYE18T	20
TLPYE19TP	20
TLPYE23TP	20
TLPYE50T	20
TLPYE53T	20
TLPYE62T	20
<b>● TLRE Series</b>	
TLRE1002A(T02)	30
TLRE1005B(T03)	32
TLRE1008A(T04)	20
TLRE1008A(T05)	20
TLRE1100(T11)	34
TLRE1102(T10)	36
TLRE11TP	16
TLRE138P	16
TLRE156AP	16
TLRE156AP(PQ)	16
TLRE157AP	16
TLRE157AP(RS)	16
TLRE160A	16
TLRE160A(RS)	16
TLRE16CP	16
TLRE16TP	16

Product Number	Page
TLRE17TP	16
TLRE180AP	16
TLRE180AP(TU)	16
TLRE20TP	16
TLRE248	16
TLRE25TP	16
TLRE260A	16
TLRE261AP	16
TLRE262A	16
TLRE262A(MN)	16
TLRE263AP	16
TLRE263AP(MN)	16
TLRE27C	16
TLRE50T	16
TLRE53T	16
TLRE60T	16
TLRE62T	16
<b>● TLRH Series</b>	16
TLRH1100(T09)	34
TLRH1102(T10)	36
TLRH156P	14
TLRH156P(QR)	14
TLRH157P	14
TLRH157P(ST)	14
TLRH160	14
TLRH160(ST)	14
TLRH180P	14
TLRH180P(UV)	14
TLRH190P	14
TLRH190P(WX)	14
TLRH247	14
TLRH247(PQ)	14
TLRH262	14
TLRH262(NP)	14
<b>● TLRME Series</b>	
TLRME16TP	16
TLRME17DP	16
TLRME17TP	16
TLRME20TP	16
TLRME27C	16
TLRME50T	16
TLRME53T	16
TLRME62T	16
TLRME68TG	16
<b>● TLRMH Series</b>	
TLRMH151P	14
TLRMH156P	14
TLRMH157P	14
TLRMH16TP	14
TLRMH17TP	14
TLRMH20TP	14
TLRMH265P	14
TLRMH38TP	14

Product Number	Page
<b>● TLRU Series</b>	
TLRU1002A(T02)	30
<b>● TLSE Series</b>	
TLSE1002A(T02)	30
TLSE1005B(T03)	32
TLSE1008A(T04)	28
TLSE1008A(T05)	28
TLSE1100(T11)	34
TLSE1102(T10)	36
TLSE156P	16
TLSE156P(RS)	16
TLSE157P	16
TLSE157P(ST)	16
TLSE16CP	16
TLSE16TP	16
TLSE17TP	16
TLSE180P	16
TLSE20TP	16
TLSE27C	16
TLSE50T	16
TLSE53T	16
TLSE62T	16
<b>● TLSH Series</b>	
TLSH1100(T09)	34
TLSH1102(T10)	36
TLSH125	14
TLSH156P	14
TLSH156P(RS)	14
TLSH157P	14
TLSH157P(ST)	14
TLSH160	14
TLSH16TP	14
TLSH17TP	14
TLSH180P	14
TLSH180P(VW)	14
TLSH20TP	14
TLSH38TP	14
<b>● TLSU Series</b>	
TLSU1002A(T02)	30
TLSU1005A(T03)	32
TLSU1008A(T04)	28
TLSU1008A(T05)	28
TLSU1100(T09)	34
TLSU1102(T10)	36
TLSU113P	14
TLSU114P	14
TLSU114P(NP)	14
TLSU123	14
TLSU123(PQ)	14
TLSU124	14
TLSU124(MN)	14
TLSU125	14
TLSU125(PQ)	14

Product Number	Page
TLSU126	14
TLSU156P	14
TLSU156P(QR)	14
TLSU160	14
TLSU163	14
TLSU164	14
TLSU180P	14
TLSU180P(TU)	14
TLSU262	14
TLSU262(NP)	14
TLSU268G	14
<b>● TLYE Series</b>	
TLYE1002A(T02)	30
TLYE1005B(T03)	32
TLYE1008A(T04)	28
TLYE1008A(T05)	28
TLYE1100(T11)	34
TLYE1102(T10)	36
TLYE11TP	20
TLYE156AP	20
TLYE156AP(QR)	20
TLYE157AP	20
TLYE157AP(ST)	20
TLYE160A	20
TLYE160A(ST)	20
TLYE16CP	20
TLYE16TP	20
TLYE17TP	20
TLYE18TP	20
TLYE180AP	20
TLYE180AP(UV)	20
TLYE20TP	20
TLYE25TP	20
TLYE260A	20
TLYE260A(KL)	20
TLYE261AP	20
TLYE261AP(JK)	20
TLYE262A	20
TLYE262A(NP)	20
TLYE263AP	20
TLYE263AP(NP)	20
TLYE27C	20
TLYE50T	20
TLYE53T	20
TLYE60T	20
TLYE62T	20
TLYE68TG	20
<b>● TLYH Series</b>	
TLYH1100(T09)	34
TLYH1102(T10)	36
TLYH151P	20
TLYH156P	20
TLYH156P(RS)	20

Product Number	Page
TLYH157P	20
TLYH157P(TU)	20
TLYH160	20
TLYH160(TU)	20
TLYH16TP	20
TLYH17TP	20
TLYH180P	20
TLYH180P(VW)	20
TLYH190P	20
TLYH190P(XY)	20
TLYH20TP	20
TLYH247	20
TLYH247(QR)	20
TLYH262	20
TLYH262(PQ)	20
TLYH38TP	20
<b>● TLYU Series</b>	
TLYU1002A(T02)	30
TLYU1005A(T03)	32
TLYU1008A(T04)	28
TLYU1008A(T05)	28
TLYU1100(T09)	34
TLYU1102(T10)	36
TLYU113P	20
TLYU114P	20
TLYU114P(MN)	20
TLYU123	20
TLYU123(NP)	20
TLYU124	20
TLYU124(MN)	20
TLYU156P	20
TLYU156P(QR)	20
TLYU160	20
TLYU160(ST)	20
TLYU172P	20
TLYU180P	20
TLYU180P(TU)	20
TLYU262	20
TLYU262(MN)	20
TLYU267	20

**Toshiba America  
Electronic Components, Inc.**

**Headquarters-Irvine, CA**  
9775 Toledo Way, Irvine, CA 92618, U.S.A.  
Tel: (949)455-2000 Fax: (949)859-3963

**Boulder, CO**  
3100 Arapahoe Avenue, Ste. 500,  
Boulder, CO 80303, U.S.A.  
Tel: (303)442-3801 Fax: (303)442-7216

**Boynton Beach, FL(Orlando)**  
11924 W. Forest Hill Blvd., Ste. 22-337,  
Boynton Beach, FL 33414, U.S.A.  
Tel: (561)374-6193 Fax: (561)374-6194

**Deerfield, IL(Chicago)**  
One Pkwy., North, Suite 500, Deerfield,  
IL 60015-2547, U.S.A.  
Tel: (847)945-1500 Fax: (847)945-1044

**Duluth, GA(Atlanta)**  
3700 Crestwood Parkway, Ste. 460,  
Duluth, GA 30096, U.S.A.  
Tel: (770)931-3363 Fax: (770)931-7602

**Edison, NJ**  
2035 Lincoln Hwy. Ste. #3000, Edison  
NJ 08817, U.S.A.  
Tel: (732)248-8070 Fax: (732)248-8030

**Orange County, CA**  
2 Venture Plaza, #500 Irvine, CA 92618, U.S.A.  
Tel: (949)453-0224 Fax: (949)453-0125

**Portland, OR**  
1700 NW 167th Place, #240,  
Beaverton, OR 97006, U.S.A.  
Tel: (503)629-0818 Fax: (503)629-0827

**Raleigh, NC**  
5511 Capitol Center Dr., #114,  
Raleigh, NC 27606, U.S.A.  
Tel: (919)859-2800 Fax: (919)859-2898

**Richardson, TX(Dallas)**  
777 East Campbell Rd., Suite 650, Richardson,  
TX 75081, U.S.A.  
Tel: (972)480-0470 Fax: (972)235-4114

**San Jose Engineering Center, CA**  
1060 Rincon Circle, San Jose, CA 95131, U.S.A.  
Tel: (408)526-2400 Fax: (408)526-2410

**Wakefield, MA(Boston)**  
401 Edgewater Place, Suite #360, Wakefield,  
MA 01880-6229, U.S.A.  
Tel: (781)224-0074 Fax: (781)224-1095

**Toshiba Do Brasil S.A.**

**Electronic Components Div.**  
Estrada Dos Alvarengas, 5. 500-Bairro Alvarenga  
09850-550-Sao Bernardo do campo - SP  
Tel: (011)7689-7171 Fax: (011)7689-7189

**Toshiba Electronics Europe GmbH**

**Düsseldorf Head Office**  
Hansaallee 181, D-40549 Düsseldorf  
Germany  
Tel: (0211)5296-0 Fax: (0211)5296-400

**München Office**  
Büro München Hofmannstrasse 52,  
D-81378, München, Germany  
Tel: (089)748595-0 Fax: (089)748595-42

**Toshiba Electronics France SARL**  
Immeuble Robert Schumann 3 Rue de Rome,  
F-93561, Rosny-Sous-Bois, Cedex, France  
Tel: (1)48-12-48-12 Fax: (1)48-94-51-15

**Toshiba Electronics Italiana S.R.L.**  
Centro Direzionale Colleoni  
Palazzo Perseo Ingr. 2-Piano 6,  
Via Paracelso n.12,  
1-20041 Agrate Brianza Milan, Italy  
Tel: (039)68701 Fax:(039)6870205

**Toshiba Electronics España, S.A.**  
Parque Empresarial San Fernando Edificio Europa,  
1ª Planta, ES-28831 Madrid, Spain  
Tel: (91)660-6700 Fax:(91)660-6799

**Toshiba Electronics(UK) Limited**  
Riverside Way, Camberley Surrey,  
GU15 3YA, U.K.  
Tel: (01276)69-4600 Fax: (01276)69-4800

**Toshiba Electronics Scandinavia AB**  
Gustavslundsvägen 12, 2nd Floor  
S-161 15 Bromma, Sweden  
Tel: (08)704-0900 Fax: (08)80-8459

**Toshiba Electronics Asia  
(Singapore) Pte. Ltd.**

**Singapore Head Office**  
438B Alexandra Road, #06-08/12 Alexandra  
Technopark, Singapore 119968  
Tel: (278)5252 Fax: (271)5155

**Bangkok Office**  
135 Moo 5 Bangkadi Industrial Park, Tivanon Rd.,  
Bangkadi Amphur Muang Pathumthani, Bangkok, 12000,  
Thailand  
Tel: (02)501-1635 Fax: (02)501-1638

**Toshiba Electronics Trading  
(Malaysia)Sdn. Bhd.**

**Kuala Lumpur Head Office**  
Suite W1203, Wisma Consplant, No.2,  
Jalan SS 16/4, Subang Jaya, 47500 Petaling Jaya,  
Selangor Darul Ehsan, Malaysia  
Tel: (3)731-6311 Fax: (3)731-6307

**Penang Office**  
Suite 13-1, 13th Floor, Menard Penang Garden,  
42-A, Jalan Sultan Ahmad Shah,  
10050 Penang, Malaysia  
Tel: 4-226-8523 Fax: 4-226-8515

**Toshiba Electronics Philippines, Inc.**

26th Floor, Citibank Tower, Valero Street, Makati,  
Manila, Philippines  
Tel: (02)750-5510 Fax: (02)750-5511

**Toshiba Electronics Asia, Ltd.**

**Hong Kong Head Office**  
Level 11, Top Glory Insurance Building, Grand Century  
Place, No.193, Prince Edward Road West,  
Mong Kok, Kowloon, Hong Kong  
Tel: 2375-6111 Fax: 2375-0969

**Beijing Office**  
Rm 714, Beijing Fortune Building,  
No.5 Dong San Huan Bei-Lu, Chao Yang District,  
Beijing, 100004, China  
Tel: (010)6590-8795 Fax: (010)6590-8791

**Chengdu Office**  
Unit F, 18th Floor, New Times Plaza, 42 Wenwu Road,  
Xinhua Avenue, Chengdu, 610017, China  
Tel: (028)675-1773 Fax: (028)675-1065

**Shenzhen Office**  
Rm 3010-3012, Office Tower Shun Hing Square,  
Di Wang Commercial Centre, 333 ShenNan  
East Road, Shenzhen, 518008, China  
Tel: (0755)246-1582 Fax: (0755)246-1581

**Toshiba Electronics Korea Corporation**

**Seoul Head Office**  
14/F, KEC B/D, 257-7 Yangjae-Dong,  
Seocho-ku, Seoul, Korea  
Tel: (02)589-4334 Fax: (02)589-4302

**Gumi Office**  
6/F, Ssangyong Investment Securities B/D,  
56 Songjung-Dong, Gumi City  
Kyeongbuk, Korea  
Tel: (82)54-456-7613 Fax: (82)54-456-7617

**Toshiba Technology Development  
(Shanghai) Co., Ltd.**

23F, Shanghai Senmao International Building, 101  
Yin Cheng East Road, Pudong New Area, Shanghai,  
200120, China  
Tel: (021)6841-0666 Fax: (021)6841-5002

**Tsurong Xiamen Xiangyu Trading  
Co., Ltd.**

8N, Xiamen SEZ Bonded Goods Market Building,  
Xiamen, Fujian, 361006, China  
Tel: (0592)562-3798 Fax: (0592)562-3799

**Toshiba Electronics Taiwan  
Corporation**

**Taipei Head Office**  
17F, Union Enterprise Plaza Bldg. 109  
Min Sheng East Rd., Section 3, 0446 Taipei,  
Taiwan  
Tel: (02)514-9988 Fax: (02)514-7892

**Kaohsiung Office**  
16F-A, Chung-Cheng Bldg., Chung-Cheng 3Rd.,  
80027, Kaohsiung, Taiwan  
Tel: (07)222-0826 Fax: (07)223-0046

The information contained herein is subject to change without notice.

The information contained herein is presented only as a guide for the applications of our products. No responsibility is assumed by TOSHIBA for any infringements of patents or other rights of the third parties which may result from its use. No license is granted by implication or otherwise under any patent or patent rights of TOSHIBA or others.

TOSHIBA is continually working to improve the quality and reliability of its products. Nevertheless, semiconductor devices in general can malfunction or fail due to their inherent electrical sensitivity and vulnerability to physical stress. It is the responsibility of the buyer, when utilizing TOSHIBA products, to comply with the standards of safety in making a safe design for the entire system, and to avoid situations in which a malfunction or failure of such TOSHIBA products could cause loss of human life, bodily injury or damage to property. In developing your designs, please ensure that TOSHIBA products are used within specified operating ranges as set forth in the most recent TOSHIBA products specifications. Also, please keep in mind the precautions and conditions set forth in the "Handling Guide for Semiconductor Devices," or "TOSHIBA Semiconductor Reliability Handbook" etc..

The Toshiba products listed in this document are intended for usage in general electronics applications (computer, personal equipment, office equipment, measuring equipment, industrial robotics, domestic appliances, etc.). These Toshiba products are neither intended nor warranted for usage in equipment that requires extraordinarily high quality and/or reliability or a malfunction or failure of which may cause loss of human life or bodily injury ("Unintended Usage"). Unintended Usage include atomic energy control instruments, airplane or spaceship instruments, transportation instruments, traffic signal instruments, combustion control instruments, medical instruments, all types of safety devices, etc.. Unintended Usage of Toshiba products listed in this document shall be made at the customer's own risk.

Gallium arsenide (GaAs) is a substance used in some of the products described in this documents. GaAs dust and fumes are toxic. Do not break, cut or pulverize the products, or use chemicals to dissolve them. When disposing of the products, follow the appropriate regulations. Do not dispose of the products with other industrial waste or with domestic garbage.

**Website:** <http://doc.semicon.toshiba.co.jp/indexus.htm>

In Touch with Tomorrow  
**TOSHIBA**

**TOSHIBA CORPORATION**

**Electronic Devices Sales & Marketing Division**  
1-1, Shibaura 1-chome, Minato-ku, Tokyo, 105-8001, Japan  
Tel: +81-3-3457-3405 Fax: +81-3-5444-9431