

2 Watts 2 :1 Wide Input Range DC/DC Converters
Single Outputs

Key Features

- High Efficiency up to 80%
- 2:1 Input Range
- I/O Isolation 1000VDC
- Industry Standard Pinout
- SMT Technology
- Short Circuit Protection
- MTBF > 1,000,000 Hours
- External ON/OFF-Control
- Low Ripple and Noise

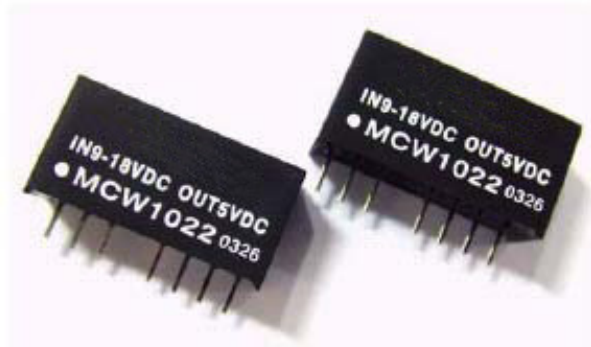

MCW1000-Series power modules are low-profile dc-dc converters that operate over input voltage ranges of 4.5-9VDC, 9-18VDC, 18-36VDC and 36-75VDC and provide precisely regulated output voltages of 3.3V, 5V, 12V.

The -40°C to +65°C operating temperature range makes it ideal for data communication equipments, mobile battery driven equipments, distributed power systems, telecommunication equipments, mixed analog/digital subsystems, process/machine control equipments, computer peripheral systems and industrial robot systems.

The modules have a maximum power rating of 2W and a typical full-load efficiency of 80%, continuous short circuit, 60mV output ripple, built-in filtering for both input and output minimizes the need for external filtering.

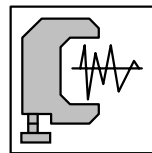

Low Noise

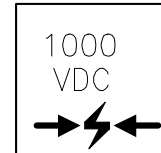

I/O Isolation

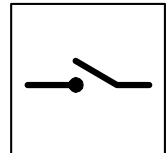

Remote on/off

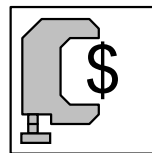

Low Cost

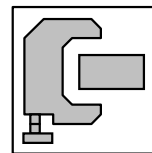

Low Profile

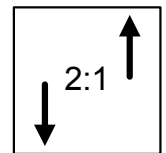

Wide Range

Block Diagram

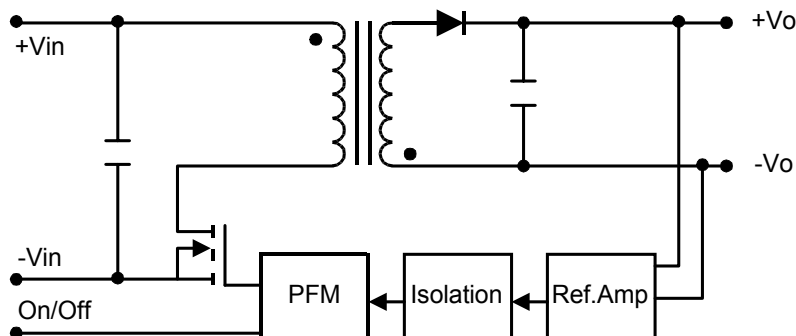

Model Selection Guide

Model Number	Input Voltage	Output Voltage	Output Current		Input Current		Efficiency
			Max.	Min.	@Max. Load	@No Load	
	VDC	VDC	mA	mA	mA (Typ.)	mA (Typ.)	% (Typ.)
MCW1011	5 (4.5 ~ 9)	3.3	500	125	471	40	70
MCW1012		5	400	100	548		73
MCW1013		12	167	42	534		75
MCW1021	12 (9 ~ 18)	3.3	500	125	184	20	73
MCW1022		5	400	100	217		77
MCW1023		12	167	42	209		80
MCW1031	24 (18 ~ 36)	3.3	500	125	96	10	72
MCW1032		5	400	100	109		77
MCW1033		12	167	42	103		81
MCW1041	48 (36 ~ 75)	3.3	500	125	49	8	71
MCW1042		5	400	100	57		73
MCW1043		12	167	42	53		79

Absolute Maximum Ratings

Parameter	Min.	Max.	Unit	
Input Surge Voltage (1000 mS)	5VDC Input Models	-0.7	15	VDC
	12VDC Input Models	-0.7	25	VDC
	24VDC Input Models	-0.7	50	VDC
	48VDC Input Models	-0.7	100	VDC
Lead Temperature (1.5mm from case for 10 Sec.)	---	260	°C	
Internal Power Dissipation	---	1,800	mW	

Exceeding these values can damage the module. These are not continuous operating ratings.

Environmental Specifications

Parameter	Conditions	Min.	Max.	Unit
Operating Temperature	Ambient	-40	+65	°C
Operating Temperature	Case	-40	+90	°C
Storage Temperature		-55	+105	°C
Humidity		---	95	%
Cooling	Free-Air Convection			

Note :

- Specifications typical at $T_a = +25^\circ\text{C}$, resistive load, nominal input voltage, rated output current unless otherwise noted.
- Transient recovery time is measured to within 1% error band for a step change in output load of 50% to 100%.
- Ripple & Noise measurement bandwidth is 0-20 MHz.
- These power converters require a minimum output loading to maintain specified regulation.
- Operation under no-load conditions will not damage these devices; however they may not meet all listed specifications.
- All DC/DC converters should be externally fused at the front end for protection.
- Other input and output voltage may be available, please contact factory.
- Specifications subject to change without notice.

MCW1000 Series

Input Specifications

Parameter	Model	Min.	Typ.	Max.	Unit
Start Voltage	5V Input Models	3.5	4	4.5	VDC
	12V Input Models	4.5	7	9	
	24V Input Models	8	12	18	
	48V Input Models	16	24	36	
Under Voltage Shutdown	5V Input Models	---	3.5	4	
	12V Input Models	---	6.5	8.5	
	24V Input Models	---	11	17	
	48V Input Models	---	22	34	
Reverse Polarity Input Current	All Models	---	---	1	A
Short Circuit Input Power		---	---	1500	mW
Input Filter		Capacitor type			

Output Specifications

Parameter	Conditions	Min.	Typ.	Max.	Unit
Output Voltage Accuracy		---	±1	±2	%
Line Regulation	V _{in} =Min. to Max.	---	±0.3	±0.5	%
Load Regulation	I _o =25% to 100%	---	±0.5	±0.75	%
Ripple & Noise (20MHz)		---	30	50	mV P-P
Ripple & Noise (20MHz)	Over Line, Load & Temp	---	---	75	mV P-P
Ripple & Noise (20MHz)		---	---	15	mV rms.
Over Power Protection		120	---	---	%
Transient Recovery Time	25% Load Step Change	---	100	300	µS
Transient Response Deviation		---	±3	±5	%
Temperature Coefficient		---	±0.01	±0.02	%/°C
Output Short Circuit	Continuous				

General Specifications

Parameter	Conditions	Min.	Typ.	Max.	Unit
Isolation Voltage	60 Seconds	1000	---	---	VDC
Isolation Test Voltage	Flash Tested for 1 Second	1100	---	---	VDC
Isolation Resistance	500VDC	1000	---	---	MΩ
Isolation Capacitance	100KHz, 1V	---	65	120	pF
Switching Frequency		100	300	650	KHz
MTBF	MIL-HDBK-217F @ 25°C, Ground Benign	1000	---	---	K Hours

Remote On/Off Control

Parameter	Conditions	Min.	Typ.	Max.	Unit
Supply On	under 1VDC or open circuit				
Supply Off		2.7	---	15	VDC
Device Standby Input Current		---	0.1	0.2	mA
Control Input Current (on)		---	---	-0.4	mA
Control Input Current (off)		---	---	1	mA
Control Common	Referenced to Negative Input				

MCW1000 Series

Capacitive Load

Models by Vout	3.3V	5V	12V	Unit
Maximum Capacitive Load	2200	1000	170	μF

Note: # For each output .

Input Fuse Selection Guide

5V Input Models	12V Input Models	24V Input Models	48V Input Models
1500mA Slow – Blow Type	700mA Slow – Blow Type	350mA Slow – Blow Type	135mA Slow – Blow Type

Input Voltage Transient Rating

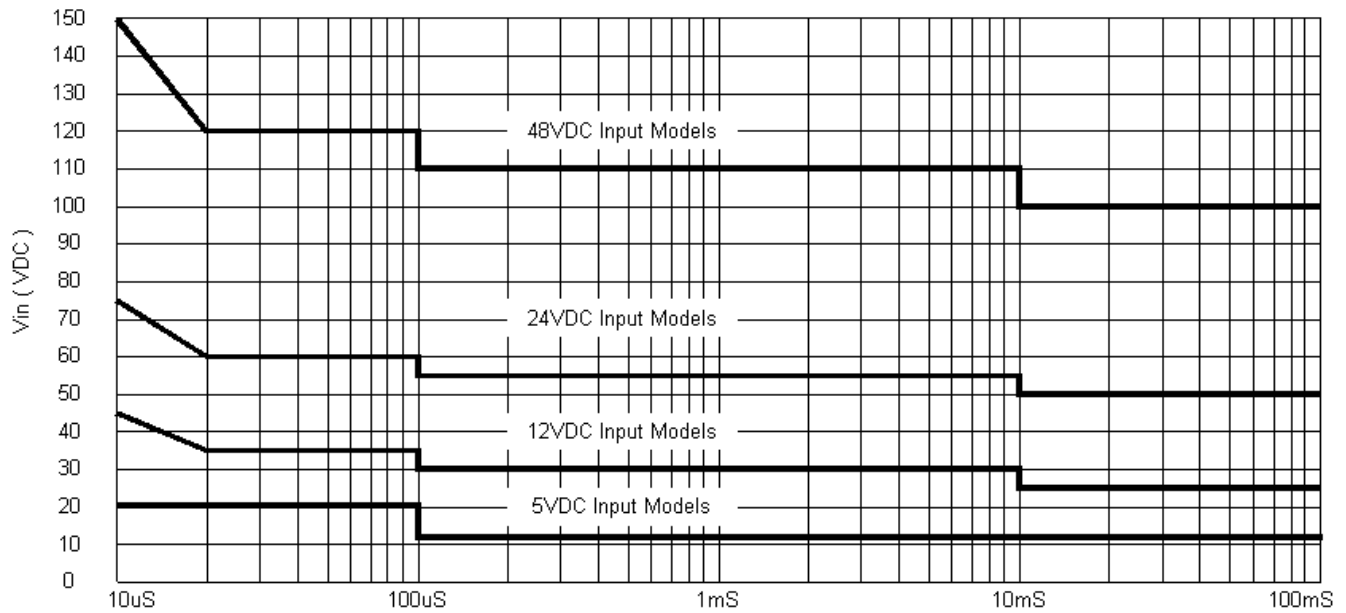

MCW1000 Series

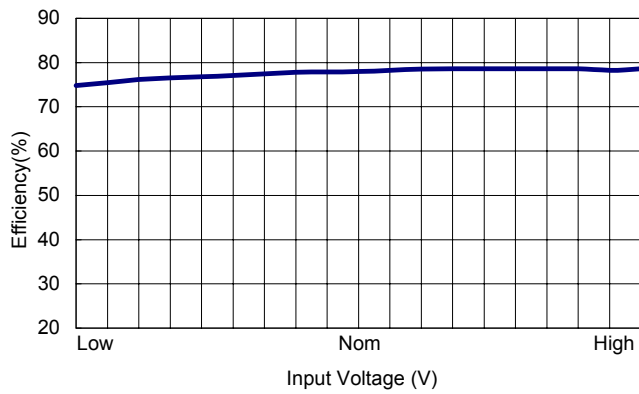

Efficiency vs Input Voltage (Single Output)

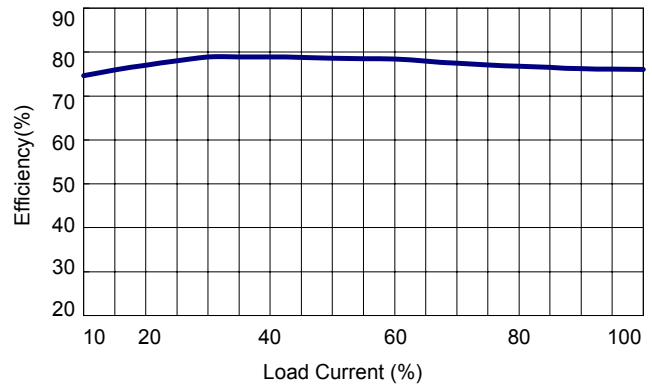

Efficiency vs Output Load (Single Output)

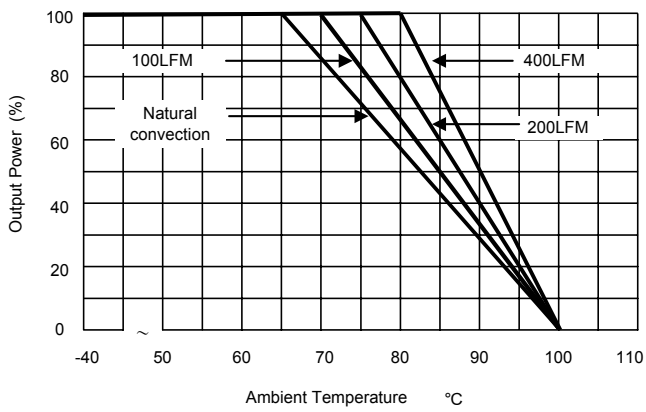

Derating Curve

Test Configurations

Input Reflected-Ripple Current Test Setup

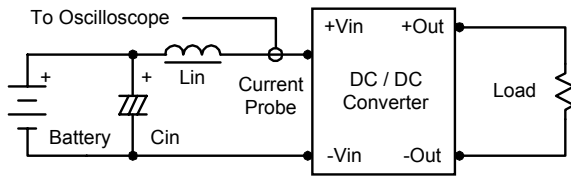

Input reflected-ripple current is measured with an inductor L_{in} (4.7 μ H) and C_{in} (220 μ F, ESR < 1.0 Ω at 100 KHz) to simulate source impedance.

Capacitor C_{in} , offsets possible battery impedance.

Current ripple is measured at the input terminals of the module, measurement bandwidth is 0–500 KHz.

Peak-to-Peak Output Noise Measurement Test

Use a C_{out} 0.47 μ F ceramic capacitor.

Scope measurement should be made by using a BNC socket, measurement bandwidth is 0–20 MHz. Position the load between 50 mm and 75 mm from the DC/DC Converter.

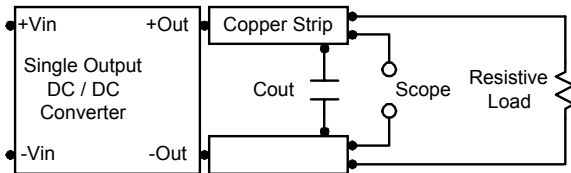

Design & Feature Considerations

Maximum Capacitive Load

The MCW1000 series has limitation of maximum connected capacitance at the output.

The power module may be operated in current limiting mode during start-up, affecting the ramp-up and the startup time.

The maximum capacitance can be found in the data.

Overcurrent Protection

To provide protection in a fault (output overload) condition, the unit is equipped with internal current limiting circuitry and can endure current limiting for an unlimited duration. At the point of current-limit inception, the unit shifts from voltage control to current control. The unit operates normally once the output current is brought back into its specified range.

Input Source Impedance

The power module should be connected to a low ac-impedance input source. Highly inductive source impedances can affect the stability of the power module.

In applications where power is supplied over long lines and output loading is high, it may be necessary to use a capacitor at the input to ensure startup.

Capacitor mounted close to the power module helps ensure stability of the unit, it is recommended to use a good quality low Equivalent Series Resistance (ESR < 1.0 Ω at 100 KHz) capacitor of a 8.2 μ F for the 5V input devices, a 3.3 μ F for the 12V input devices and a 1.5 μ F for the 24V and 48V devices.

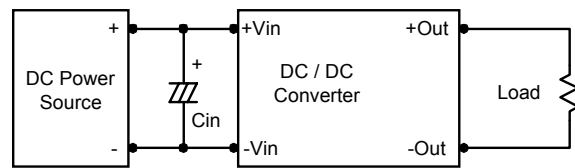

Output Ripple Reduction

A good quality low ESR capacitor placed as close as practicable across the load will give the best ripple and noise performance.

To reduce output ripple, it is recommended to use 3.3 μ F capacitors at the output.

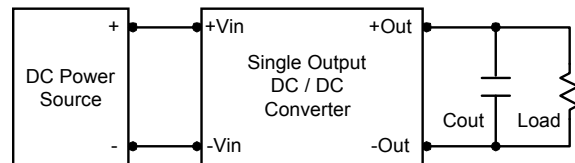

MCW1000 Series

Thermal Considerations

Many conditions affect the thermal performance of the power module, such as orientation, airflow over the module and board spacing. To avoid exceeding the maximum temperature rating of the components inside the power module, the case temperature must be kept below 90°C.

The derating curves are determined from measurements obtained in an experimental apparatus.

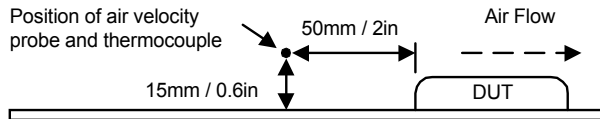

Mechanical Data

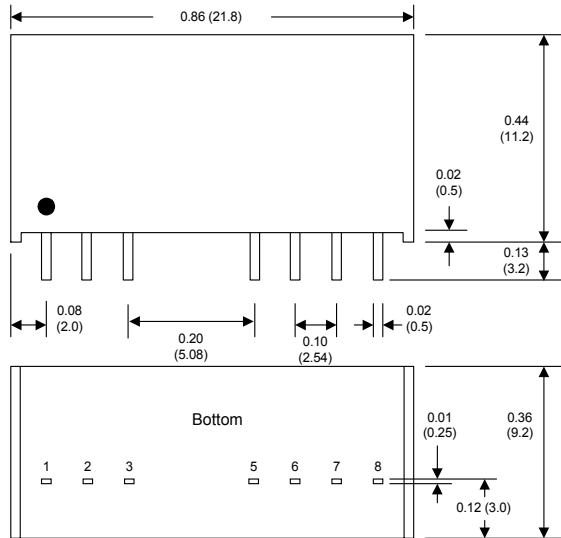

Connecting Pin Patterns

Top View (2.54 mm / 0.1 inch grids)

Single Output

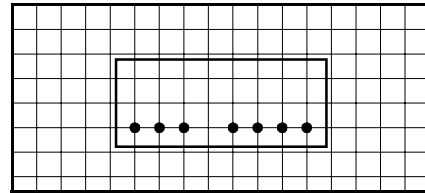

Tolerance	Millimeters	Inches
	.X±0.25	.XX±0.01
	.XX±0.25	.XXX±0.01
Pin	±0.05	±0.002

Pin Connections

Pin	Single Output
1	-Vin(GND)
2	+Vin(VCC)
3	Remote ON/OFF
5	No function
6	+Vout
7	-Vout
8	No function

NC: No Connection

Physical Characteristics

Case Size	: 21.8×9.3×11.1mm 0.86×0.37×0.44inches
Case Material	: Non-Conductive Black Plastic
Weight	: 4.8g
Flammability	: UL94V-0

Units are encapsulated in a low thermal resistance molding compound which has excellent chemical resistance and electrical properties in high humidity environment and over a wide operating temperature range. The encapsulant and outer shell of the unit have UL94V-0 ratings. The leads are tin plated for better soldering.