

## Ku Band 2 Watt Packaged Amplifier

## TGA2510-EPU-SG



### Key Features and Performance

- 33.5 dBm Midband Psat
- 25 dB Nominal Gain
- 7 dB Typical Input Return Loss
- 10 dB Typical Output Return Loss
- 12.5 - 17 GHz Frequency Range
- Directional Power Detector with Reference
- 0.25 $\mu$ m pHEMT 3MI Technology
- Bias Conditions: 7.5V, 650mA
- Package Dimensions:  
9.4 x 6.4 x 1.8 mm  
(0.370 x 0.250 x 0.071 inches)

### Preliminary Measured Performance

Bias Conditions: Vd=7.5V Id=650mA

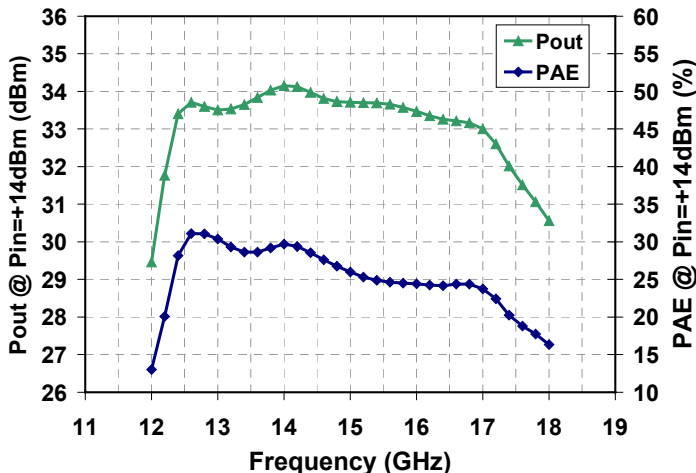
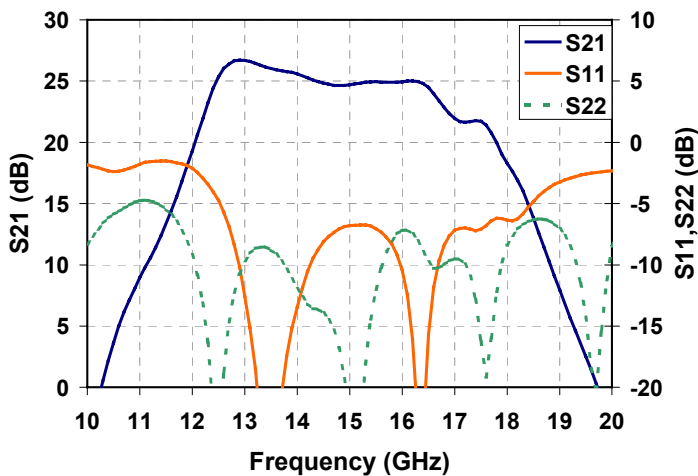

Note: Devices designated as EPU are typically early in their characterization process prior to finalizing all electrical and process specifications. Specifications are subject to change without notice.

### Primary Applications

- VSAT
- Point to Point

**TABLE I  
MAXIMUM RATINGS**

Symbol	Parameter	Value	Notes
$V_D$	Drain Voltage	8 V	<u>1/</u> <u>2/</u>
$V_G$	Gate Voltage Range	-5V to 0V	<u>1/</u>
$I_D$	Drain Supply Current (Quiescent)	1300 mA	<u>1/</u> <u>2/</u>
$ I_G $	Gate Supply Current	18 mA	<u>1/</u>
$P_{IN}$	Input Continuous Wave Power	24 dBm	<u>1/</u> <u>2/</u>
$P_D$	Power Dissipation	6.15 W	<u>1/</u> <u>2/</u> <u>3/</u>
$T_{CH}$	Operating Channel Temperature	150 °C	<u>4/</u>
$T_M$	Mounting Temperature (30 Seconds)	320 °C	
$T_{STG}$	Storage Temperature	-65 to 150 °C	

- 1/ These ratings represent the maximum operable values for this device
- 2/ Combinations of supply voltage, supply current, input power, and output power shall not exceed  $P_D$  at a package base temperature of 70°C
- 3/ When operated at this bias condition with a baseplate temperature of 70°C, the MTTF is reduced to 1.0E+6 hours
- 4/ Junction operating temperature will directly affect the device median time to failure (MTTF). For maximum life, it is recommended that junction temperatures be maintained at the lowest possible levels.

**TABLE II  
THERMAL INFORMATION**

Parameter	Test Conditions	$T_{CH}$ (°C)	$R_{\theta JC}$ (°C/W)	MTTF (hrs)
$R_{\theta JC}$ Thermal Resistance (Channel to Backside of Package)	$V_D = 7.5V$ $I_D = 650mA$ $P_{DISS} = 4.88W$ $T_{BASE} = 70^\circ C$	132.3	12.8	4.8E+6

Note: Devices designated as EPU are typically early in their characterization process prior to finalizing all electrical and process specifications. Specifications are subject to change without notice.

**TABLE III**  
**RF CHARACTERIZATION TABLE**  
( $T_A = 25^\circ\text{C}$ , Nominal)  
( $V_d = 7.5\text{V}$ ,  $I_d = 650\text{mA} \pm 5\%$ )

Symbol	Parameter	Test Conditions	Typ	Units	Notes
Gain	Small Signal Gain	F = 12.5 – 16 GHz	25	dB	
IRL	Input Return Loss	F = 12.5 – 16 GHz	7	dB	
ORL	Output Return Loss	F = 12.5 – 16 GHz	10	dB	
PWR	Output Power @ Pin = +14dBm	F = 12.5 – 16 GHz	33.5	dBm	
PAE	Power Added Efficiency @ Pin = +14dBm	F = 12.5 – 16 GHz	29	%	

Note: Table III Lists the RF Characteristics of typical devices as determined by fixtured measurements.

*Note: Devices designated as EPU are typically early in their characterization process prior to finalizing all electrical and process specifications. Specifications are subject to change without notice.*

Typical Fixtured Performance **TGA2510-EPU-SG**

**$I_d=650\text{mA}$**

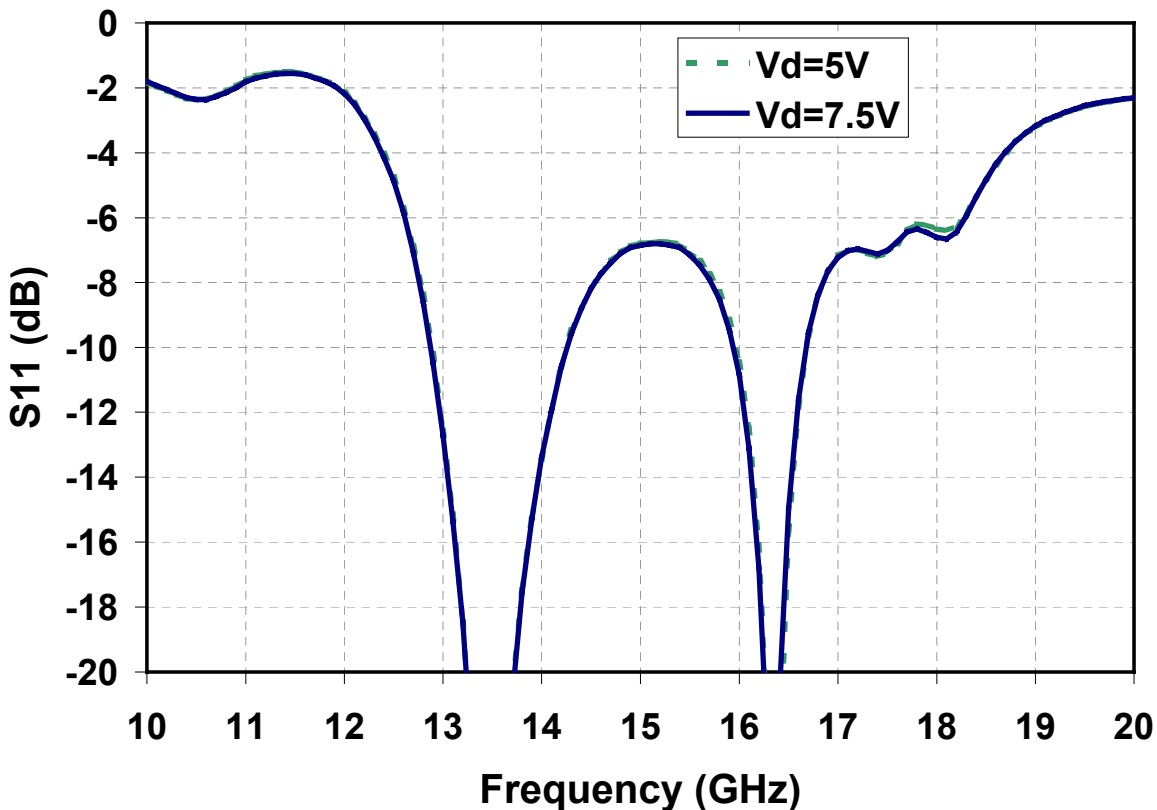
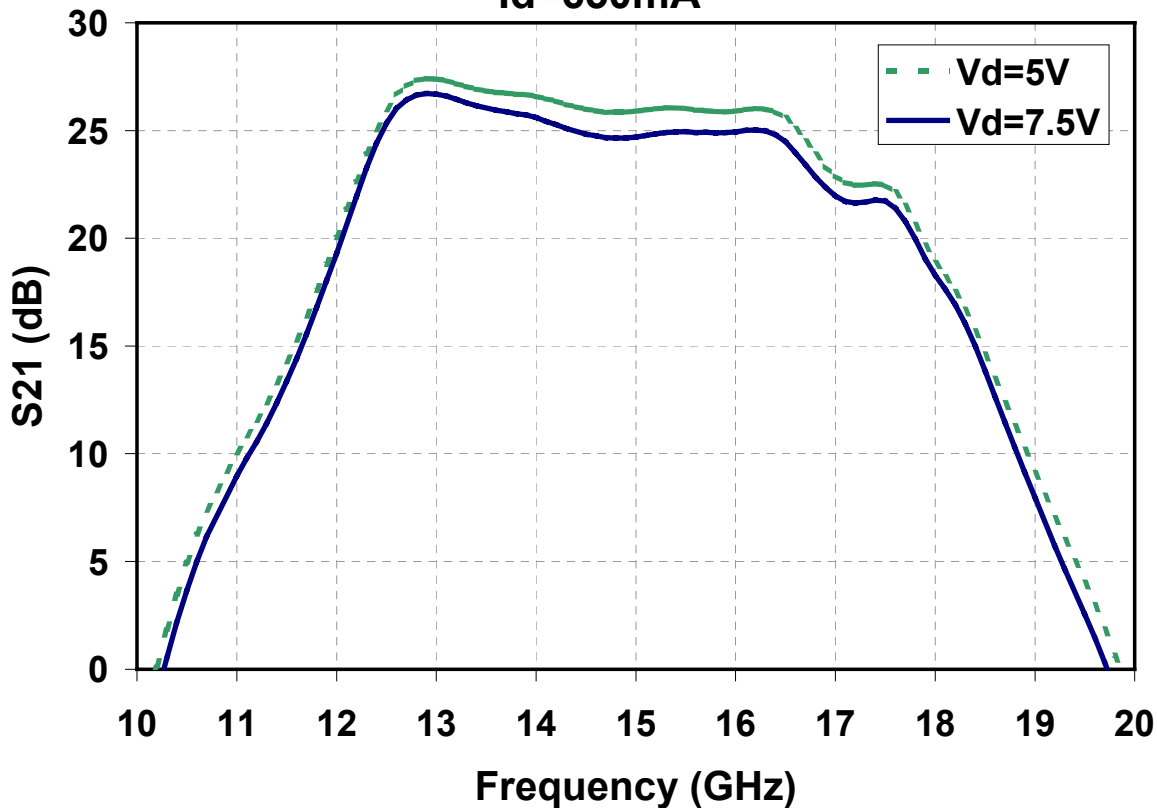

Note: Devices designated as EPU are typically early in their characterization process prior to finalizing all electrical and process specifications. Specifications are subject to change without notice.

Typical Fixtured Performance **TGA2510-EPU-SG**

**$I_d=650\text{mA}$**

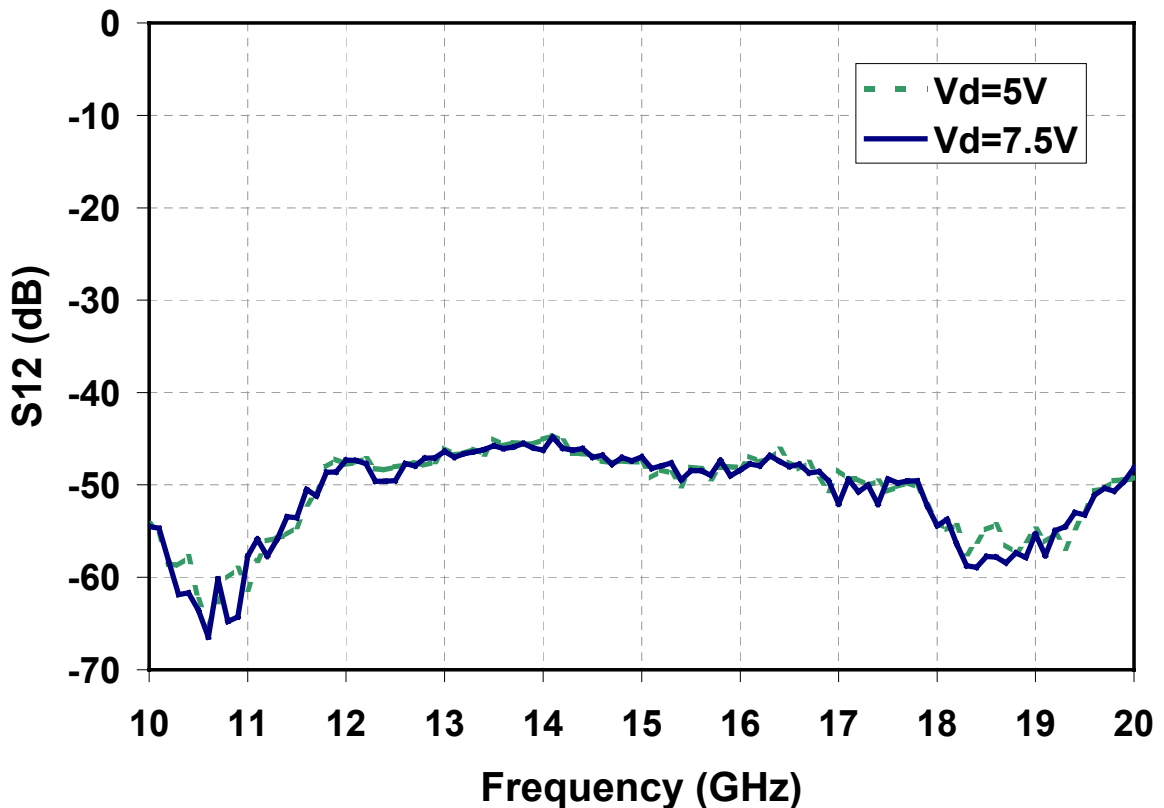
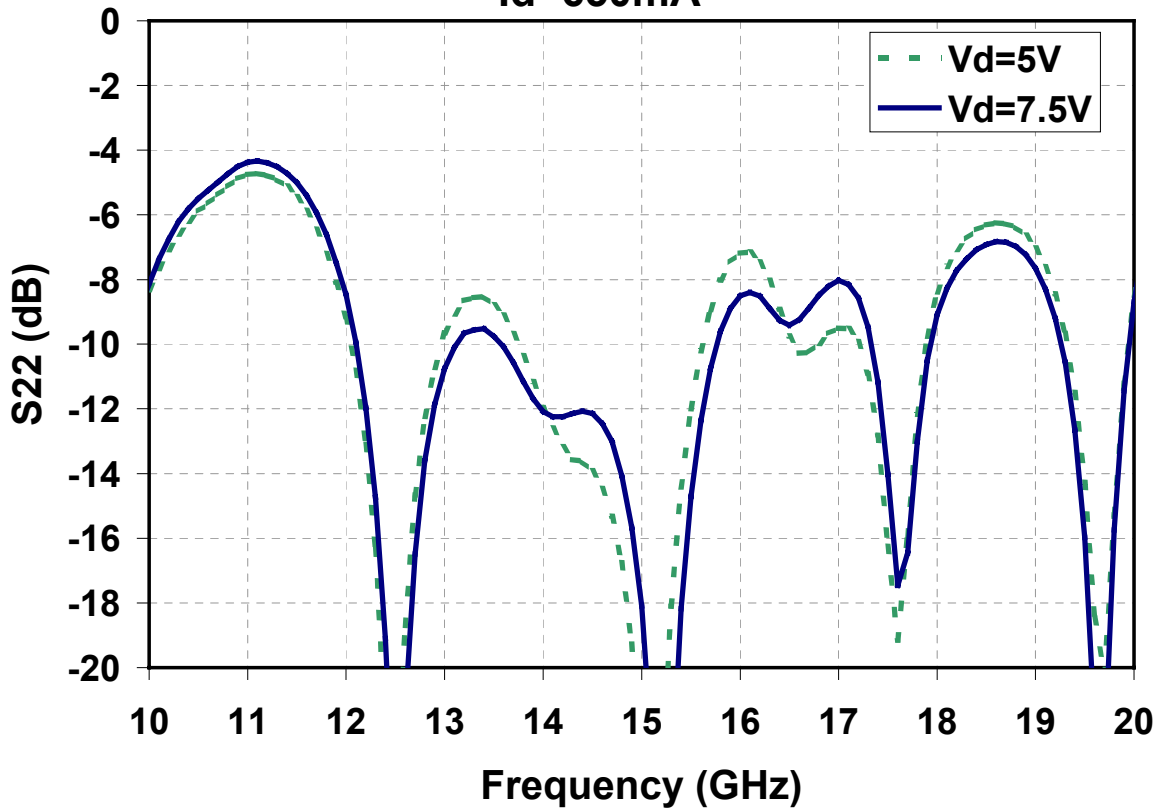

Note: Devices designated as EPU are typically early in their characterization process prior to finalizing all electrical and process specifications. Specifications are subject to change without notice.

**Typical Fixtured Performance**  
**Id=650mA**

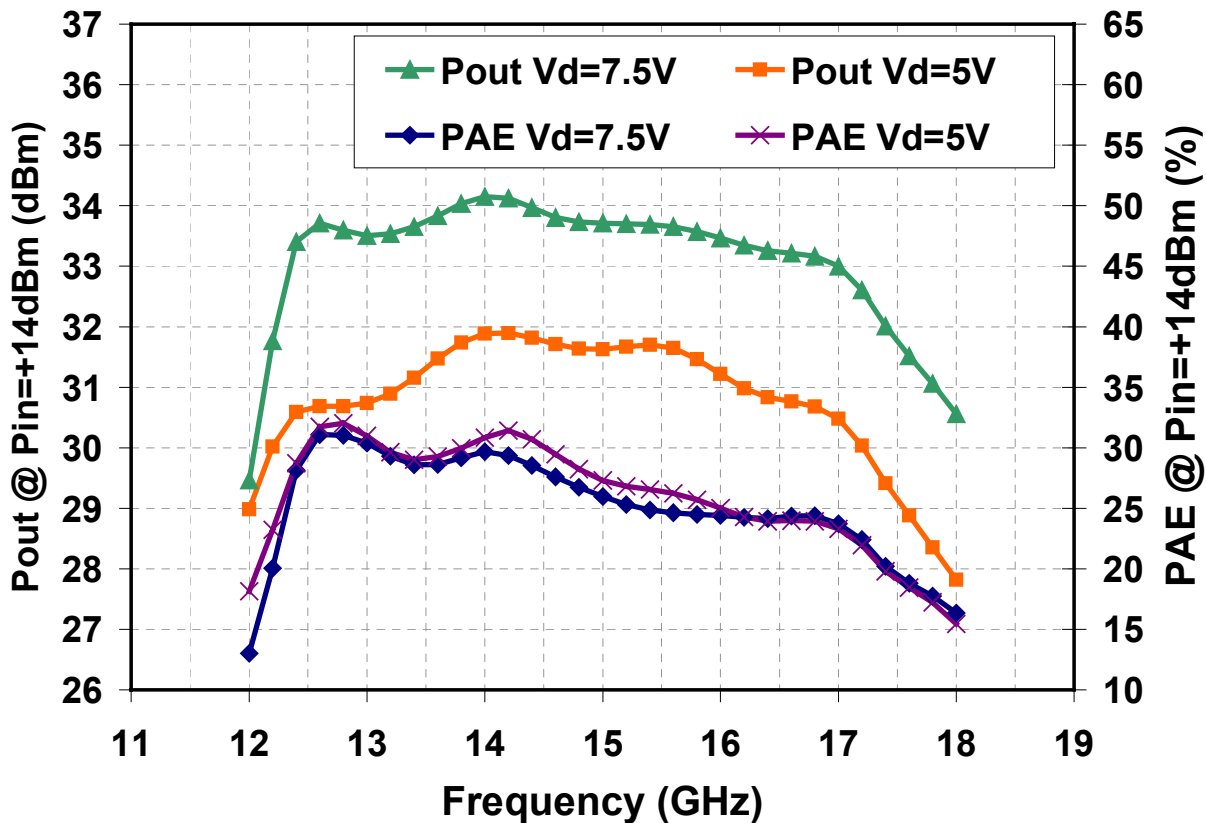

Note: Devices designated as EPU are typically early in their characterization process prior to finalizing all electrical and process specifications. Specifications are subject to change without notice.

Typical Fixtured Performance **TGA2510-EPU-SG**

**Id=800mA**

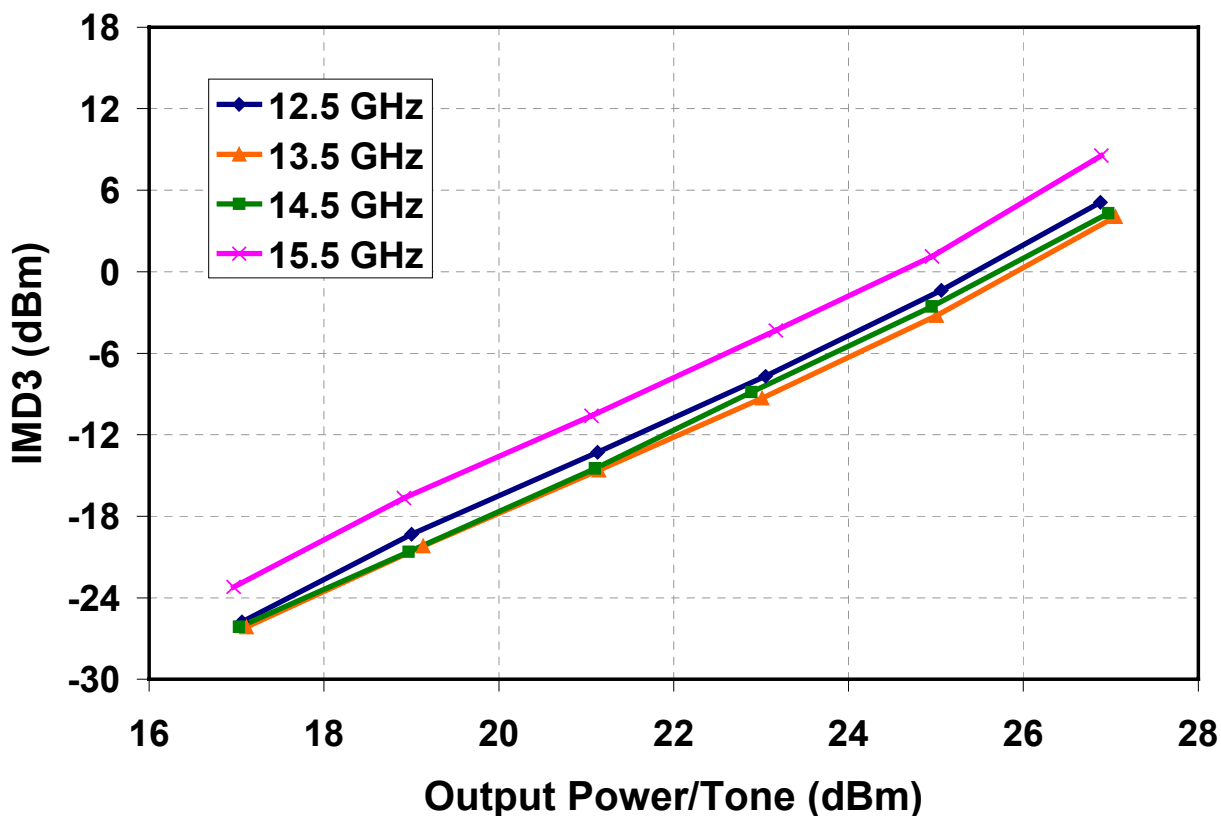
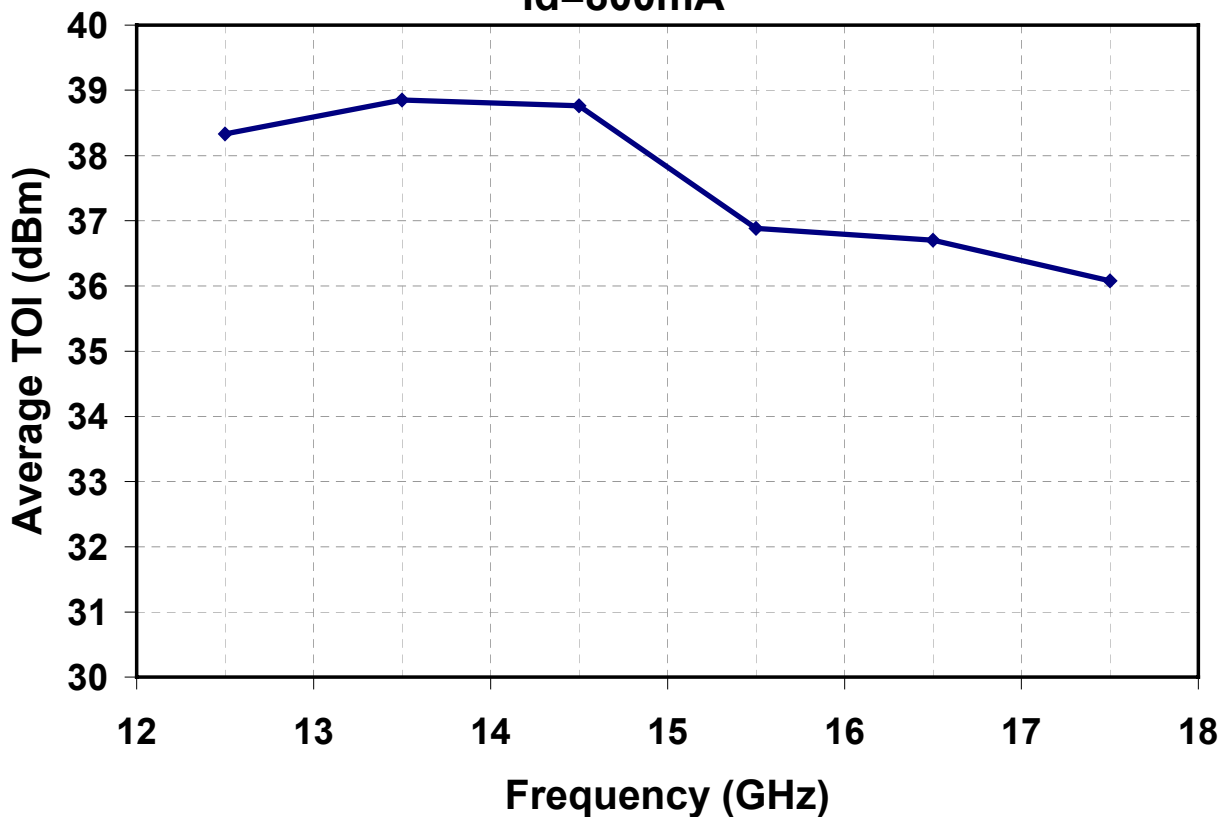

Note: Devices designated as EPU are typically early in their characterization process prior to finalizing all electrical and process specifications. Specifications are subject to change without notice.

**Package Pinout Diagram**

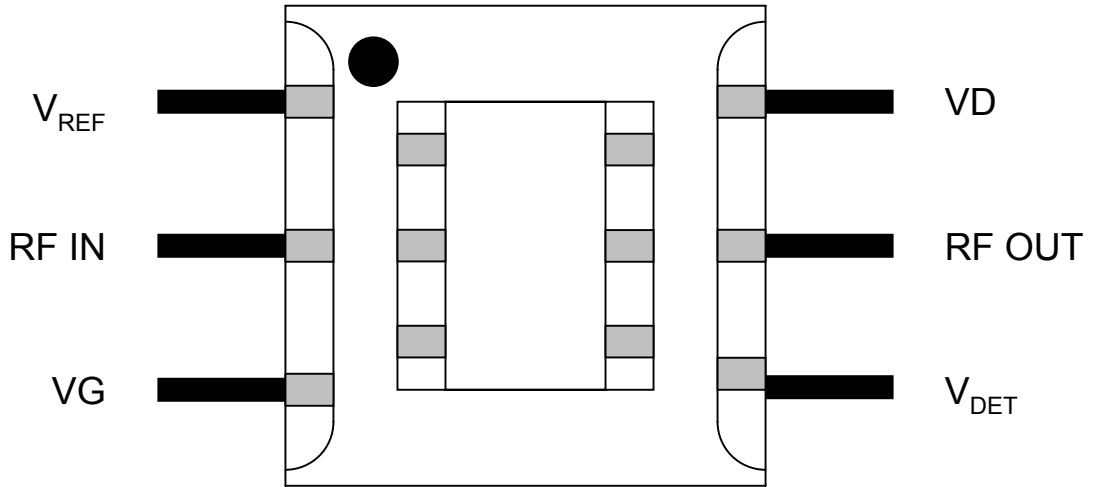

**Package Assembly Diagram**

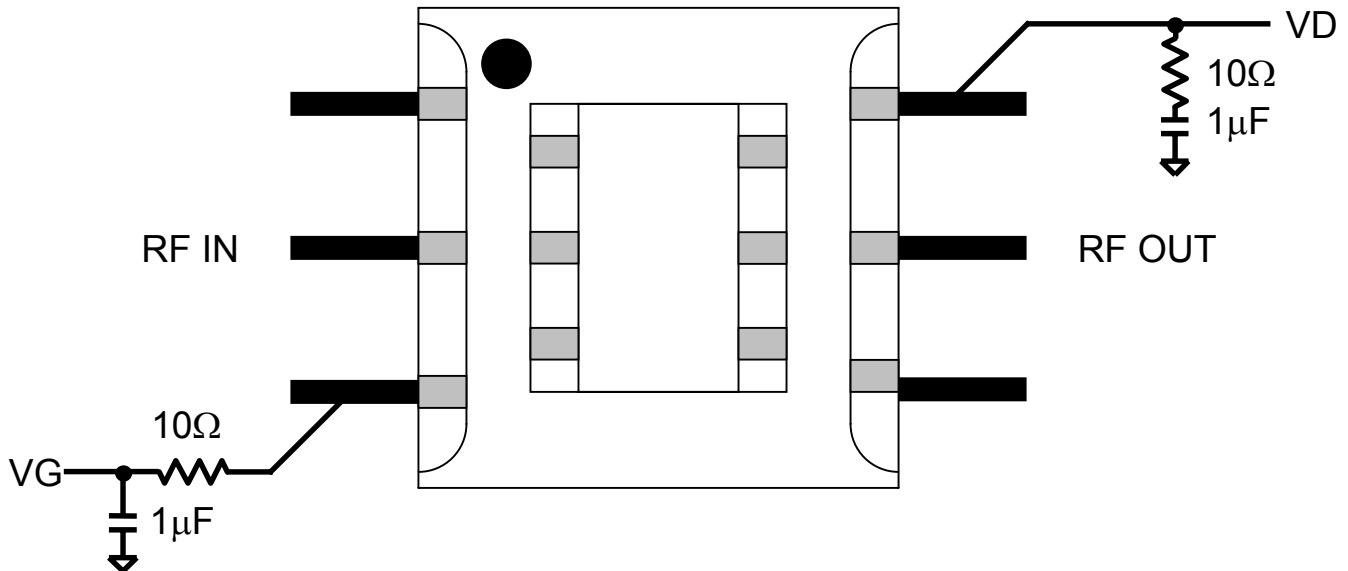

**GaAs MMIC devices are susceptible to damage from Electrostatic Discharge. Proper precautions should be observed during handling, assembly and test.**

*Note: Devices designated as EPU are typically early in their characterization process prior to finalizing all electrical and process specifications. Specifications are subject to change without notice.*



**Mechanical Drawing**

Dimensions in inches

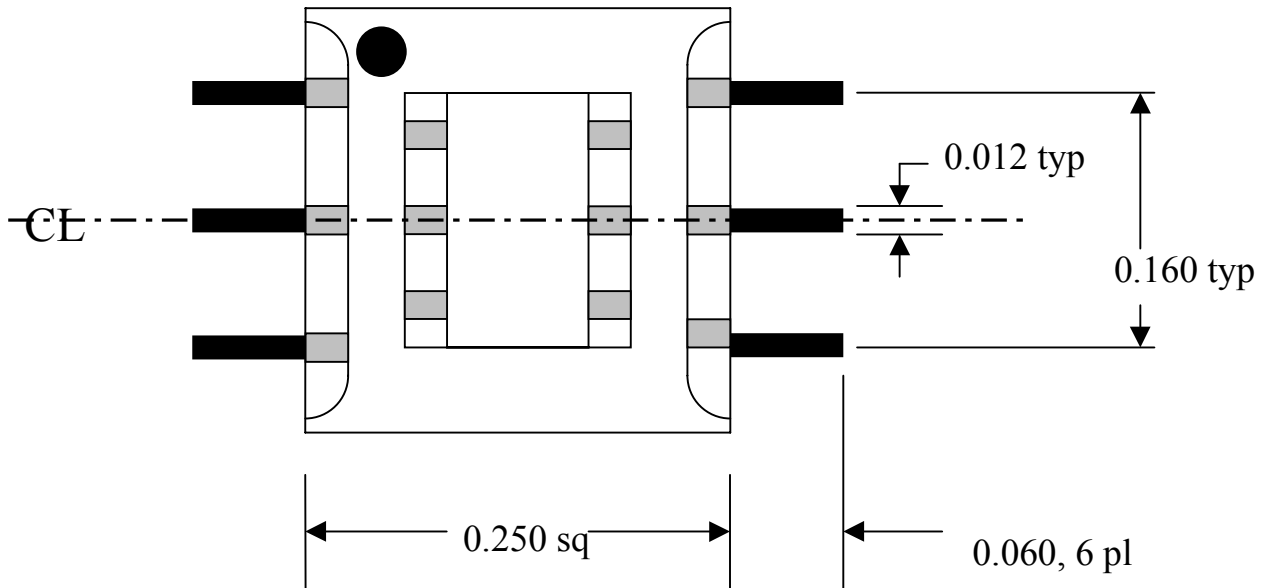

**Top View**

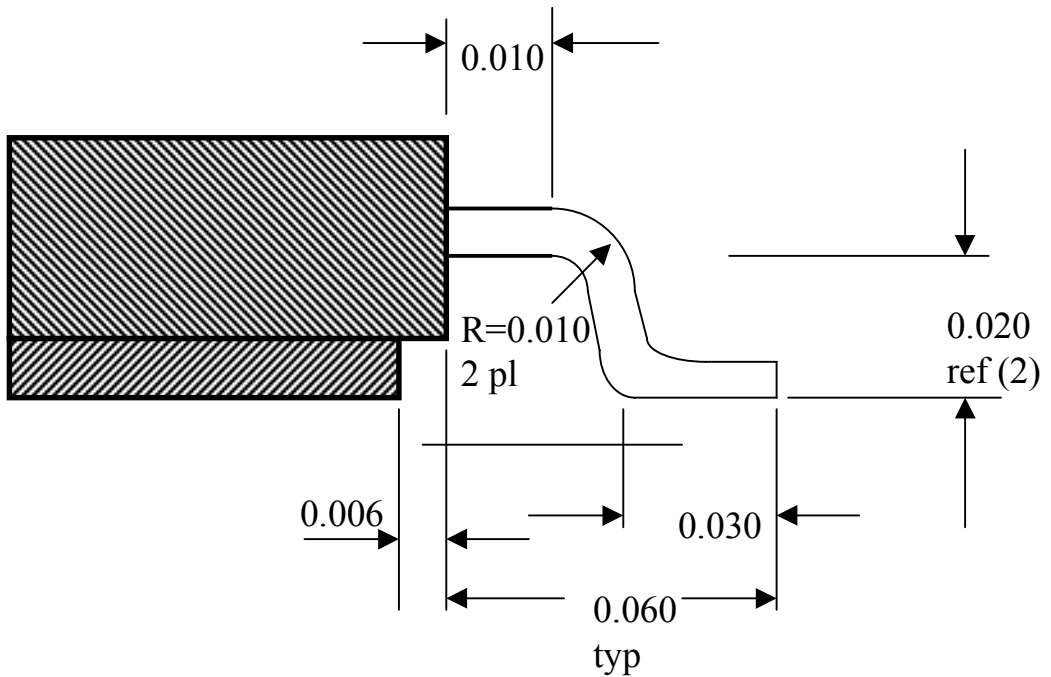

**Side View**

*Note: Devices designated as EPU are typically early in their characterization process prior to finalizing all electrical and process specifications. Specifications are subject to change without notice.*

**Recommended PWB Land Pattern**

Dimensions in inches

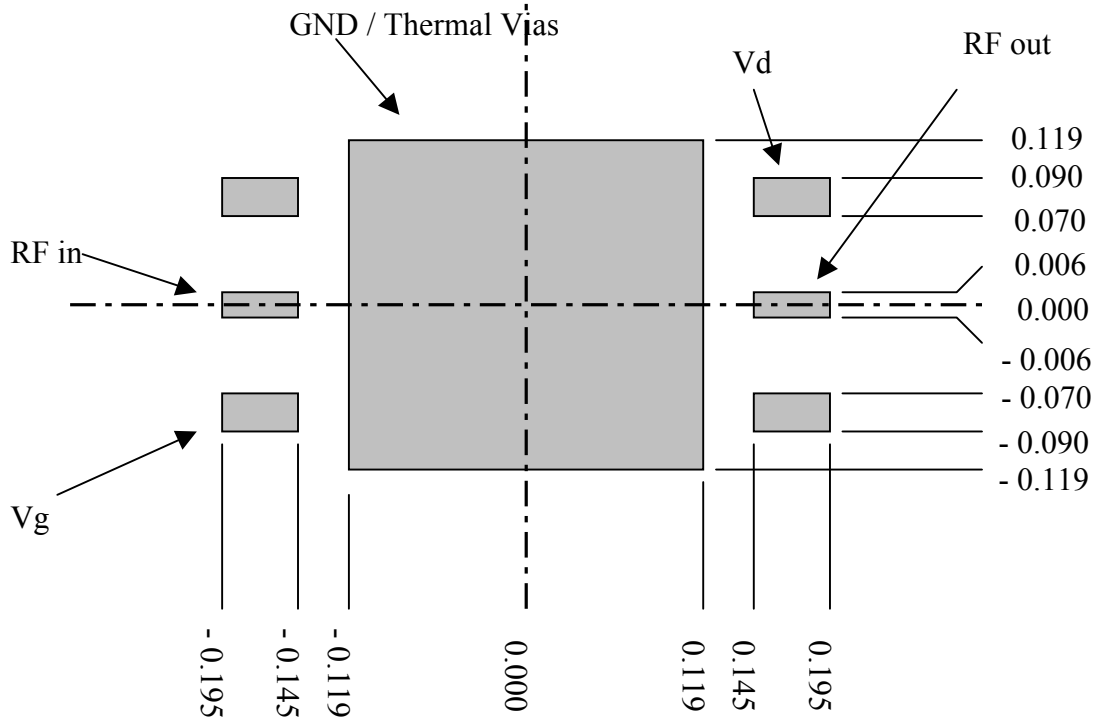

*Note: Devices designated as EPU are typically early in their characterization process prior to finalizing all electrical and process specifications. Specifications are subject to change without notice.*

**Power Detector**

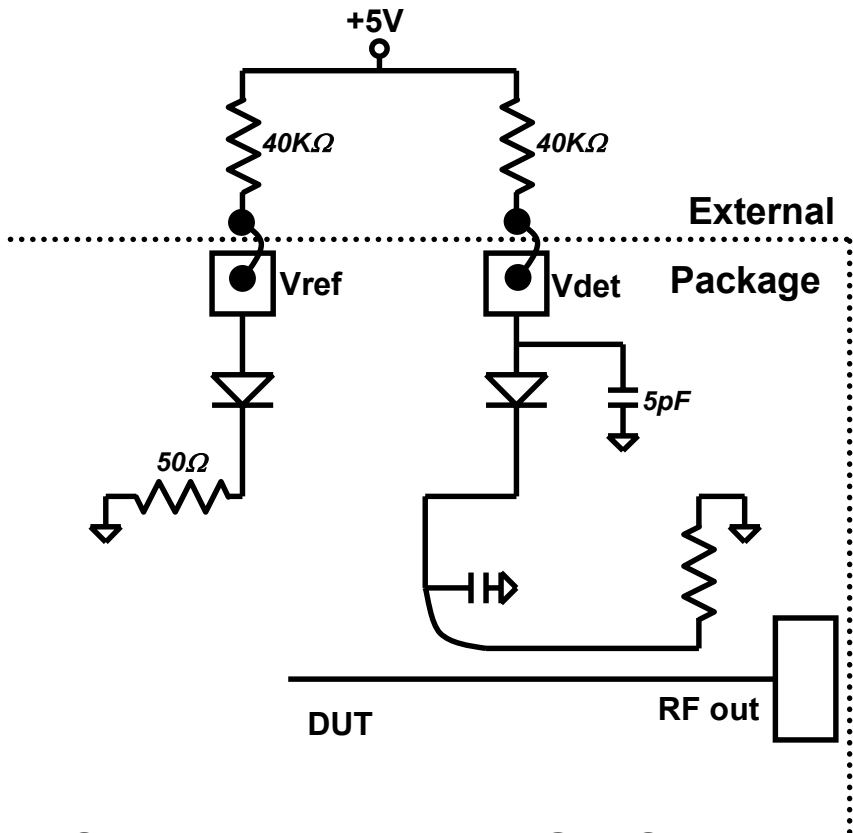

**TGA2510 Power Detector @ 14GHz**

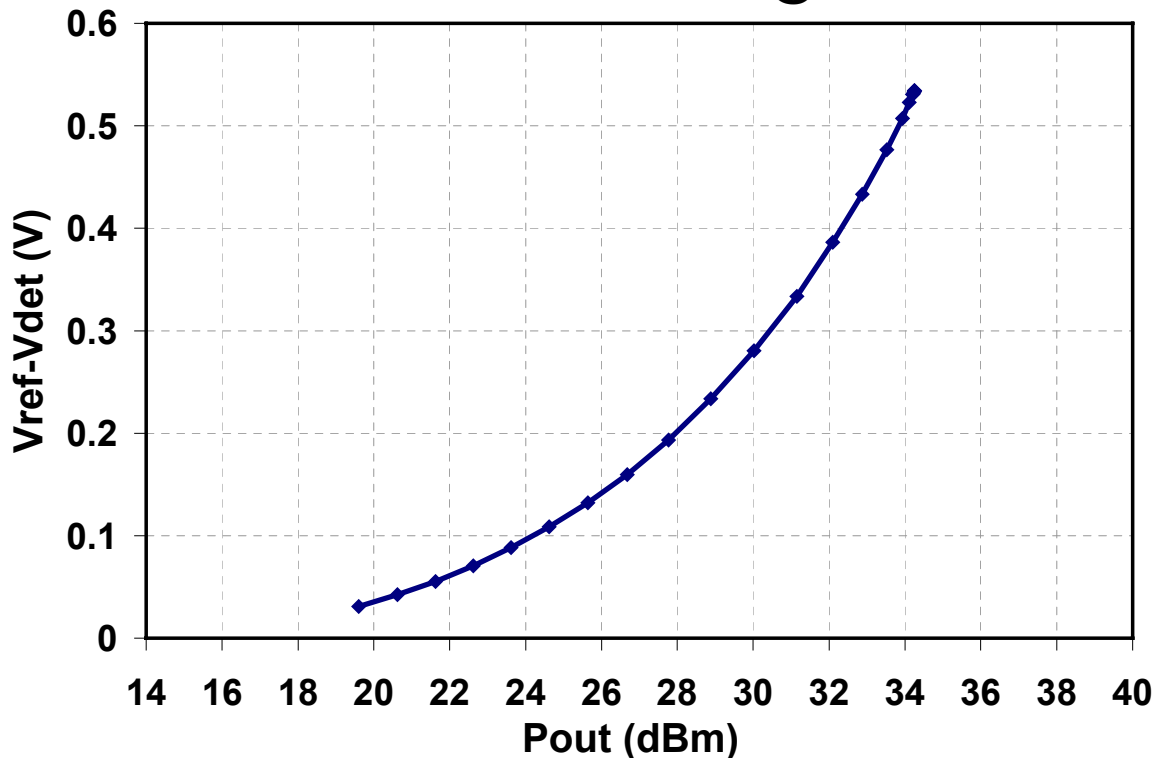

Note: Devices designated as EPU are typically early in their characterization process prior to finalizing all electrical and process specifications. Specifications are subject to change without notice.