

Ku Band 2W Packaged Amplifier

TGA8658-EPU-SG

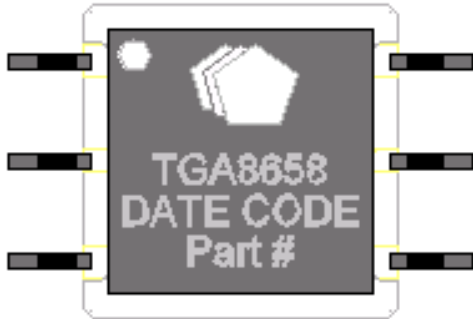

Package Dimensions 6.4 x 6.4 x 3.0 mm

Key Features

- Frequency Range: 13-17 GHz
- Optimized for VSAT band (13.75-14.5GHz)
- 33 dB Nominal Gain
- Typical > 33.5 dBm Psat in VSAT band @ 7V
- Bias 5-8 V @ 680 mA (Quiescent)
- 0.5 μm 3MI pHEMT Technology
- Integrated power detector
- 6 lead package
- Package Dimensions: 6.4 x 6.4 x 3.0 mm (0.3 x 0.3 x 0.1 in)

Primary Applications

- VSAT
- Point-to-Point

Fixtured Measured Performance

Bias Conditions: Vd = 7 V, Idq = 680 mA

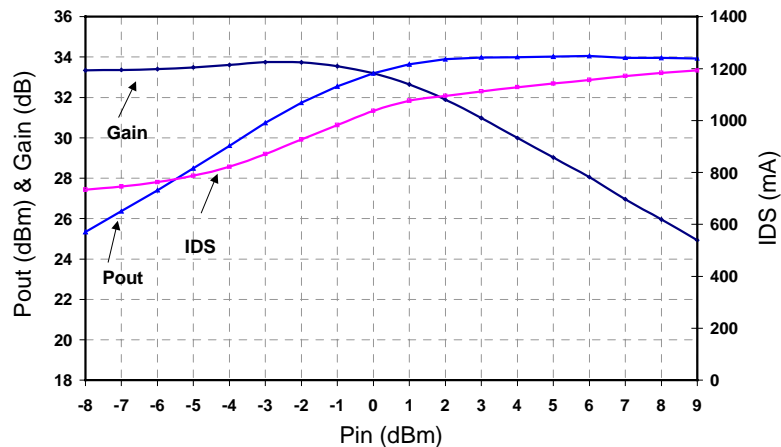
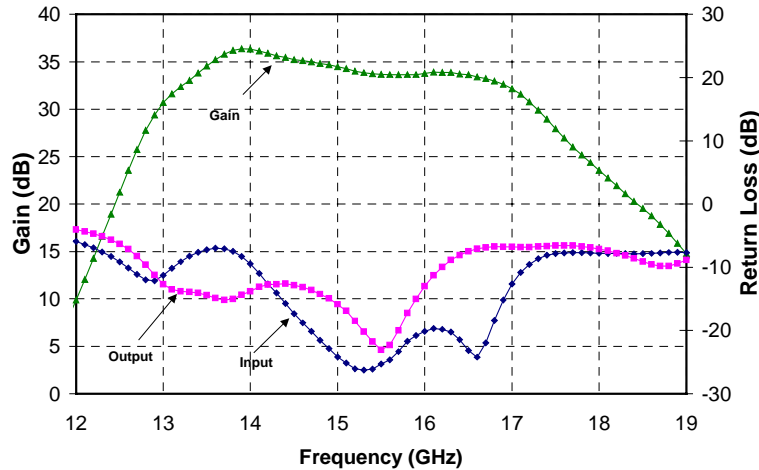

Data taken @ 14.5 GHz

Note: Devices designated as EPU are typically early in their characterization process prior to finalizing all electrical and process specifications. Specifications are subject to change without notice.

TABLE I
MAXIMUM RATINGS 1/

Symbol	Parameter	Value	Notes
V _d	Drain Supply Voltage	8 V	<u>2/</u>
V _g	Gate Supply Voltage Range	-5V to 0V	
I _{dq}	Drain Supply Current (Quiescent)	1.3 A	<u>2/</u>
I _g	Gate Current	18 mA	
P _{IN}	Input Continuous Wave Power	21 dBm	<u>2/</u>
P _D	Power Dissipation	5 W + (85°C- T _B)/13	<u>2/ 3/</u>
T _{CH}	Operating Channel Temperature	150 °C	<u>4/ 5/</u>
T _M	Mounting Temperature (30 Seconds)	320 °C	
T _{STG}	Storage Temperature	-65 to 150 °C	

1/ These ratings represent the maximum operable values for this device.

2/ Combinations of supply voltage, supply current, input power, and output power shall not exceed P_D.

3/ T_B = Package backside temperature in degrees C.

4/ These ratings apply to each individual FET.

5/ Junction operating temperature will directly affect the device median time to failure (T_M). For maximum life, it is recommended that junction temperatures be maintained at the lowest possible levels.

TABLE II
RF CHARACTERIZATION TABLE
(T_A = 25°C, Nominal)
(V_d = 7 V, I_{dq} = 680 mA)

SYMBOL	PARAMETER	TEST CONDITION	TYPICAL	UNITS
Gain	Small Signal Gain	F = 13 –17 GHz	33	dB
IRL	Input Return Loss	F = 13 –17 GHz	10	dB
ORL	Output Return Loss	F = 13 –17 GHz	10	dB
PWR	Output Power @ Pin = +5 dBm	F = 13 –15 GHz	34	dBm

Note: Devices designated as EPU are typically early in their characterization process prior to finalizing all electrical and process specifications. Specifications are subject to change without notice.

Measured Fixtured Data

Bias Conditions: $V_d = 7\text{ V}$, $I_{dq} = 680\text{ mA}$

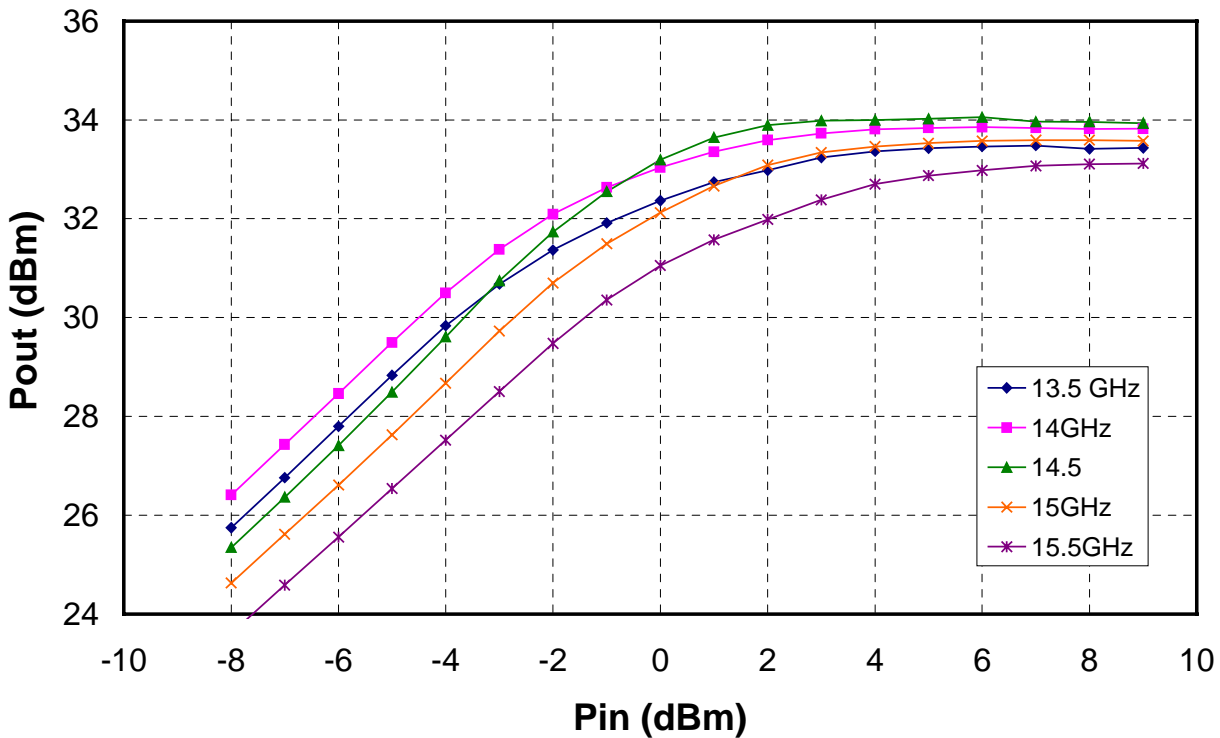
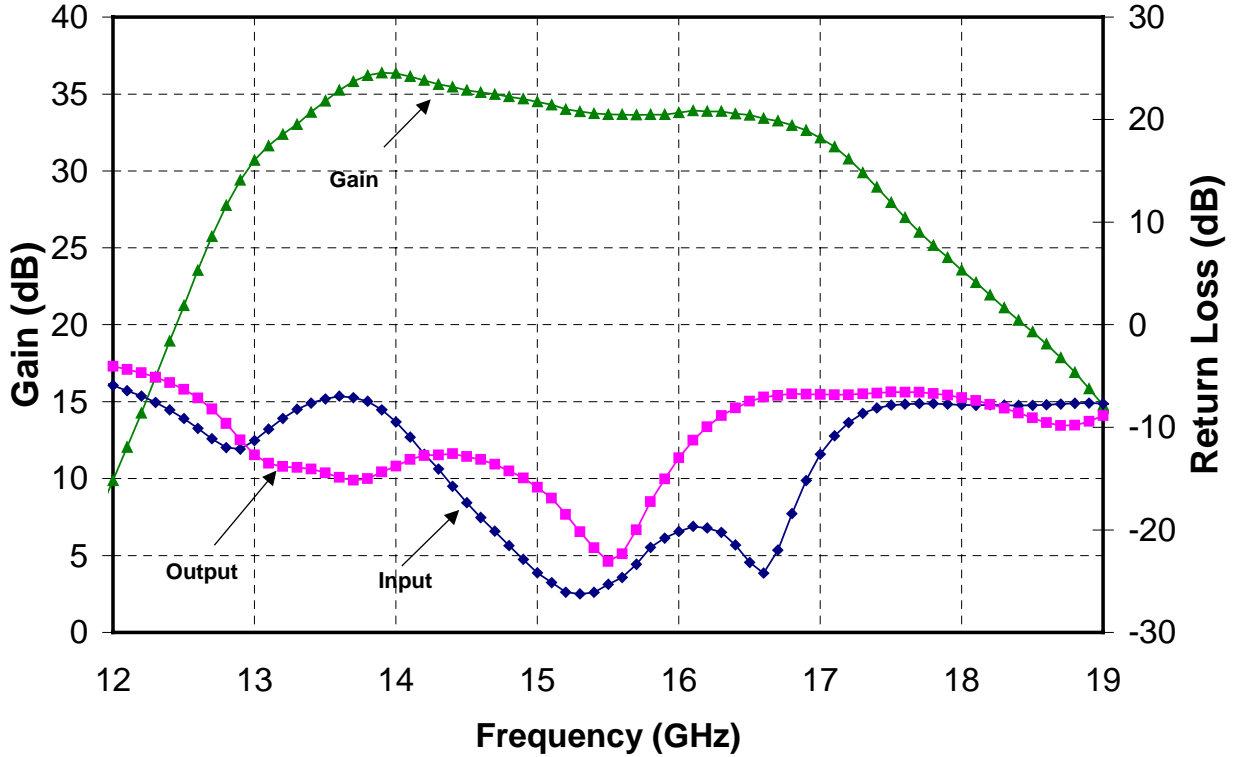

Note: Devices designated as EPU are typically early in their characterization process prior to finalizing all electrical and process specifications. Specifications are subject to change without notice.

Measured Fixtured Data

Bias Conditions: $V_d = 7\text{ V}$, $I_{dq} = 680\text{ mA}$

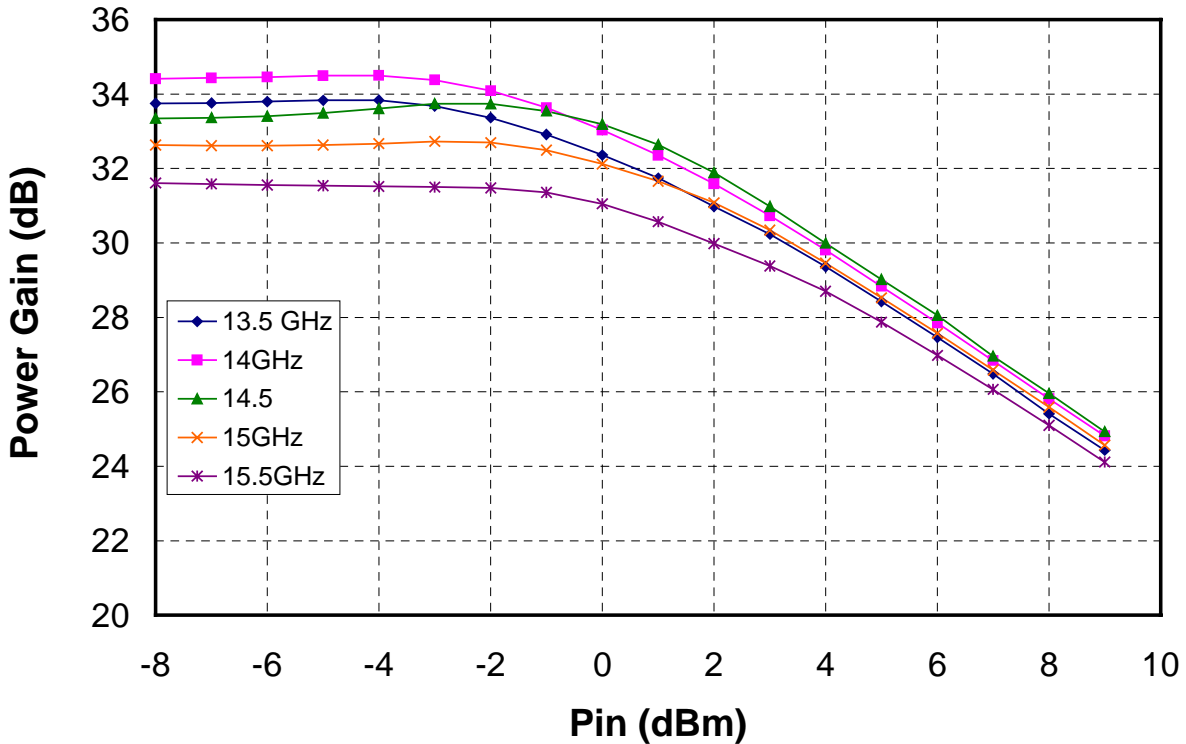
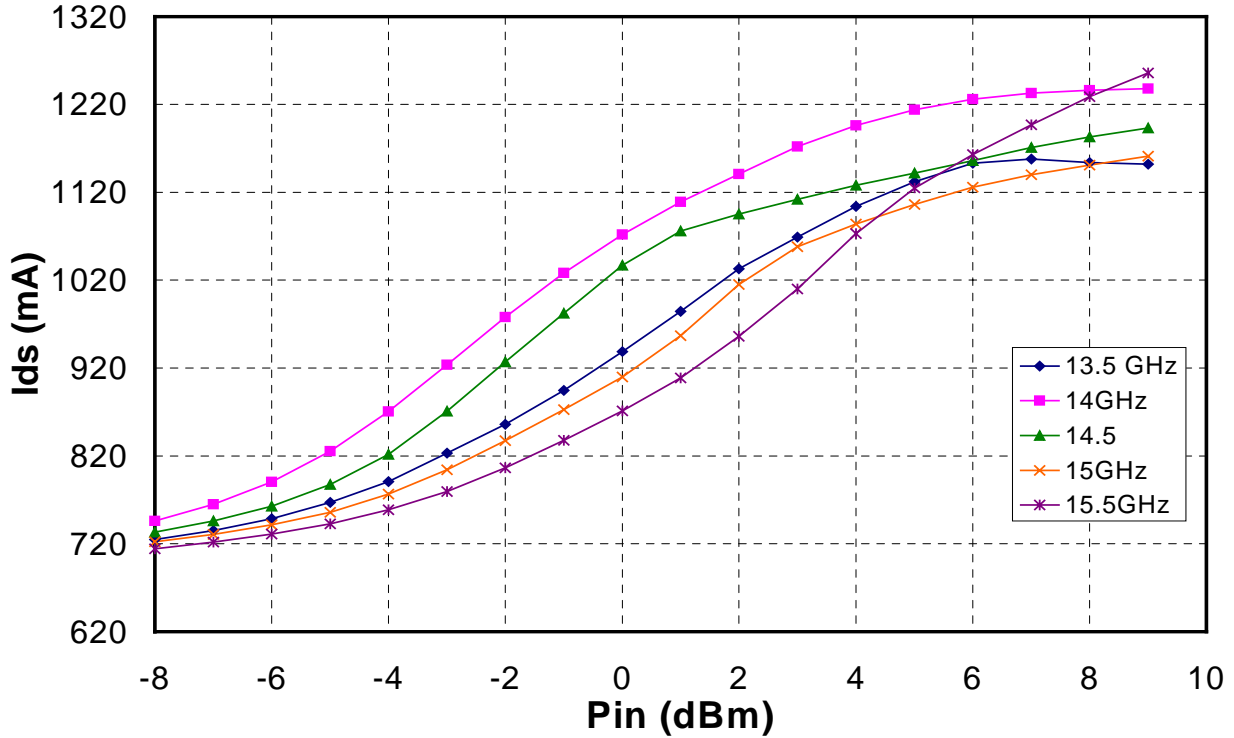

Note: Devices designated as EPU are typically early in their characterization process prior to finalizing all electrical and process specifications. Specifications are subject to change without notice.

Measured Fixtured Data

Bias Conditions: $V_d = 7\text{ V}$, $I_{dq} = 680\text{ mA}$

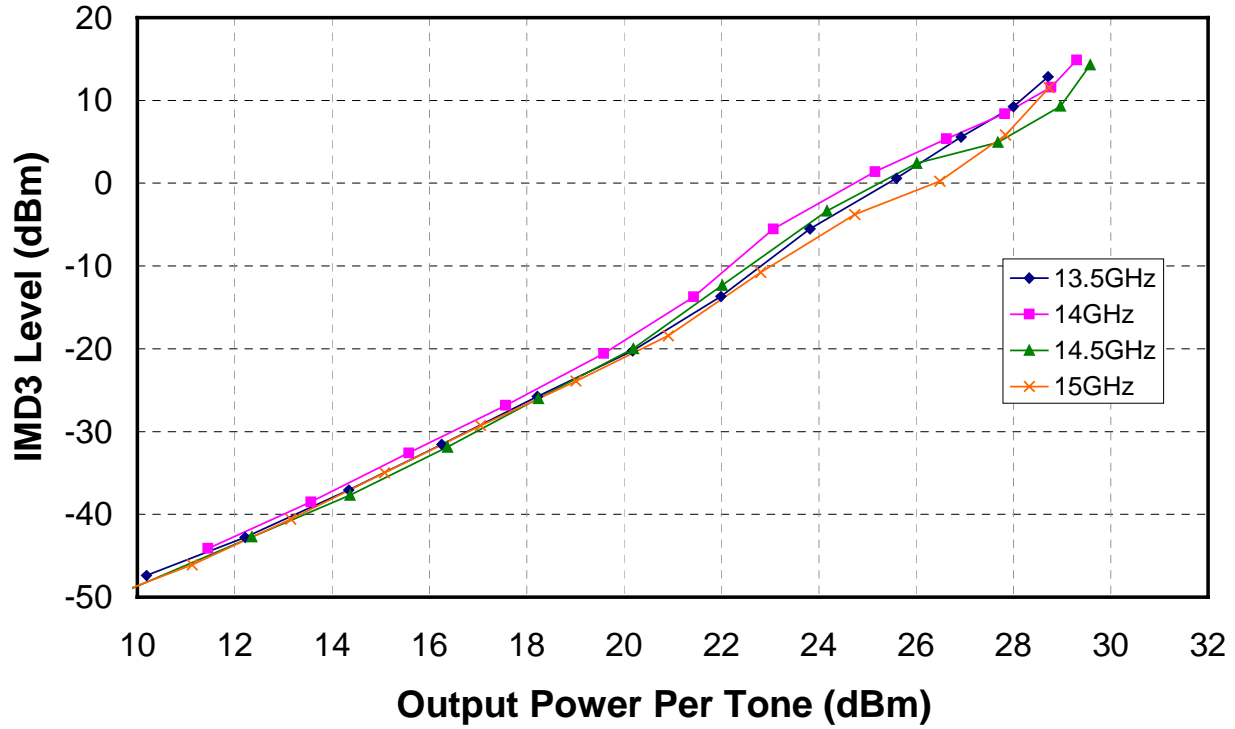

Note: Devices designated as EPU are typically early in their characterization process prior to finalizing all electrical and process specifications. Specifications are subject to change without notice.

Packaged Dimensional Drawing TGA8658 - SG

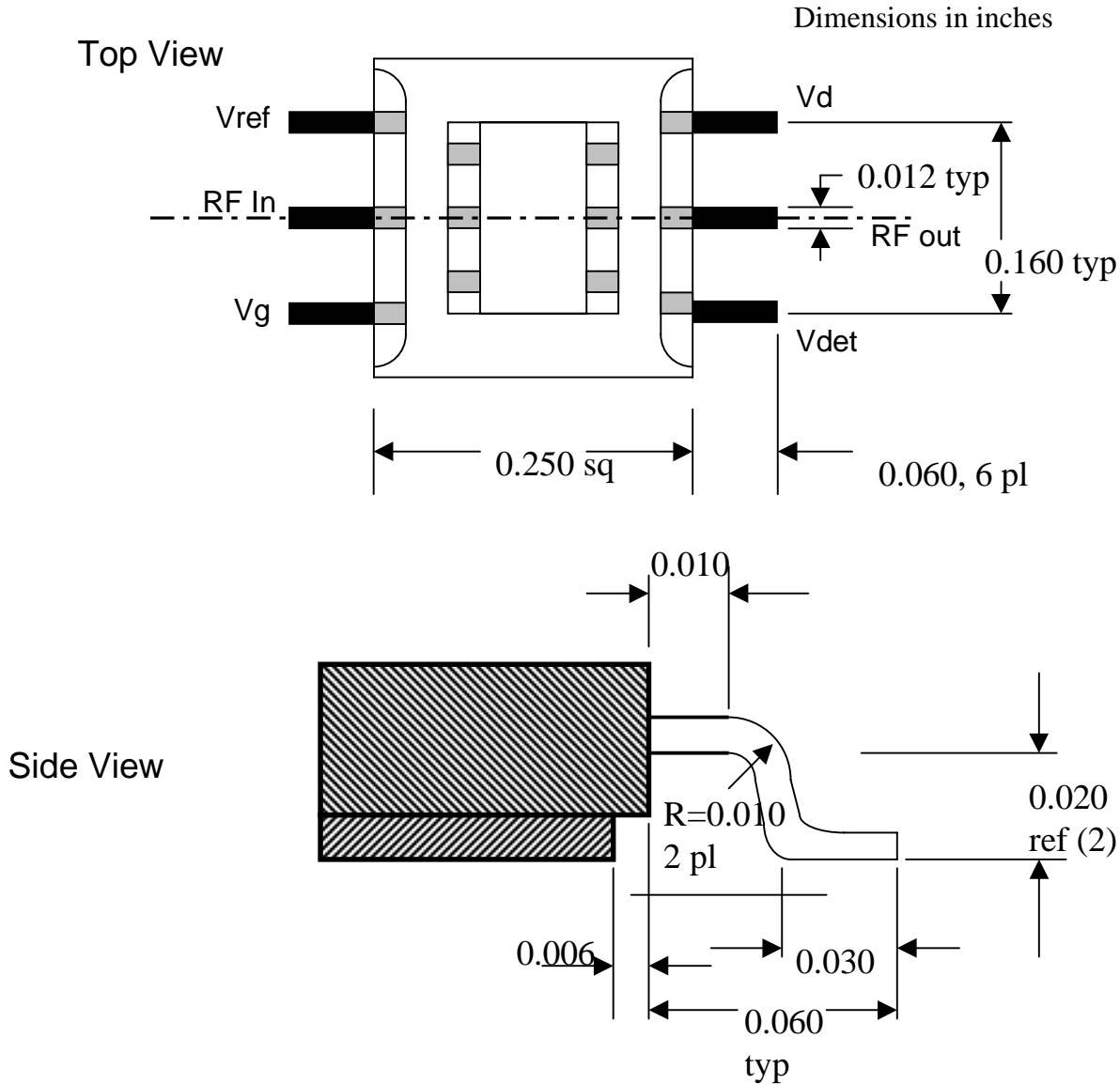

Bias Procedure

1. Make sure no RF power is applied to the device before continuing.
2. Pinch off device by setting V_G to $-1.5V$.
3. Raise V_d to 7.0V while monitoring drain current.
4. Raise V_g until drain current reaches 680 mA.
5. Apply RF power.

GaAs MMIC devices are susceptible to damage from Electrostatic Discharge. Proper precautions should be observed during handling, assembly and test.

Note: Devices designated as EPU are typically early in their characterization process prior to finalizing all electrical and process specifications. Specifications are subject to change without notice.

Power Detector

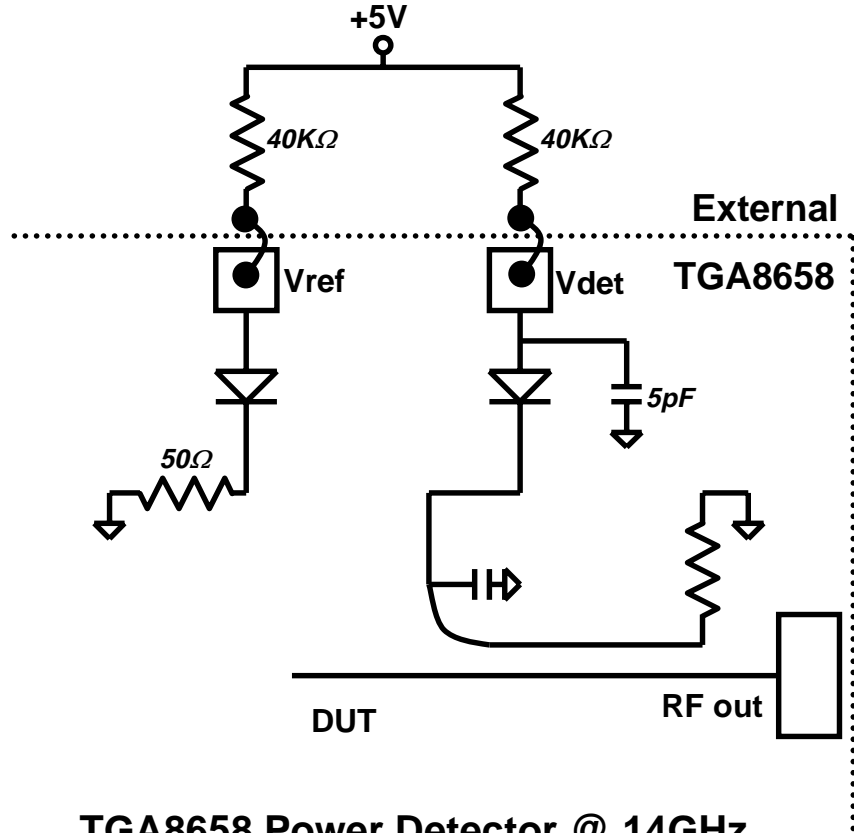

TGA8658 Power Detector @ 14GHz

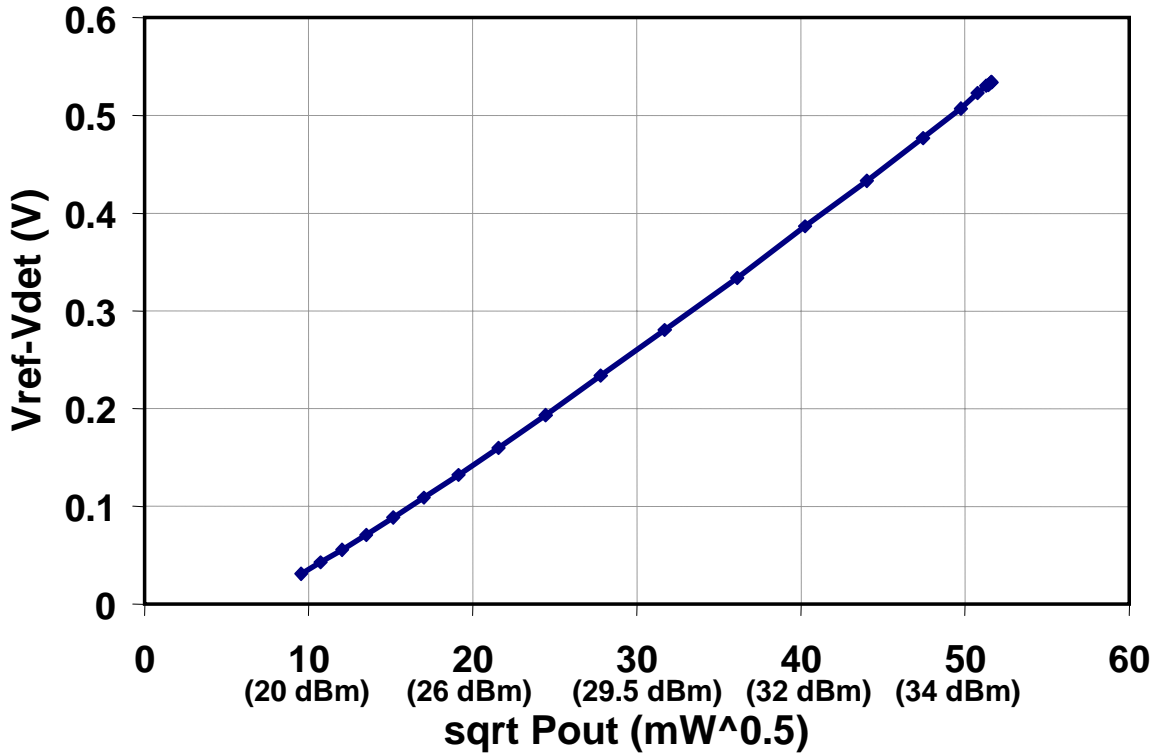

Note: Devices designated as EPU are typically early in their characterization process prior to finalizing all electrical and process specifications. Specifications are subject to change without notice.

Assembly of a TGA8658-EPU-SG Surface Mount Package onto a Motherboard

Manual Assembly for Prototypes

1. Clean the motherboard or the similar module with Acetone. Rinse with alcohol and DI water. Allow the circuit to fully dry.
2. To improve the thermal and RF performance, we recommend a heat sink attach to the bottom of the package and apply indium alloy SN63 solder or Tin Lead solder to the bottom of TGA8658.
3. Apply Tin Lead solder to each pin of TGA8658.
4. Clean the assembly with alcohol.

High Volume Assembly of the Package

The TGA8658EPU is a custom leaded packaged component. High volume assembly can be performed using standard assembly processes including solder printing such as stencil solder printing. Pick-and-place using a standard machine such as a MRSI machine, and solder reflow using a "Sikama Reflow System" using typical zone temperatures: 120, 175, 195, and 215 degrees Celsius at 15 second intervals.

GaAs MMIC devices are susceptible to damage from Electrostatic Discharge. Proper precautions should be observed during handling, assembly and test.

Note: Devices designated as EPU are typically early in their characterization process prior to finalizing all electrical and process specifications. Specifications are subject to change without notice.