

**50 GHz Wideband Analog Attenuator**

**TGL4203-EPU**

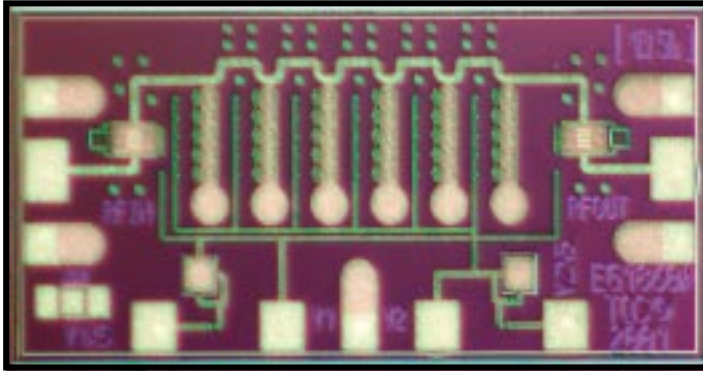

Chip Dimensions 1.7mm x 0.8 mm x 0.1mm

**Key Features and Performance**

- 0.25um 3MI MMW pHEMT
- Broadband Response DC to > 50 GHz
- 2dB typical Insertion Loss
- 17dB Variable Attenuation Range
- 15dB typical Return Loss
- Bias: -1V to 0V

**Primary Applications**

- Point to Point Radio
- Fiber Optic
- Wideband Military & Space

**Typical Electrical Characteristics**

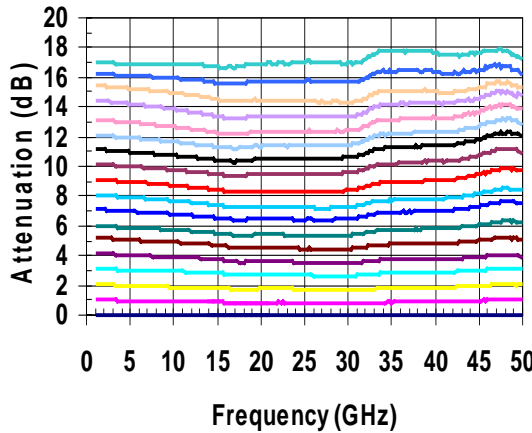
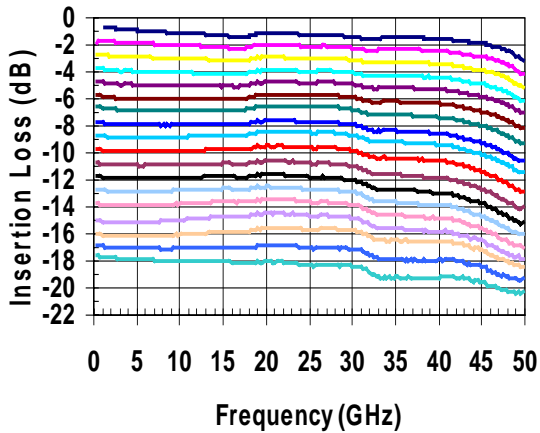

	V1 / V2
REF	0.000 / -1.000
1dB	-0.549 / -0.838
2dB	-0.606 / -0.752
3dB	-0.635 / -0.708
4dB	-0.659 / -0.680
5dB	-0.673 / -0.651
6dB	-0.679 / -0.626
7dB	-0.689 / -0.597
8dB	-0.705 / -0.578
9dB	-0.713 / -0.549
10dB	-0.719 / -0.518
11dB	-0.730 / -0.489
12dB	-0.744 / -0.461
13dB	-0.762 / -0.430
14dB	-0.794 / -0.392
15dB	-0.800 / -0.327
16dB	-0.851 / -0.267
17dB	-0.900 / -0.203

Bias Voltages Optimized for Flatness of Attenuation with respect to Reference over Frequency

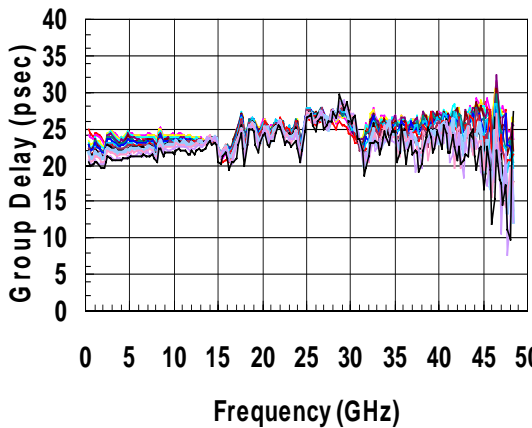
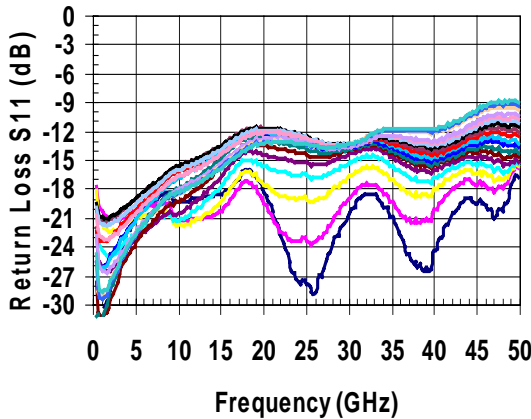

Note: Devices designated as EPU are typically early in their characterization process prior to finalizing all electrical and process specifications. Specifications are subject to change without notice

**TABLE I**  
**MAXIMUM RATINGS 1/**

SYMBOL	PARAMETER	VALUE	NOTES
	Attenuation Control Voltage Range	-5 to +1 V	
I <sub>G1</sub>	Gate 1 Supply Current	2.2 mA	
I <sub>G2</sub>	Gate 2 Supply Current	19.8 mA	
P <sub>IN</sub>	Input Continuous Wave Power	> 30dBm	
P <sub>D</sub>	Power Dissipation	TBD	
T <sub>CH</sub>	Operating Channel Temperature	150 °C	2/ 3/
T <sub>M</sub>	Mounting Temperature (30 Seconds)	320 °C	
T <sub>STG</sub>	Storage Temperature	-65 to 150 °C	

- 1/ These ratings represent the maximum operable values for this device.
- 2/ Junction operating temperature will directly affect the device median time to failure (T<sub>M</sub>). For maximum life, it is recommended that junction temperatures be maintained at the lowest possible levels.
- 3/ These ratings apply to each individual FET.

**TABLE II**  
**ELECTRICAL CHARACTERISTICS**  
(T<sub>a</sub> = 25°C Nominal)

PARAMETER	TEST CONDITIONS	TYP	UNIT
	Attenuation Control Voltage	DC ~ 50 GHz	-1 to 0 V
IL	Insertion Loss	DC ~ 50 GHz	2 dB
	Maximum Attenuation	DC ~ 50 GHz	17 dB
IRL	Input Return Loss	DC ~ 50 GHz	15 dB
ORL	Output Return Loss	DC ~ 50 GHz	15 dB
Pin1dB	Input Power @ 1dB Atten. Change	5 to 25 GHz	* dBm
	Group Delay Variation	DC ~ 50 GHz	+/-5 psec
	Max. Insertion Loss Ripple (peak to peak)	DC ~ 50 GHz	0.5 dB

\* Pin1dB varies depending on Attenuation State and frequency. See graphs on page 3 for details

*Note: Devices designated as EPU are typically early in their characterization process prior to finalizing all electrical and process specifications. Specifications are subject to change without notice*

**Typical Pin1dB vs Attenuation**

Ta = 25°C Nominal

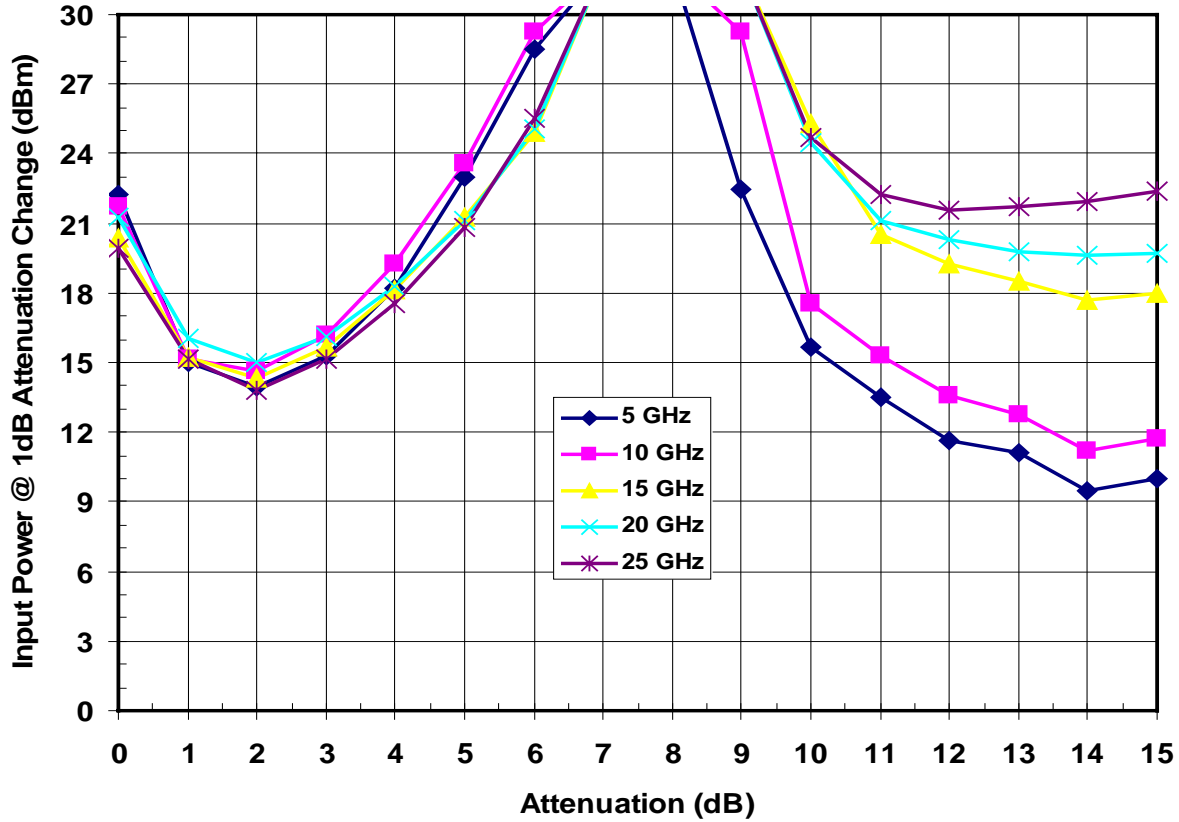

Note: Devices designated as EPU are typically early in their characterization process prior to finalizing all electrical and process specifications. Specifications are subject to change without notice

**Typical Attenuator Input TOI vs. Attenuation**

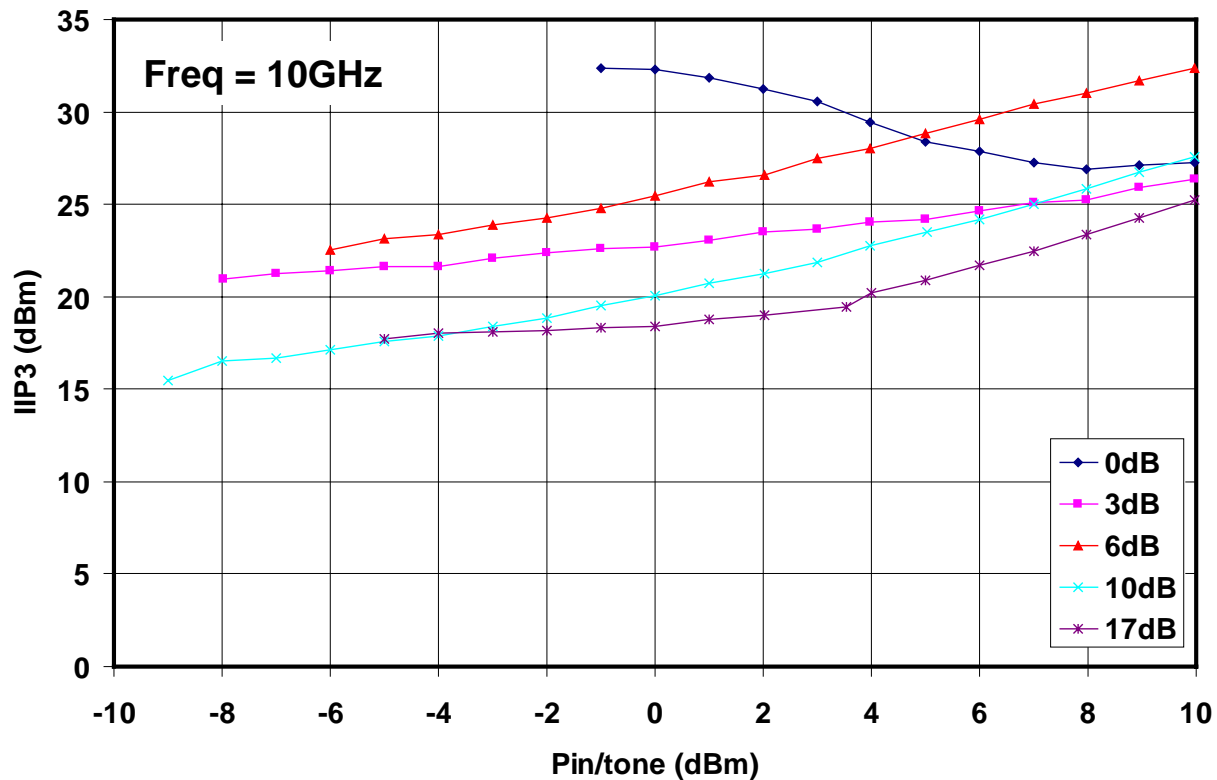
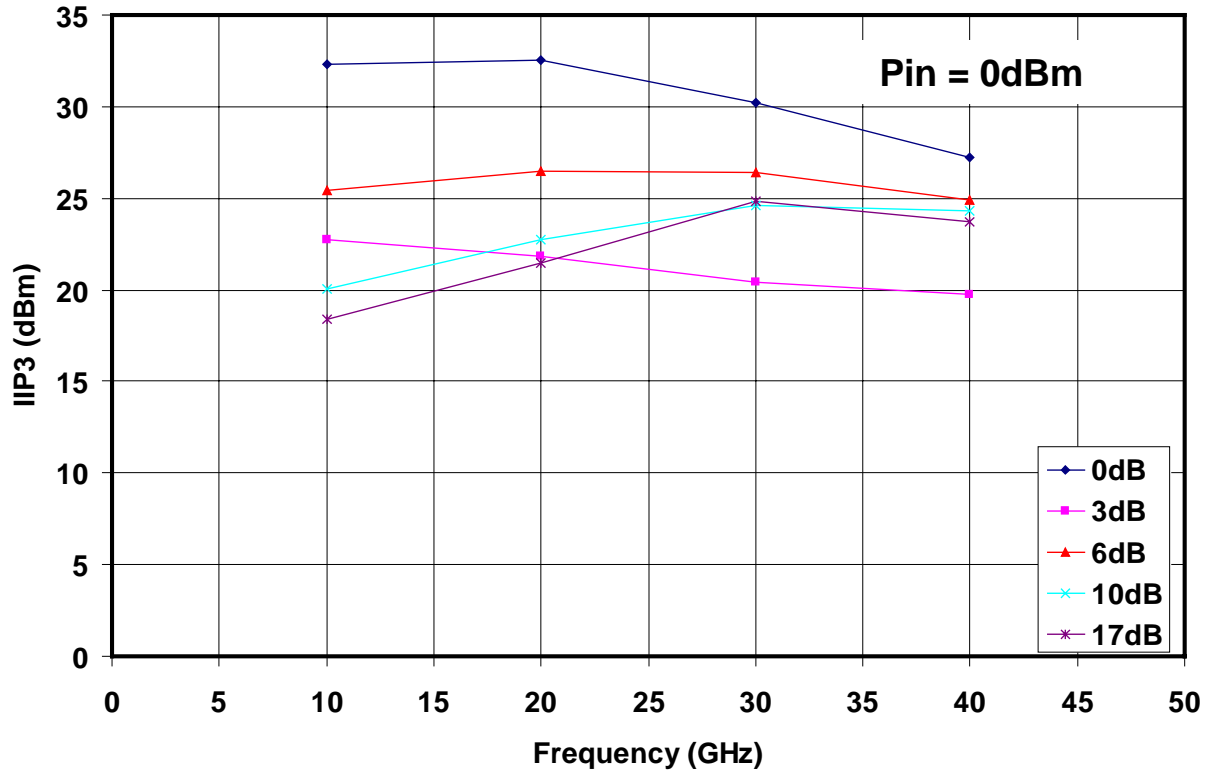

Note: Devices designated as EPU are typically early in their characterization process prior to finalizing all electrical and process specifications. Specifications are subject to change without notice

Typical Attenuator Input TOI vs. Attenuation

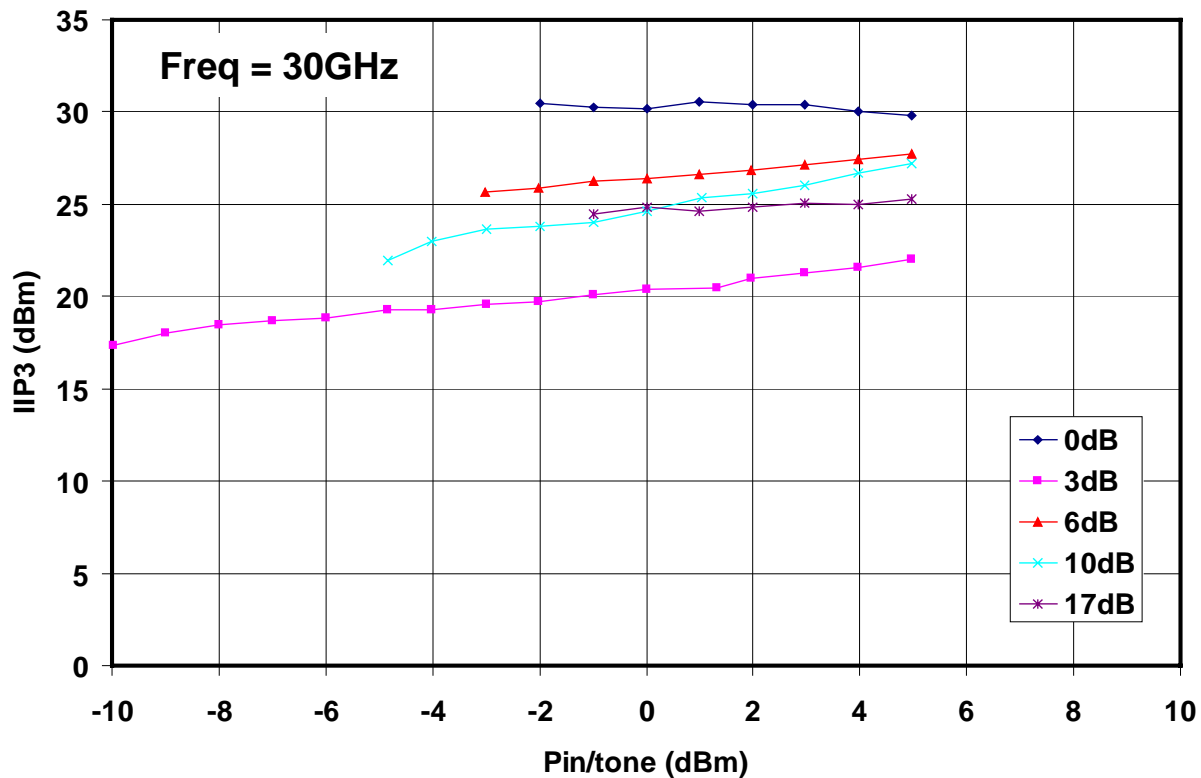
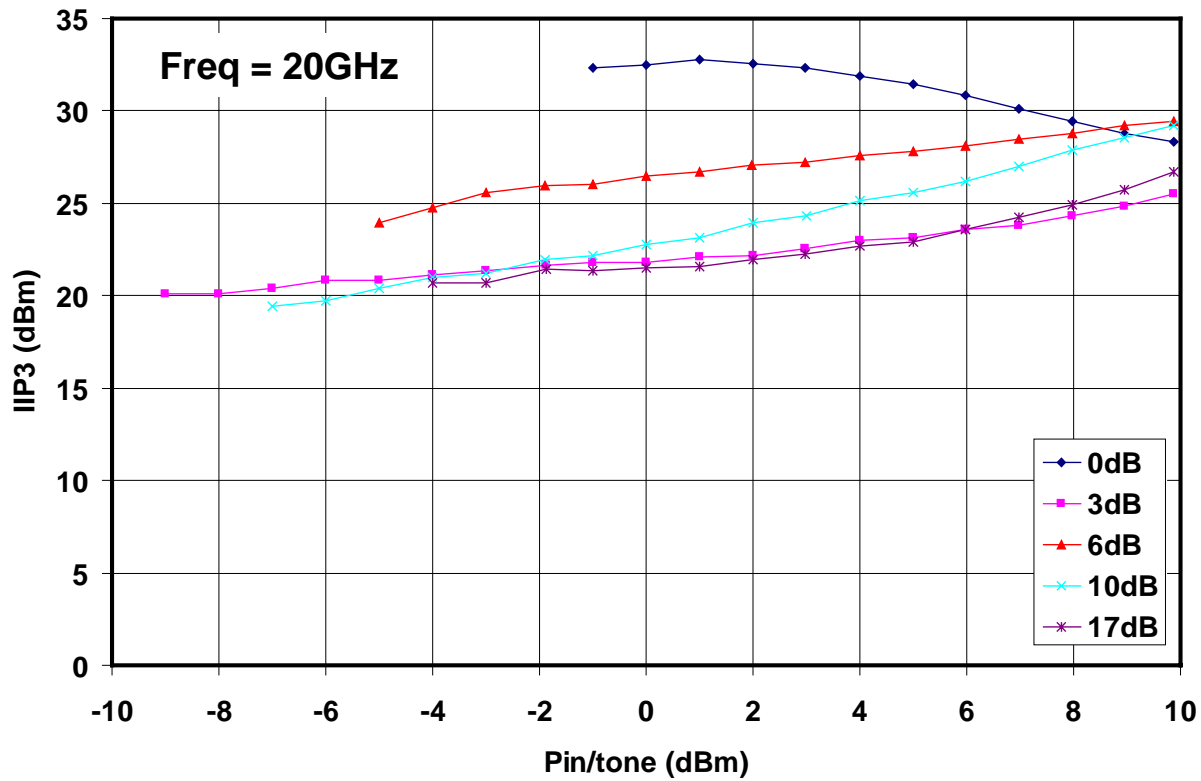

Note: Devices designated as EPU are typically early in their characterization process prior to finalizing all electrical and process specifications. Specifications are subject to change without notice

**Typical Measurement Over Temperature**

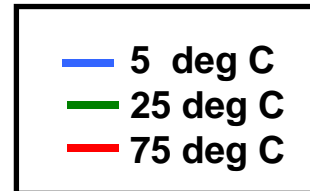
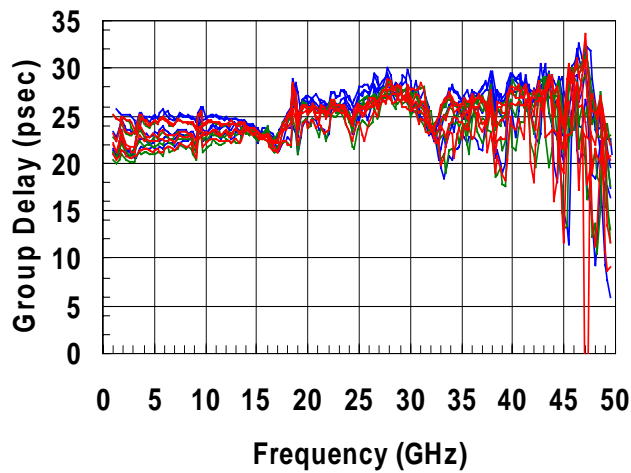
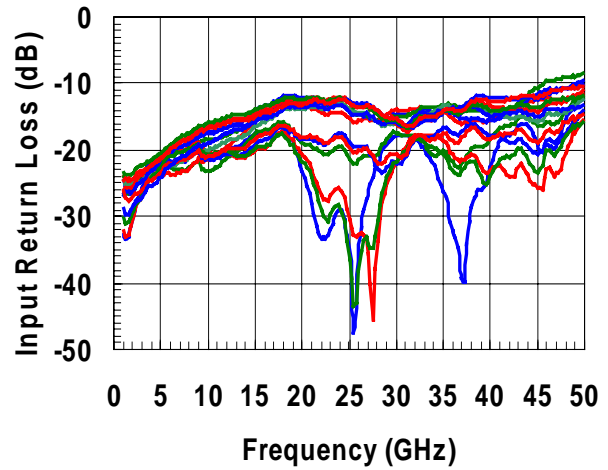
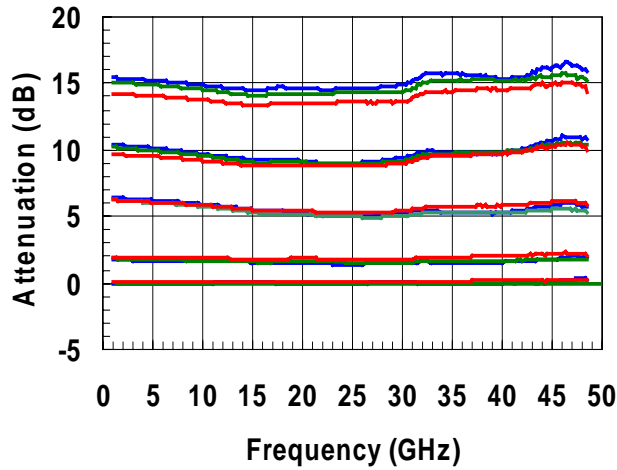

*Note: Devices designated as EPU are typically early in their characterization process prior to finalizing all electrical and process specifications. Specifications are subject to change without notice*

**Mechanical Drawing**

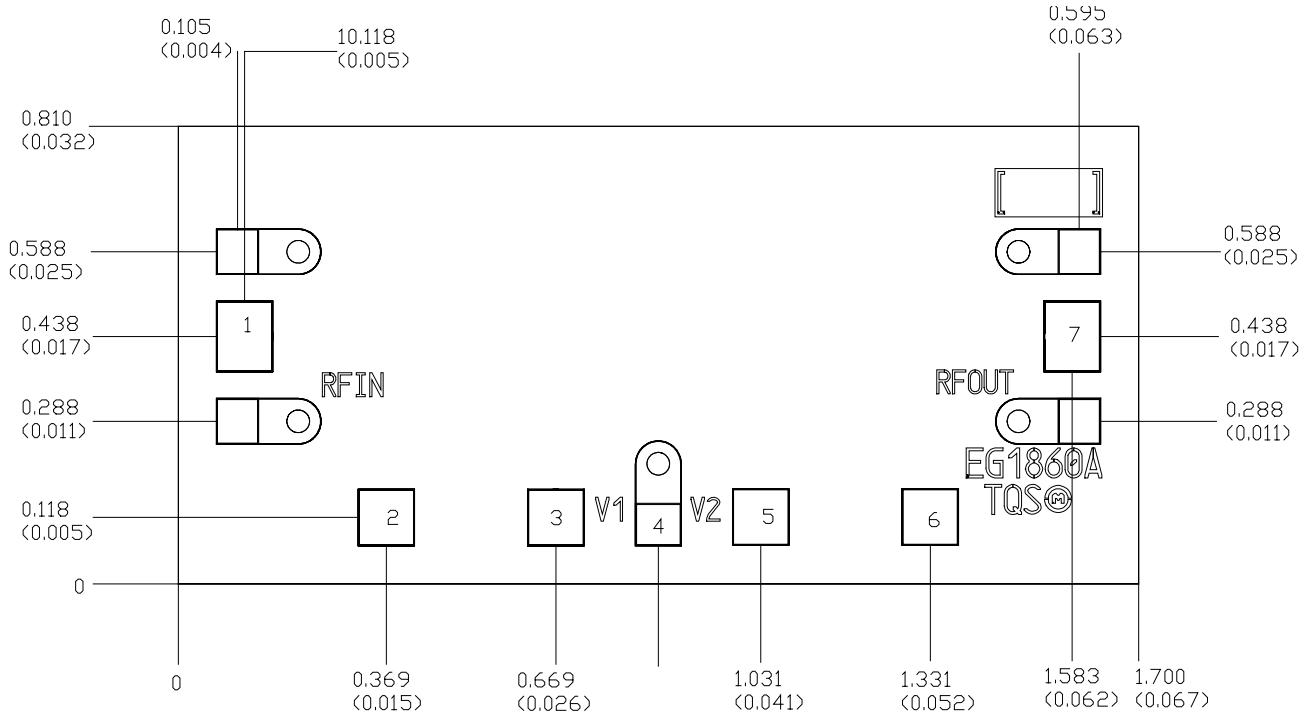

Units: millimeters (inches)

Thickness: 0.100 (0.004)

Chip edge to bond pad dimensions are shown to center of bond pad

Chip size tolerance: +/- 0.051 (0.002)

RF GND is back side of MMIC

Bond pad #1	(RF In)	0.100 x 0.125	(0.004 x 0.005)
Bond pad #2	(NC)	0.100 x 0.100	(0.004 x 0.004)
Bond pad #3	(VG1)	0.100 x 0.100	(0.004 x 0.004)
Bond pad #4	(DC GND)	0.081 x 0.075	(0.003 x 0.003)
Bond pad #5	(VG2)	0.100 x 0.100	(0.004 x 0.004)
Bond pad #6	(NC)	0.100 x 0.100	(0.004 x 0.004)
Bond pad #7	(RF Out)	0.100 x 0.125	(0.004 x 0.005)

**GaAs MMIC devices are susceptible to damage from Electrostatic Discharge. Proper precautions should be observed during handling, assembly and test.**

Note: Devices designated as EPU are typically early in their characterization process prior to finalizing all electrical and process specifications. Specifications are subject to change without notice

**DC Schematic**

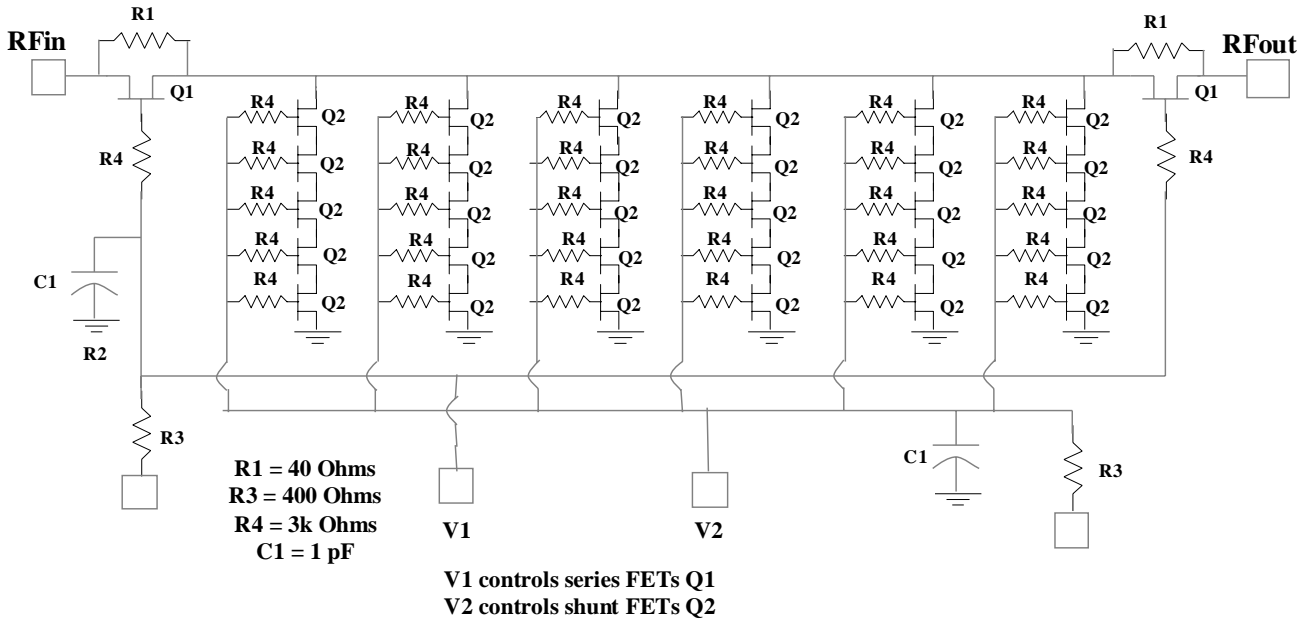

**GaAs MMIC devices are susceptible to damage from Electrostatic Discharge. Proper precautions should be observed during handling, assembly and test.**

*Note: Devices designated as EPU are typically early in their characterization process prior to finalizing all electrical and process specifications. Specifications are subject to change without notice*



### Chip Assembly Diagram

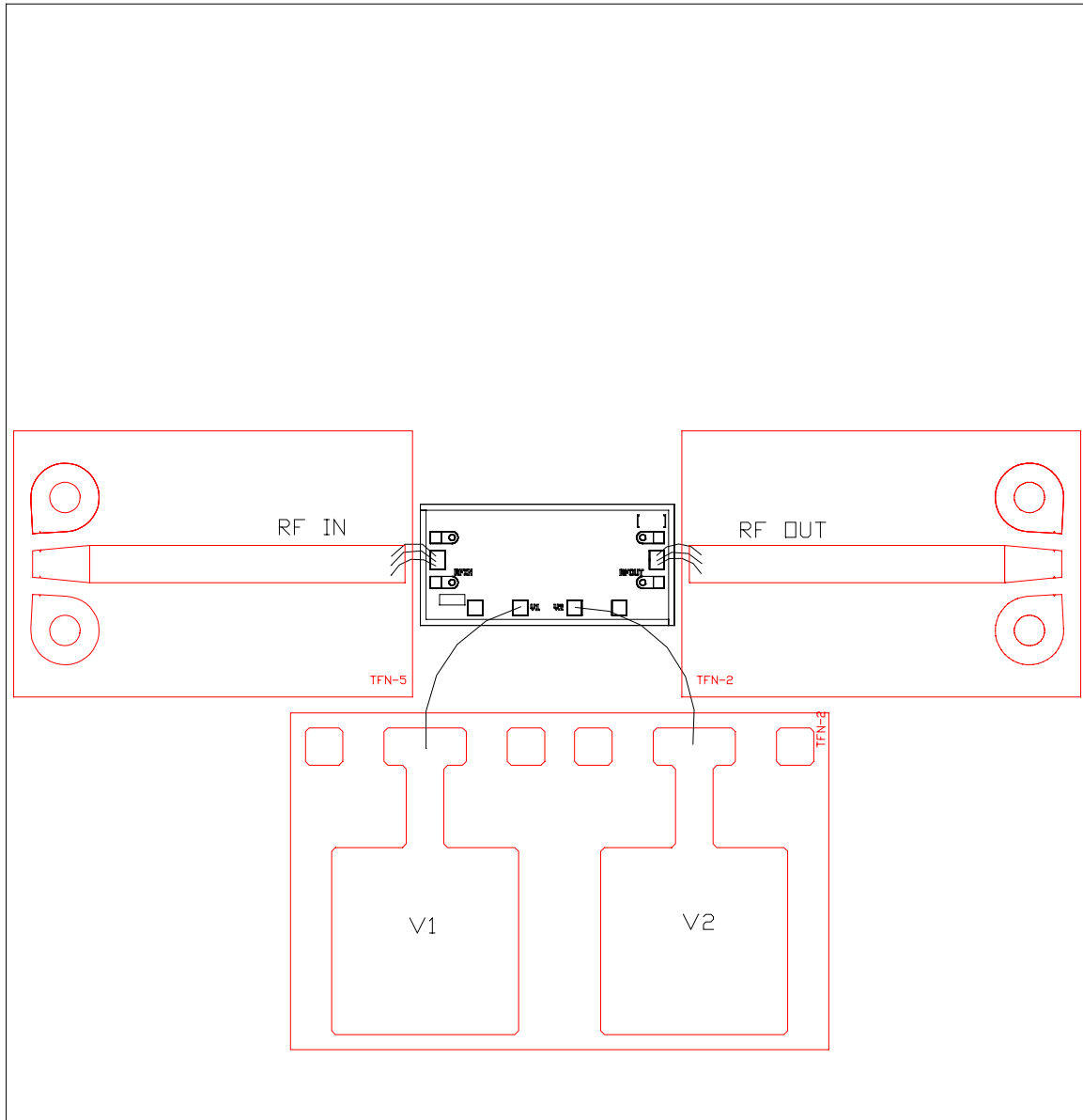

**RF Ports must be DC Blocked**

**GaAs MMIC devices are susceptible to damage from Electrostatic Discharge. Proper precautions should be observed during handling, assembly and test.**

*Note: Devices designated as EPU are typically early in their characterization process prior to finalizing all electrical and process specifications. Specifications are subject to change without notice*

## Assembly Process Notes

Reflow process assembly notes:

- Use AuSn (80/20) solder with limited exposure to temperatures at or above 300°C (30 seconds max).
- An alloy station or conveyor furnace with reducing atmosphere should be used.
- No fluxes should be utilized.
- Coefficient of thermal expansion matching is critical for long-term reliability.
- Devices must be stored in a dry nitrogen atmosphere.

Component placement and adhesive attachment assembly notes:

- Vacuum pencils and/or vacuum collets are the preferred method of pick up.
- Air bridges must be avoided during placement.
- The force impact is critical during auto placement.
- Organic attachment can be used in low-power applications.
- Curing should be done in a convection oven; proper exhaust is a safety concern.
- Microwave or radiant curing should not be used because of differential heating.
- Coefficient of thermal expansion matching is critical.

Interconnect process assembly notes:

- Thermosonic ball bonding is the preferred interconnect technique.
- Force, time, and ultrasonics are critical parameters.
- Aluminum wire should not be used.
- Discrete FET devices with small pad sizes should be bonded with 0.0007-inch wire.
- Maximum stage temperature is 200°C.

***GaAs MMIC devices are susceptible to damage from Electrostatic Discharge. Proper precautions should be observed during handling, assembly and test.***

*Note: Devices designated as EPU are typically early in their characterization process prior to finalizing all electrical and process specifications. Specifications are subject to change without notice*