



# FRA801G THRU FRA807G

## 8.0 AMPS. Glass Passivated Fast Recovery Rectifiers



Voltage Range  
50 to 1000 Volts  
Current  
8.0 Amperes

### Features

- ◇ Low forward voltage drop
- ◇ High current capability
- ◇ High reliability
- ◇ High surge current capability

### Mechanical Data

- ◇ Cases: Molded plastic
- ◇ Epoxy: UL 94V-0 rate flame retardant
- ◇ Terminals: Leads solderable per MIL-STD-202, Method 208 guaranteed
- ◇ Polarity: As marked
- ◇ High temperature soldering guaranteed: 260°C/10 seconds .16", (4.06mm) from case.
- ◇ Mounting position: Any
- ◇ Weight: 2.24 grams

### TO-220A

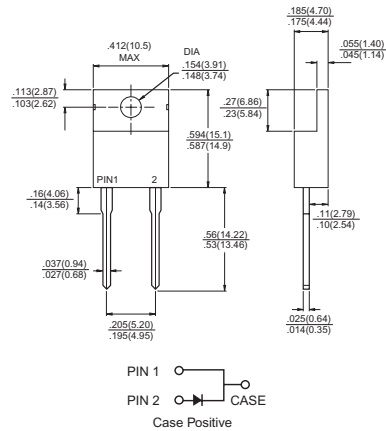

Dimensions in inches and (millimeters)

### Maximum Ratings and Electrical Characteristics

Rating at 25°C ambient temperature unless otherwise specified.

Single phase, half wave, 60 Hz, resistive or inductive load.

For capacitive load, derate current by 20%

Type Number	Symbol	FRA 801G	FRA 802G	FRA 803G	FRA 804G	FRA 805G	FRA 806G	FRA 807G	Units
Maximum Recurrent Peak Reverse Voltage	$V_{RRM}$	50	100	200	400	600	800	1000	V
Maximum RMS Voltage	$V_{RMS}$	35	70	140	280	420	560	700	V
Maximum DC Blocking Voltage	$V_{DC}$	50	100	200	400	600	800	1000	V
Maximum Average Forward Rectified Current @ $T_C = 55^\circ\text{C}$	$I_{(AV)}$	8.0							A
Peak Forward Surge Current, 8.3 ms Single Half Sine-wave Superimposed on Rated Load (JEDEC method)	$I_{FSM}$	150							A
Maximum Instantaneous Forward Voltage @ 8.0A	$V_F$	1.3							V
Maximum DC Reverse Current @ $T_C=25^\circ\text{C}$ at Rated DC Blocking Voltage @ $T_C=125^\circ\text{C}$	$I_R$	5.0 100							uA uA
Maximum Reverse Recovery Time ( Note 2 )	$T_{rr}$	150			250	500	nS		
Typical Junction Capacitance ( Note 1 ) $T_J=25^\circ\text{C}$	$C_j$	60							pF
Typical Thermal Resistance (Note 3)	$R\theta_{JC}$	3.0							$^{\circ}\text{C}/\text{W}$
Operating and Storage Temperature Range	$T_J, T_{STG}$	-65 to +150							$^{\circ}\text{C}$

Notes: 1. Measured at 1 MHz and Applied Reverse Voltage of 4.0 Volts D.C.

2. Reverse Recovery Test Conditions:  $I_F=0.5\text{A}$ ,  $I_R=1.0\text{A}$ ,  $I_{RR}=0.25\text{A}$

3. Thermal Resistance from Junction to Case, with Heatsink size 2" x 3" x 0.25" Al-Plate

## RATINGS AND CHARACTERISTIC CURVES (FRA801G THRU FRA807G)

FIG.1- REVERSE RECOVERY TIME CHARACTERISTIC AND TEST CIRCUIT DIAGRAM

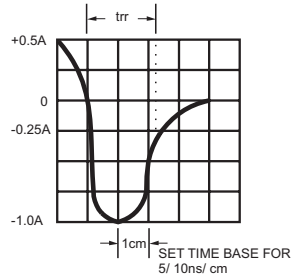
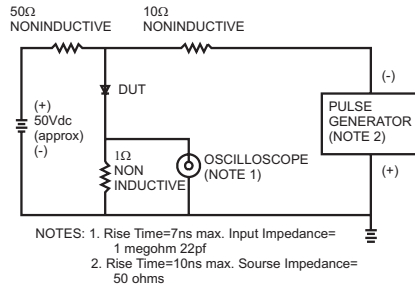

FIG.2- MAXIMUM FORWARD CURRENT DERATING CURVE

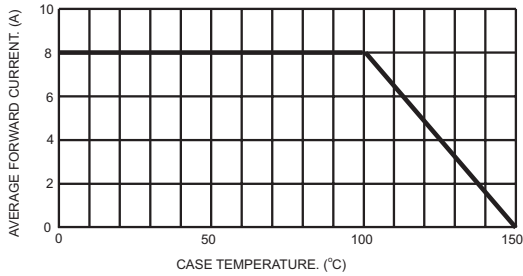

FIG.5- TYPICAL INSTANTANEOUS FORWARD CHARACTERISTICS

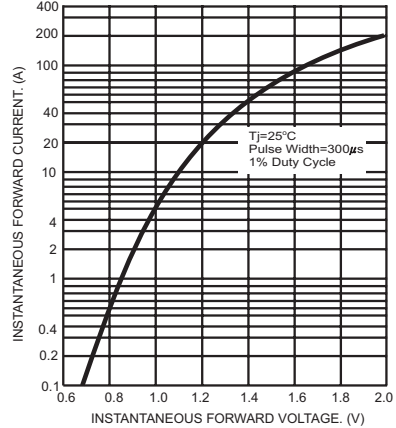

FIG.3- MAXIMUM NON-REPETITIVE FORWARD SURGE CURRENT

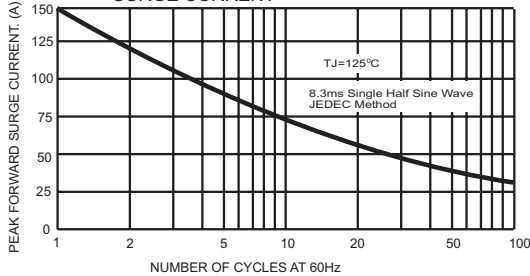

FIG.6- TYPICAL REVERSE CHARACTERISTICS

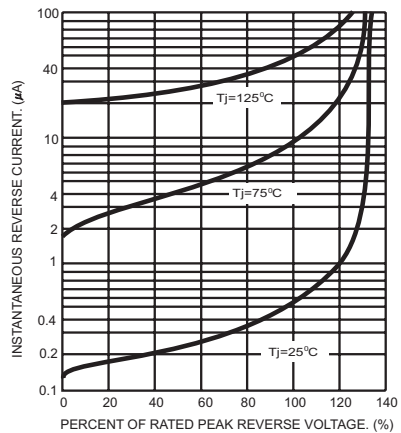

FIG.4- TYPICAL JUNCTION CAPACITANCE

