

## 20-40GHz Medium Power Amplifier

### GaAs Monolithic Microwave IC

#### Description

The CHA3093c is a high gain broadband four-stage monolithic medium power amplifier. It is designed for a wide range of applications, from military to commercial communication systems. The backside of the chip is both RF and DC grounded. This helps simplify the assembly process.

A B.I.T. ( Build In Test ) monitors a DC voltage that is representative of the microwave output power.

The circuit is manufactured with a PM-HEMT process, 0.15 $\mu$ m gate length, via holes through the substrate, air bridges and electron beam gate lithography. It is available in chip form.

#### Main Features

- Broadband performances : 20-40GHz
- 20dBm output power.
- 22dB gain
- Very good broadband input matching
- On chip output power level DC detector
- Low DC power consumption, 330mA @ 3.5V
- Chip size : 0.83 X 1.72 X 0.10 mm

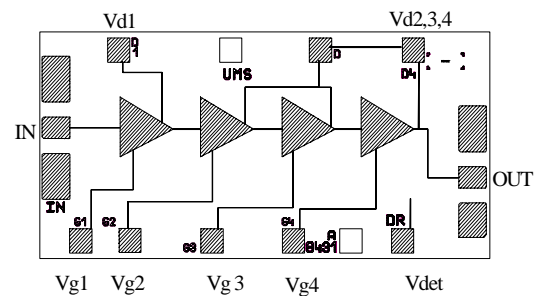

Typical on wafer measurements :

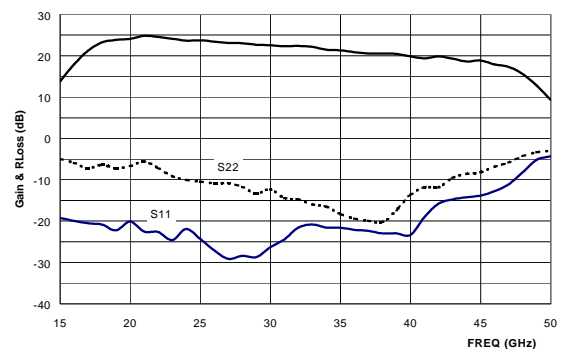

Input Rloss : solid line & output Rloss : dash line.

#### Main Characteristics

Tamb. = 25°C

	Parameter	Min	Typ	Max	Unit
Fop	Operating frequency range	20		40	GHz
G	Small signal gain	18	20		dB
P03	Output power at 3dB gain compression	20	22		dBm
Id	Bias current		330	400	mA

ESD Protection : Electrostatic discharge sensitive device. Observe handling precautions !

**Electrical Characteristics for Broadband Operation**T<sub>amb</sub> = +25°C, V<sub>d1,2,3,4</sub> = 3.5V I<sub>d</sub>=330mA

Symbol	Parameter	Min	Typ	Max	Unit
Fop	Operating frequency range (1)	20		40	GHz
G	Small signal gain [ 20GHz to 35GHz](1)	20	22		dB
G	Small signal gain (1)	18			dB
ΔG	Small signal gain flatness (1) (Any 1GHz BW)		±0.5		dB
I <sub>s</sub>	Reverse isolation (1)		50		dB
P1dB	Pulsed output power at 1dB gain compression (1)	18	20		dBm
P3dB	Pulsed output power at 3dB gain compression (1)	20	22		dBm
IP3	3 <sup>rd</sup> order intercept point		29		dBm
PAE	Power added efficiency at saturation		10		%
VSWR <sub>in</sub>	Input VSWR (1)		1.2:1	2.0:1	
VSWR <sub>out</sub>	Output VSWR (1)		2.0:1	3.0:1	
NF	Noise figure		8.0	10.0	dB
V <sub>det</sub>	Detected voltage : at 25GHz @ P <sub>out</sub> =20dBm (2) Detected voltage : at 38GHz @ P <sub>out</sub> =20dBm (2)		0.65 0.45		V V
I <sub>d</sub>	Bias current (small signal)		330	400	mA

(1) These values are representative for pulsed on-wafer measurements that are made without bonding wires at the RF ports.

(2) In the case of a jig or a module CW mode operation, the typical output power may be around 2dB less.

(2) Voltage across an external 10kOhm parallel resistor connected to the voltage detector pad.

**Absolute Maximum Ratings (1)**

Symbol	Parameter	Values	Unit
V <sub>ds</sub>	Drain bias voltage_small signal (2)	4.0	V
I <sub>ds</sub>	Drain bias current_small signal	470	mA
V <sub>gs</sub>	Gate bias voltage	-2 to +0.4	V
V <sub>dg</sub>	Drain Gate voltage (V <sub>ds</sub> – V <sub>gs</sub> )	+5	V
P <sub>in</sub>	Maximum continuous input power (2) Maximum peak input power overdrive (3)	+4 (@ 20GHz) -1 (@ 40GHz) +15	dBm dBm
T <sub>a</sub>	Operating temperature range	-40 to +85	°C
T <sub>stg</sub>	Storage temperature range	-55 to +125	°C

(1) Operation of this device above anyone of these parameters may cause permanent damage.

(2) Duration &lt; 1s.

### Typical Scattering Parameters ( On wafer $S_{ij}$ measurements )

Bias Conditions :  $V_{d1,2,3,4} = 3.5$  Volt,  $V_{g1}=V_{g2,3,4}$  for  $I_d$  total = 330 mA.

Freq	S11		S12		S21		S22	
	mod	pha	mod	pha	mod	pha	mod	pha
GHz	dB	°	dB	°	dB	°	dB	°
2,00	-9,77	166,10	-79,63	85,41	-44,50	11,25	-0,06	-16,47
4,00	-9,97	159,94	-78,88	19,46	-45,28	64,07	-0,17	-32,94
6,00	-10,97	144,60	-63,16	-150,36	-32,41	-15,70	-0,26	-48,70
8,00	-12,23	141,58	-67,81	-92,96	-30,97	-73,10	-0,19	-66,41
10,00	-13,30	132,93	-76,00	168,10	-39,55	-81,72	-0,32	-86,37
12,00	-14,19	127,48	-69,79	162,87	-12,99	-8,19	-0,95	-109,99
14,00	-15,25	119,12	-68,09	-141,61	4,59	-92,82	-3,13	-134,29
16,00	-16,90	109,51	-56,64	151,79	14,64	166,69	-6,28	-148,92
18,00	-18,45	101,39	-77,66	-40,17	20,56	66,78	-12,44	-152,39
20,00	-18,27	99,66	-54,79	30,38	23,06	-25,87	-11,02	-127,42
21,00	-20,55	75,06	-69,47	-61,55	23,87	-67,24	-8,60	-138,79
22,00	-20,72	49,52	-57,54	-51,49	24,20	-106,39	-7,90	-148,31
23,00	-29,56	58,15	-54,03	-168,51	23,40	-146,58	-10,21	-167,46
24,00	-23,58	58,28	-56,11	107,75	22,98	-173,95	-10,20	-161,72
25,00	-21,33	29,56	-54,05	67,67	22,93	156,61	-10,87	-166,58
26,00	-21,32	-8,76	-62,57	-37,46	23,05	125,30	-11,82	179,69
27,00	-22,06	-29,59	-63,41	-139,56	22,56	96,27	-13,75	179,91
28,00	-22,21	-31,27	-56,43	165,63	21,93	70,69	-13,72	-176,79
29,00	-19,66	-44,67	-59,88	138,12	22,19	43,16	-13,95	168,88
30,00	-17,80	-56,40	-58,46	132,33	21,80	16,81	-15,15	167,61
31,00	-17,46	-61,68	-56,48	154,53	21,36	-6,65	-15,78	157,73
32,00	-15,16	-70,64	-52,06	105,41	21,50	-31,90	-15,57	137,58
33,00	-15,09	-83,96	-56,43	63,48	20,88	-56,82	-20,24	133,08
34,00	-14,57	-89,19	-59,91	89,24	20,82	-81,12	-19,36	132,46
35,00	-13,80	-92,45	-54,72	94,43	20,70	-104,79	-18,36	101,23
36,00	-13,55	-97,98	-54,97	59,43	20,47	-129,10	-20,65	80,50
37,00	-12,80	-102,27	-54,75	93,32	20,11	-154,27	-17,69	61,37
38,00	-12,55	-108,34	-54,06	58,24	19,72	-177,11	-18,18	37,45
39,00	-12,64	-110,41	-53,05	50,25	19,84	159,83	-15,31	24,91
40,00	-12,53	-108,87	-50,99	30,11	19,49	133,90	-13,49	5,75
41,00	-11,23	-110,01	-52,73	3,78	19,40	108,31	-11,73	-9,23
42,00	-10,73	-118,61	-56,04	22,66	18,88	81,37	-11,60	-21,67
43,00	-10,79	-124,01	-56,86	-6,86	18,38	56,83	-10,29	-23,61
44,00	-10,93	-121,39	-52,92	-31,58	18,36	32,20	-8,52	-33,55
45,00	-10,92	-125,62	-52,23	-85,31	18,33	-0,36	-7,30	-45,47
46,00	-11,37	-121,74	-60,67	-166,71	17,03	-37,26	-7,39	-51,37
48,00	-8,41	-103,89	-53,21	-121,20	13,67	-104,46	-4,69	-68,35
50,00	-5,96	-119,91	-58,10	116,39	6,60	-158,83	-3,75	-85,06
52,00	-3,89	-131,50	-52,69	160,04	-0,07	156,43	-3,23	-99,24
54,00	-2,88	-146,98	-60,21	15,97	-7,50	118,68	-2,74	-112,94
56,00	-2,21	-160,52	-52,63	159,63	-16,29	95,16	-2,57	-124,78
58,00	-2,02	-173,49	-55,84	-175,77	-29,86	112,18	-2,56	-135,15
60,00	-1,87	175,37	-49,76	95,59	-23,82	170,18	-2,53	-145,16

**Typical On wafer Power CW Measurements**

Bias Conditions :  $V_{d1,2,3,4} = 3.5$  Volt,  $V_{g1,2,3,4}$  for  $I_d = 330$  mA

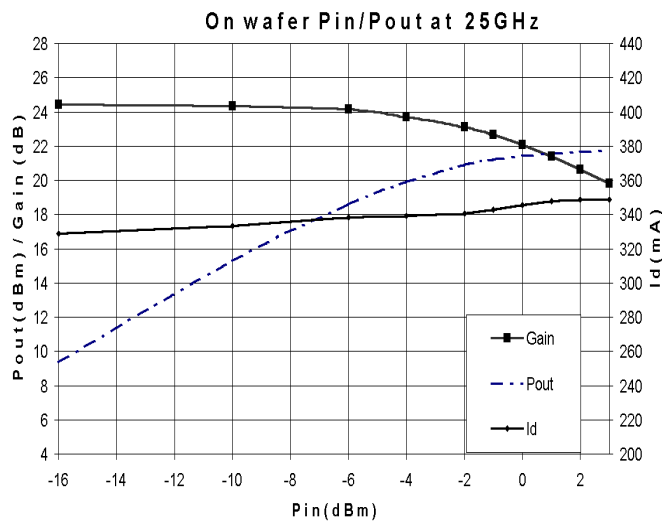
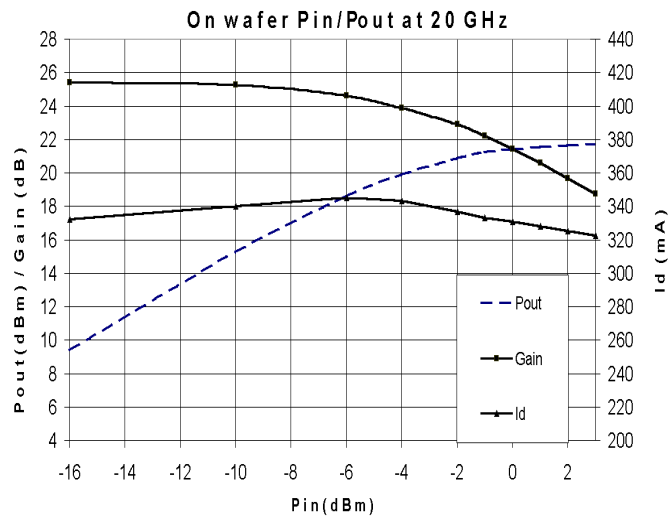

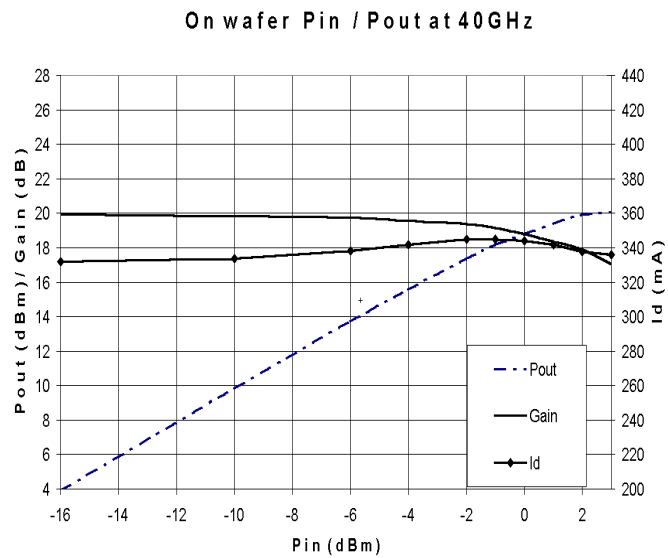
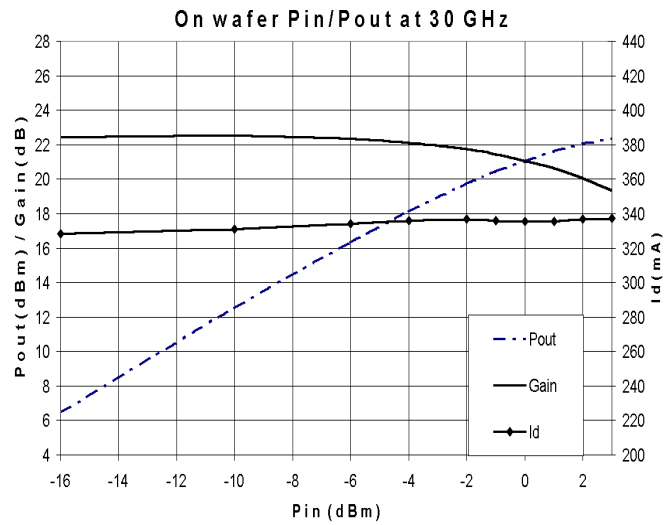

Typical IN TEST JIG Power Measurements in temperature

Note : Jig losses included (1 dB)

Bias Conditions : Vd1,2,3,4 = 3.5 Volt, Vg1,2,3,4 for Id = 330 mA

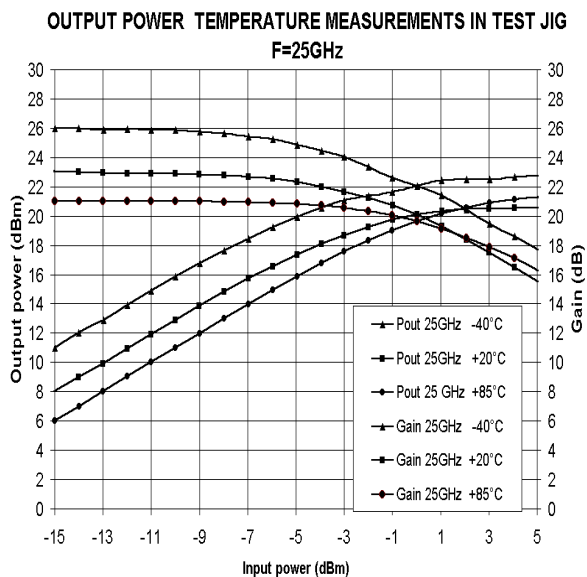
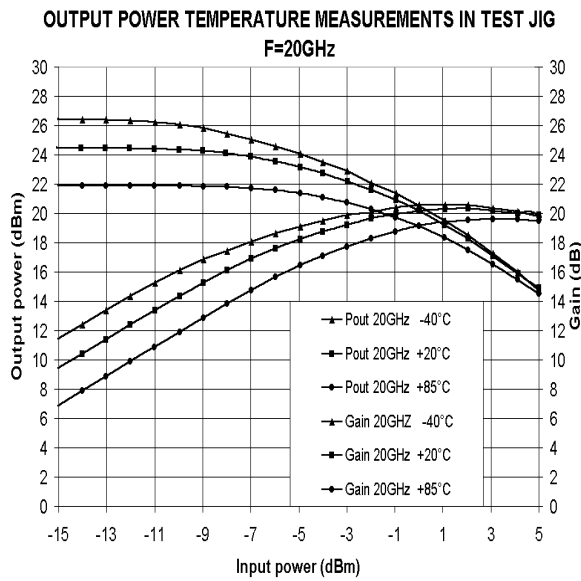

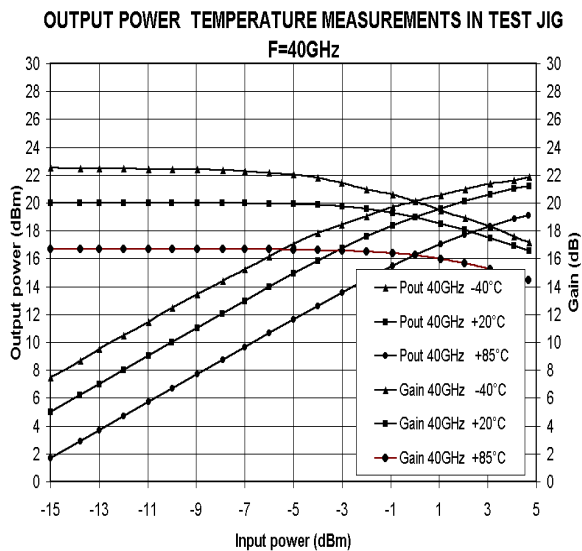
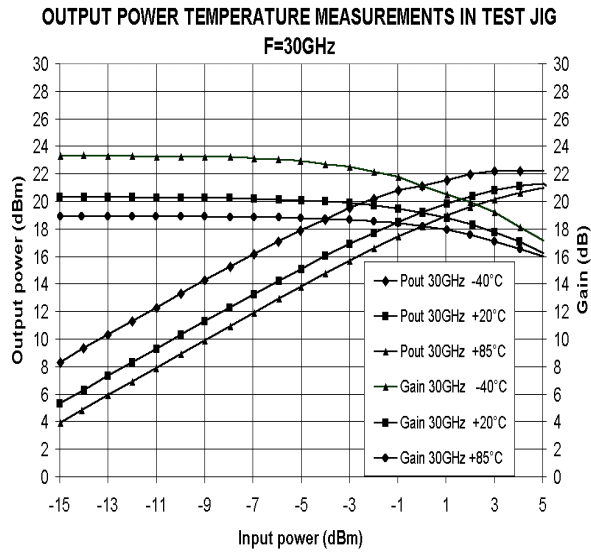

### Typical Bias Tuning

The circuit schematic is given below :

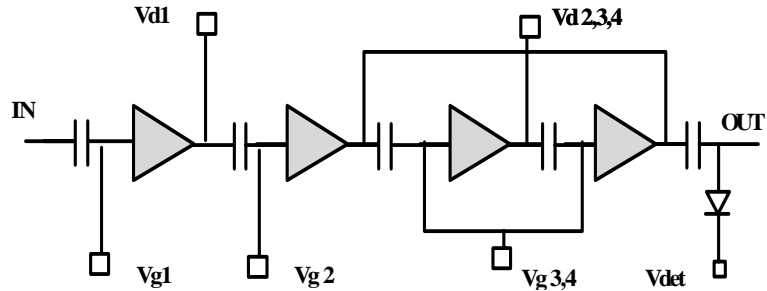

For medium power operation, the four drain biases are connected altogether. In a same way, all the gate biases are connected together at the same power supply, tuned to drive a small signal operating current of 300mA. A separate access to the gate voltages of the two first stages ( Vg1,2 ) is provided in order to be able to tune the first stages for the application, as a lower noise amplifier or a multiplier.

An additional pad is provided for monitoring the output power, using the Build In Test. This access, when connected to an external resistor of 10 kOhm ( typical value ) provides a DC voltage which follows the output power level.

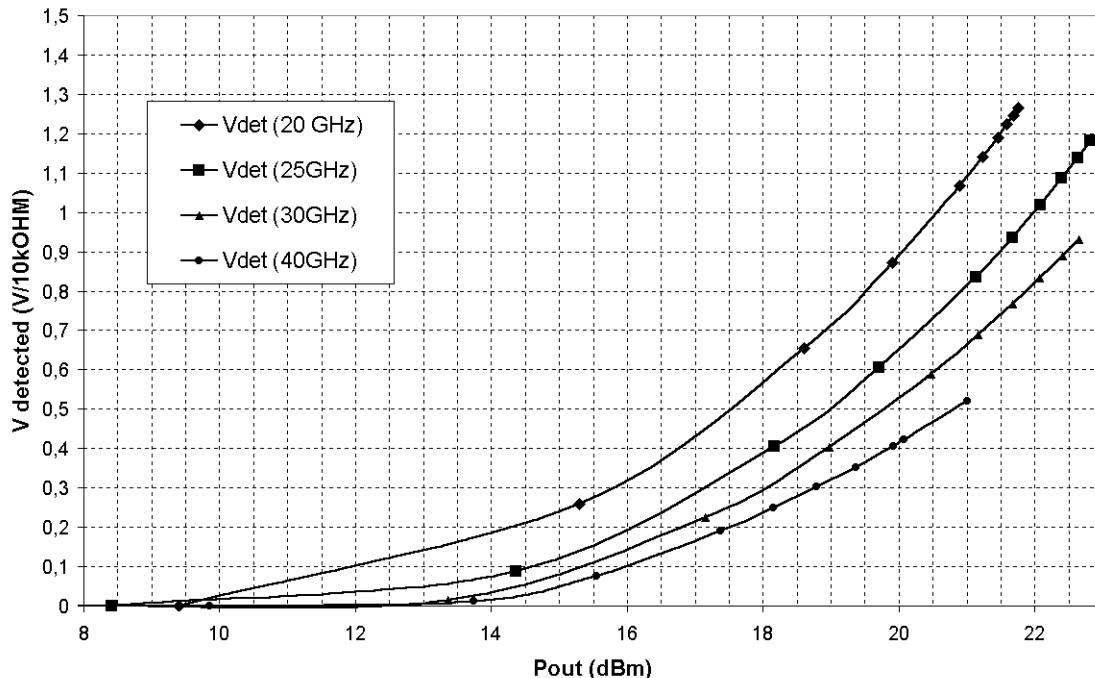

On wafer power measurements versus output power



Chip Assembly and Mechanical Data

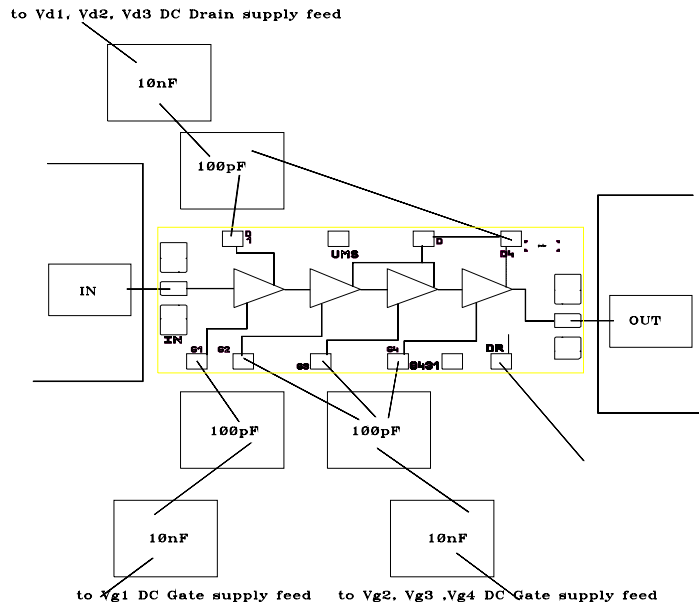

Note : Supply feed should be capacitively bypassed. 25µm diameter gold wire is recommended

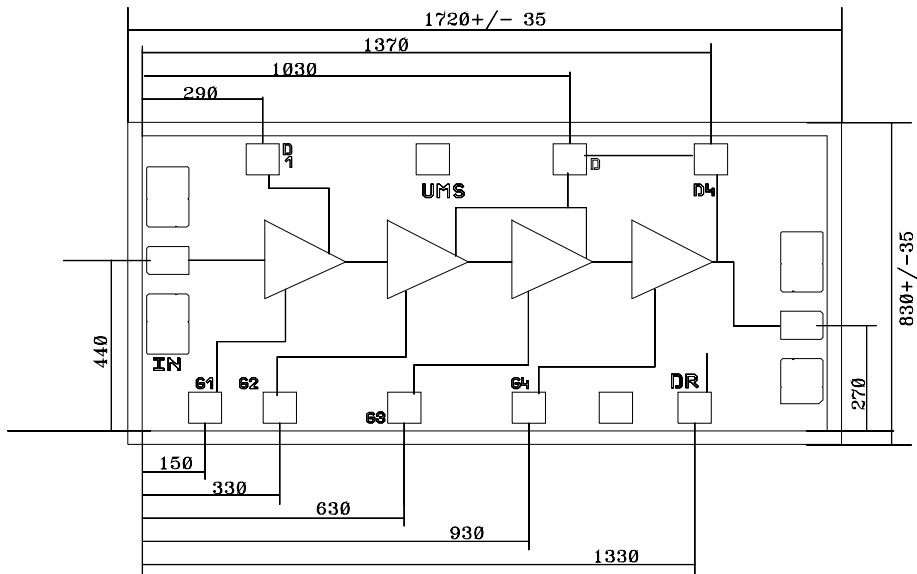

Bonding pad positions.

( Chip thickness : 100µm.all dimensions are in micrometers)

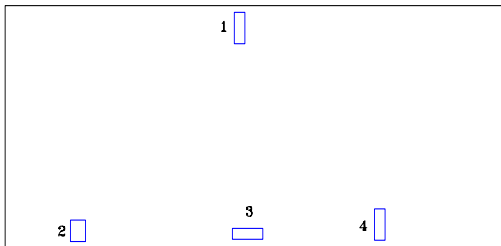

Number	Size (x,y) µm	Center position (x,y) µm (Referred to bottom left origin)
1	34 / 98	773 / 689
2	48 / 68	68 / 34
3	98 / 34	800 / 43
4	34 / 98	1237/ 73

Pickup Pillow

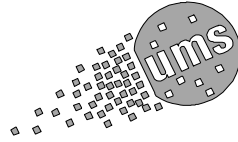

## Ordering Information

Chip form : CHA3093c99F/00

Information furnished is believed to be accurate and reliable. However **United Monolithic Semiconductors S.A.S.** assumes no responsibility for the consequences of use of such information nor for any infringement of patents or other rights of third parties which may result from its use. No license is granted by implication or otherwise under any patent or patent rights of **United Monolithic Semiconductors S.A.S.**. Specifications mentioned in this publication are subject to change without notice. This publication supersedes and replaces all information previously supplied. **United Monolithic Semiconductors S.A.S.** products are not authorised for use as critical components in life support devices or systems without express written approval from **United Monolithic Semiconductors S.A.S.**