

UTC LD1985 LINEAR INTEGRATED CIRCUIT

VERY LOW DROP AND LOW NOISE VOLTAGE REGULATOR LOW ESR CAP. COMPATIBLE, WITH INHIBIT FUNCTION

DESCRIPTION

The UTC LD1985 is a 150mA fixed output voltage regulator. The ultra low drop voltage and the low quiescent current make them particularly suitable for low noise, low power applications, and in battery powered systems. In sleep mode quiescent current is less than $1\mu\text{A}$ when INHIBIT pin is pulled low. Shutdown Logic Control Function is available on pin 3 (TTL compatible). This means that when the device is used as local regulator, it is possible to put a part of the board in standby, decreasing the total power consumption.

An external capacitor, $C_{\text{BYP}}=10\text{nF}$, connected between bypass pin and GND reduce the noise to $30\mu\text{Vrms}$.

Typical application are in cellular phone, palmtop laptop computer, personal digital assistant (PDA), personal stereo, camcorder and camera.

FEATURES

- *VERY LOW DROPOUT VOLTAGE (280mV at 150mA AND 7mV at 1mA LOAD)
- *VERY LOW QUIESCENT CURRENT (2mA Typ. at 150mA LOAD AND $80\mu\text{A}$ at NO LOAD)
- *OUTPUT CURRENT UP TO 150mA
- *LOGIC CONTROLLED ELECTRONIC SHUTDOWN
- *OUTPUT VOLTAGE OF 1.5, 1.8, 2.5, 2.8, 2.85, 3, 3.1, 3.2, 3.3, 3.5, 3.6, 3.8, 4, 4.7, 5V
- *INTERNAL CURRENT AND THERMAL LIMIT
- *AVAILABLE IN $\pm 1\%$ TOLLERANCE (at 25°C , A VERSION)
- *LOW OUTPUT NOISE VOLTAGE $30\mu\text{Vrms}$

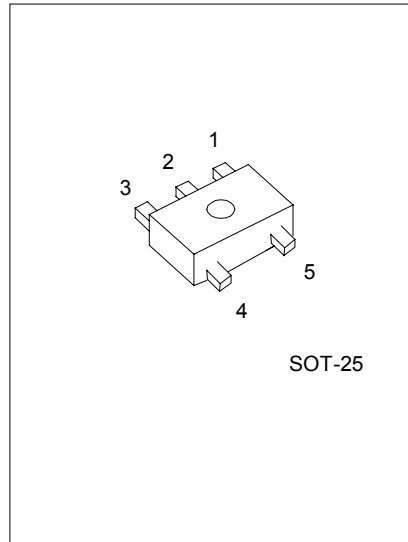

1:VIN 2:GND 3:INHIBIT
4:Bypass 5:Vout

PIN DESCRIPTION

PIN NO.	PIN NAME	FUNCTION
1	IN	Input Port
2	GND	Ground Pin
3	INHIBIT	Control switch ON/OFF. Inhibit is not internally pulled-up; it cannot be left floating. Disable the device when connected to GND or to a positive voltage less than 0.18V
4	Bypass	Bypass Pin: Capacitor to be connected to GND in order to improve the thermal noise performances.
5	OUT	Output Port

UTC LD1985 LINEAR INTEGRATED CIRCUIT

MARKING INFORMATION

PART NUMBER	VOLTAGE	VOLTAGE CODE	PART NUMBER	VOLTAGE	VOLTAGE CODE	MARKING
LD1985-1.5V	1.5V	15	LD1985-3.3V	3.3V	33	
LD1985-1.8V	1.8V	18	LD1985-3.5V	3.5V	35	
LD1985-2.5V	2.5V	25	LD1985-3.6V	3.6V	36	
LD1985-2.8V	2.8V	28	LD1985-3.8V	3.8V	38	
LD1985-2.85V	2.85V	2J	LD1985-4.0V	4.0V	40	
LD1985-3.0V	3.0V	30	LD1985-4.7V	4.7V	47	
LD1985-3.1V	3.1V	31	LD1985-5.0V	5.0V	50	
LD1985-3.2V	3.2V	32				

BLOCK DIAGRAM

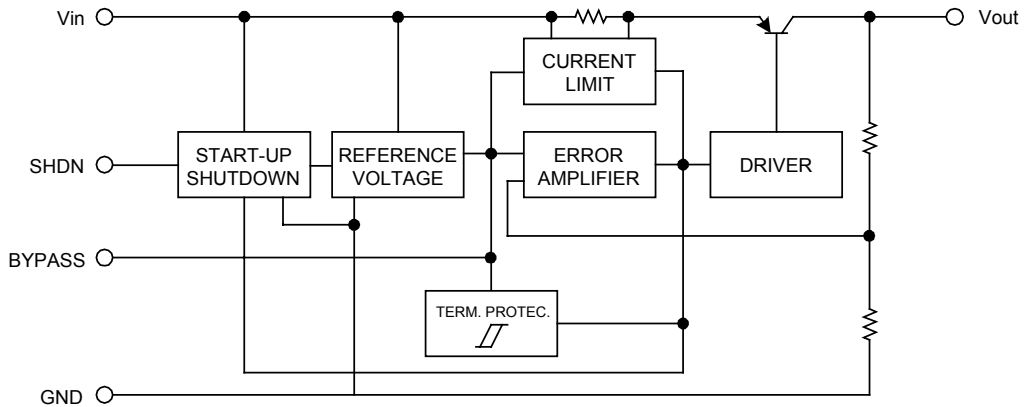

ABSOLUTE MAXIMUM RATINGS

PARAMETER	SYMBOL	RATINGS	UNIT
DC Input Voltage	V_i	7	V
INHIBIT Input Voltage	V_{INH}	7	V
Output Current	I_o	Internally limited	
Power Dissipation	P_{tot}	Internally limited	
Storage Temperature Range	T_{stg}	-65 ~ +150	°C
Operating Junction Temperature Range	T_{op}	-40 ~ +125	°C

THERMAL DATA

PARAMETER	SYMBOL	RATINGS	UNIT
Thermal Resistance Junction-case	$R_{thj-case}$	81	°C/W

UTC LD1985 LINEAR INTEGRATED CIRCUIT

ELECTRICAL CHARACTERISTICS FOR LD1985 $V_o \pm 1.0\%$

($T_J=25^\circ\text{C}$, $V_i=V_o+1\text{V}$, $I_o=1\text{mA}$, $V_{\text{SHDN}}=2\text{V}$, $C_i=1\ \mu\text{F}$, $C_o=1\ \mu\text{F}$, unless otherwise specified)

PARAMETER	SYMBOL	TEST CONDITIONS	MIN	TYP	MAX	UNIT
Operating Input Voltage	V_{op}		2.5		7	V
Output Voltage	V_o	$V_i=2.5\text{V}$	1.485	1.5	1.515	V
		$I_o=1 \sim 150\text{mA}$	1.462		1.538	V
		$I_o=1 \sim 150\text{mA}$, $T_J=-40 \sim 125^\circ\text{C}$	1.447		1.553	V
Output Voltage	V_o	$V_i=2.8\text{V}$	1.782	1.8	1.818	V
		$I_o=1 \sim 150\text{mA}$	1.755		1.845	V
		$I_o=1 \sim 150\text{mA}$, $T_J=-40 \sim 125^\circ\text{C}$	1.737		1.863	V
Output Voltage	V_o	$V_i=3.5\text{V}$	2.475	2.5	2.525	V
		$I_o=1 \sim 150\text{mA}$	2.4375		2.5625	V
		$I_o=1 \sim 150\text{mA}$, $T_J=-40 \sim 125^\circ\text{C}$	2.4125		2.5875	V
Output Voltage	V_o	$V_i=3.8\text{V}$	2.772	2.8	2.828	V
		$I_o=1 \sim 150\text{mA}$	2.730		2.870	V
		$I_o=1 \sim 150\text{mA}$, $T_J=-40 \sim 125^\circ\text{C}$	2.702		2.898	V
Output Voltage	V_o	$V_i=3.85\text{V}$	2.821	2.85	2.879	V
		$I_o=1 \sim 150\text{mA}$	2.778		2.921	V
		$I_o=1 \sim 150\text{mA}$, $T_J=-40 \sim 125^\circ\text{C}$	2.750		2.950	V
Output Voltage	V_o	$V_i=4.0\text{V}$	2.970	3.0	3.030	V
		$I_o=1 \sim 150\text{mA}$	2.925		3.075	V
		$I_o=1 \sim 150\text{mA}$, $T_J=-40 \sim 125^\circ\text{C}$	2.895		3.105	V
Output Voltage	V_o	$V_i=4.1\text{V}$	3.069	3.1	3.131	V
		$I_o=1 \sim 150\text{mA}$	3.022		3.1775	V
		$I_o=1 \sim 150\text{mA}$, $T_J=-40 \sim 125^\circ\text{C}$	2.9915		3.2085	V
Output Voltage	V_o	$V_i=4.2\text{V}$	3.168	3.2	3.232	V
		$I_o=1 \sim 150\text{mA}$	3.120		3.280	V
		$I_o=1 \sim 150\text{mA}$, $T_J=-40 \sim 125^\circ\text{C}$	3.088		3.312	V
Output Voltage	V_o	$V_i=4.3\text{V}$	3.267	3.3	3.333	V
		$I_o=1 \sim 150\text{mA}$	3.2175		3.3825	V
		$I_o=1 \sim 150\text{mA}$, $T_J=-40 \sim 125^\circ\text{C}$	3.1845		3.4155	V
Output Voltage	V_o	$V_i=4.5\text{V}$	3.465	3.5	3.535	V
		$I_o=1 \sim 150\text{mA}$	3.412		3.587	V
		$I_o=1 \sim 150\text{mA}$, $T_J=-40 \sim 125^\circ\text{C}$	3.377		3.622	V
Output Voltage	V_o	$V_i=4.6\text{V}$	3.564	3.6	3.636	V
		$I_o=1 \sim 150\text{mA}$	3.510		3.690	V
		$I_o=1 \sim 150\text{mA}$, $T_J=-40 \sim 125^\circ\text{C}$	3.474		3.726	V
Output Voltage	V_o	$V_i=4.8\text{V}$	3.762	3.8	3.838	V
		$I_o=1 \sim 150\text{mA}$	3.705		3.895	V
		$I_o=1 \sim 150\text{mA}$, $T_J=-40 \sim 125^\circ\text{C}$	3.667		3.933	V
Output Voltage	V_o	$V_i=5.0\text{V}$	3.96	4	4.04	V
		$I_o=1 \sim 150\text{mA}$	3.9		4.1	V
		$I_o=1 \sim 150\text{mA}$, $T_J=-40 \sim 125^\circ\text{C}$	3.86		4.14	V
Output Voltage	V_o	$V_i=5.7\text{V}$	4.653	4.7	4.747	V
		$I_o=1 \sim 150\text{mA}$	4.582		4.817	V
		$I_o=1 \sim 150\text{mA}$, $T_J=-40 \sim 125^\circ\text{C}$	4.5355		4.8645	V
Output Voltage	V_o	$V_i=6.0\text{V}$	4.95	5	5.05	V
		$I_o=1 \sim 150\text{mA}$	4.875		5.125	V
		$I_o=1 \sim 150\text{mA}$, $T_J=-40 \sim 125^\circ\text{C}$	4.825		5.175	V

UTC LD1985 LINEAR INTEGRATED CIRCUIT

PARAMETER	SYMBOL	TEST CONDITIONS	MIN	TYP	MAX	UNIT
Short Circuit Current	I _{sc}	R _L =0		400		mA
Line Regulation	$\Delta V_o/\Delta V_i$	V _i =V _o +1V ~ 16V, I _o =1mA		0.003	0.014	%/V _i
		V _i =V _o +1V ~ 16V, I _o =1mA T _J =-40 ~ 125°C			0.032	%/V _i
Dropout Voltage	V _d	I _o =0		1	3	mV
		T _J =-40 ~ 125°C, I _o =0			5	mV
		I _o =1mA		7	10	mV
		I _o =1mA, T _J =-40 ~ 125°C			15	mV
		I _o =10mA		40	60	mV
		I _o =10mA, T _J =-40 ~ 125°C			90	mV
		I _o =50mA		120	150	mV
		I _o =50mA, T _J =-40 ~ 125°C			225	mV
		I _o =150mA		280	350	mV
		I _o =150mA, T _J =-40 ~ 125°C			575	mV
Quiescent Current	I _d	I _o =0		80	100	μA
		T _J =-40 ~ 125°C, I _o =0			150	μA
		I _o =1mA		100	150	μA
		I _o =1mA, T _J =-40 ~ 125°C			200	μA
		I _o =10mA		200	300	μA
		I _o =10mA, T _J =-40 ~ 125°C			400	μA
		I _o =50mA		600	900	μA
		I _o =50mA, T _J =-40 ~ 125°C			1200	μA
		I _o =150mA		2000	3000	μA
		I _o =150mA, T _J =-40 ~ 125°C			4000	μA
		OFF MODE V _{INH} <0.18V		0		μA
		OFF MODE V _{INH} <0.18V T _J =-40 ~ 125°C			2	μA
Supply Voltage Rejection	SVR	C _{BYP} =0.01 μF, C _O =10 μF, f=1KHz		45		dB
Control Input Logic Low	V _{IL}	T _J =-40 ~ 125°C			0.15	V
Control Input Logic High	V _{IH}	T _J =-40 ~ 125°C	2			V
Control Input Current	I _{INH}	T _J =-40 ~ 125°C, V _{SHDN} =5V		5	15	μA
		T _J =-40 ~ 125°C, V _{SHDN} =0V		0	-1	μA
Output Noise Voltage	e _N	B=300Hz ~ 50KHz C _{BYP} =0.01 μF, C _O =10 μF		30		μV

UTC LD1985 LINEAR INTEGRATED CIRCUIT

ELECTRICAL CHARACTERISTICS FOR LD1985 $V_o \pm 1.5\%$

($T_J=25^\circ\text{C}$, $V_i=V_o+1\text{V}$, $I_o=1\text{mA}$, $V_{\text{SHDN}}=2\text{V}$, $C_i=1\ \mu\text{F}$, $C_o=1\ \mu\text{F}$, unless otherwise specified)

PARAMETER	SYMBOL	TEST CONDITIONS	MIN	TYP	MAX	UNIT
Operating Input Voltage	V_{op}		2.5		7	V
Output Voltage	V_o	$V_i=2.5\text{V}$	1.477	1.5	1.523	V
		$I_o=1 \sim 150\text{mA}$	1.455		1.545	V
		$I_o=1 \sim 150\text{mA}$, $T_J=-40 \sim 125^\circ\text{C}$	1.440		1.560	V
Output Voltage	V_o	$V_i=2.8\text{V}$	1.773	1.8	1.827	V
		$I_o=1 \sim 150\text{mA}$	1.746		1.854	V
		$I_o=1 \sim 150\text{mA}$, $T_J=-40 \sim 125^\circ\text{C}$	1.728		1.872	V
Output Voltage	V_o	$V_i=3.5\text{V}$	2.4625	2.5	2.5375	V
		$I_o=1 \sim 150\text{mA}$	2.425		2.575	V
		$I_o=1 \sim 150\text{mA}$, $T_J=-40 \sim 125^\circ\text{C}$	2.4		2.6	V
Output Voltage	V_o	$V_i=3.8\text{V}$	2.758	2.8	2.842	V
		$I_o=1 \sim 150\text{mA}$	2.716		2.884	V
		$I_o=1 \sim 150\text{mA}$, $T_J=-40 \sim 125^\circ\text{C}$	2.688		2.912	V
Output Voltage	V_o	$V_i=3.85\text{V}$	2.807	2.85	2.893	V
		$I_o=1 \sim 150\text{mA}$	2.764		2.935	V
		$I_o=1 \sim 150\text{mA}$, $T_J=-40 \sim 125^\circ\text{C}$	2.736		2.964	V
Output Voltage	V_o	$V_i=4.0\text{V}$	2.955	3.0	3.045	V
		$I_o=1 \sim 150\text{mA}$	2.91		3.09	V
		$I_o=1 \sim 150\text{mA}$, $T_J=-40 \sim 125^\circ\text{C}$	2.88		3.12	V
Output Voltage	V_o	$V_i=4.1\text{V}$	3.0535	3.1	3.1465	V
		$I_o=1 \sim 150\text{mA}$	3.007		3.193	V
		$I_o=1 \sim 150\text{mA}$, $T_J=-40 \sim 125^\circ\text{C}$	2.976		3.224	V
Output Voltage	V_o	$V_i=4.2\text{V}$	3.152	3.2	3.248	V
		$I_o=1 \sim 150\text{mA}$	3.104		3.296	V
		$I_o=1 \sim 150\text{mA}$, $T_J=-40 \sim 125^\circ\text{C}$	3.072		3.328	V
Output Voltage	V_o	$V_i=4.3\text{V}$	3.2505	3.3	3.3495	V
		$I_o=1 \sim 150\text{mA}$	3.201		3.399	V
		$I_o=1 \sim 150\text{mA}$, $T_J=-40 \sim 125^\circ\text{C}$	3.168		3.432	V
Output Voltage	V_o	$V_i=4.5\text{V}$	3.447	3.5	3.552	V
		$I_o=1 \sim 150\text{mA}$	3.395		3.605	V
		$I_o=1 \sim 150\text{mA}$, $T_J=-40 \sim 125^\circ\text{C}$	3.360		3.640	V
Output Voltage	V_o	$V_i=4.6\text{V}$	3.546	3.6	3.654	V
		$I_o=1 \sim 150\text{mA}$	3.492		3.708	V
		$I_o=1 \sim 150\text{mA}$, $T_J=-40 \sim 125^\circ\text{C}$	3.456		3.744	V
Output Voltage	V_o	$V_i=4.8\text{V}$	3.743	3.8	3.857	V
		$I_o=1 \sim 150\text{mA}$	3.686		3.914	V
		$I_o=1 \sim 150\text{mA}$, $T_J=-40 \sim 125^\circ\text{C}$	3.648		3.952	V
Output Voltage	V_o	$V_i=5.0\text{V}$	3.94	4	4.06	V
		$I_o=1 \sim 150\text{mA}$	3.88		4.12	V
		$I_o=1 \sim 150\text{mA}$, $T_J=-40 \sim 125^\circ\text{C}$	3.84		4.16	V
Output Voltage	V_o	$V_i=5.7\text{V}$	4.6295	4.7	4.7705	V
		$I_o=1 \sim 150\text{mA}$	4.559		4.841	V
		$I_o=1 \sim 150\text{mA}$, $T_J=-40 \sim 125^\circ\text{C}$	4.512		4.888	V
Output Voltage	V_o	$V_i=6.0\text{V}$	4.925	5	5.075	V
		$I_o=1 \sim 150\text{mA}$	4.85		5.15	V

UTC LD1985 LINEAR INTEGRATED CIRCUIT

PARAMETER	SYMBOL	TEST CONDITIONS	MIN	TYP	MAX	UNIT
		$I_o=1 \sim 150\text{mA}$, $T_J=-40 \sim 125^\circ\text{C}$	4.8		5.2	V
Short Circuit Current	Isc	$R_L=0$		400		mA
Line Regulation	$\Delta V_o/\Delta V_i$	$V_i=V_o+1\text{V} \sim 16\text{V}$, $I_o=1\text{mA}$		0.03	0.014	%/V _i
		$V_i=V_o+1\text{V} \sim 16\text{V}$, $I_o=1\text{mA}$ $T_J=-40 \sim 125^\circ\text{C}$			0.032	%/V _i
Dropout Voltage	V _d	$I_o=0$		1	3	mV
		$T_J=-40 \sim 125^\circ\text{C}$, $I_o=0$			5	mV
		$I_o=1\text{mA}$		7	10	mV
		$I_o=1\text{mA}$, $T_J=-40 \sim 125^\circ\text{C}$			15	mV
		$I_o=10\text{mA}$		40	60	mV
		$I_o=10\text{mA}$, $T_J=-40 \sim 125^\circ\text{C}$			90	mV
		$I_o=50\text{mA}$		120	150	mV
		$I_o=50\text{mA}$, $T_J=-40 \sim 125^\circ\text{C}$			225	mV
		$I_o=150\text{mA}$		280	350	mV
		$I_o=150\text{mA}$, $T_J=-40 \sim 125^\circ\text{C}$			575	mV
Quiescent Current	I _d	$I_o=0$		80	100	μA
		$T_J=-40 \sim 125^\circ\text{C}$, $I_o=0$			150	μA
		$I_o=1\text{mA}$		100	150	μA
		$I_o=1\text{mA}$, $T_J=-40 \sim 125^\circ\text{C}$			200	μA
		$I_o=10\text{mA}$		200	300	μA
		$I_o=10\text{mA}$, $T_J=-40 \sim 125^\circ\text{C}$			400	μA
		$I_o=50\text{mA}$		600	900	μA
		$I_o=50\text{mA}$, $T_J=-40 \sim 125^\circ\text{C}$			1200	μA
		$I_o=150\text{mA}$		2000	3000	μA
		$I_o=150\text{mA}$, $T_J=-40 \sim 125^\circ\text{C}$			4000	μA
		OFF MODE $V_{INH}<0.18\text{V}$		0		μA
		OFF MODE $V_{INH}<0.18\text{V}$ $T_J=-40 \sim 125^\circ\text{C}$			2	μA
Supply Voltage Rejection	SVR	$C_{BYP}=0.01 \mu\text{F}$, $C_o=10 \mu\text{F}$, $f=1\text{KHz}$		45		dB
Control Input Logic Low	V _{IL}	$T_J=-40 \sim 125^\circ\text{C}$			0.15	V
Control Input Logic High	V _{IH}	$T_J=-40 \sim 125^\circ\text{C}$	2			V
Control Input Current	I _{INH}	$T_J=-40 \sim 125^\circ\text{C}$, $V_{SHDN}=5\text{V}$		5	15	μA
		$T_J=-40 \sim 125^\circ\text{C}$, $V_{SHDN}=0\text{V}$		0	-1	μA
Output Noise Voltage	e _N	$B=300\text{Hz} \sim 50\text{KHz}$ $C_{BYP}=0.01 \mu\text{F}$, $C_o=10 \mu\text{F}$		30		μV

UTC LD1985 LINEAR INTEGRATED CIRCUIT

TYPICAL CHARACTERISTICS ($T_J=25^{\circ}\text{C}$, $C_i=1\ \mu\text{F}$, $C_o=2.2\ \mu\text{F}$, $C_{BYP}=100\text{nF}$, unless otherwise specified)

UTC LD1985 LINEAR INTEGRATED CIRCUIT

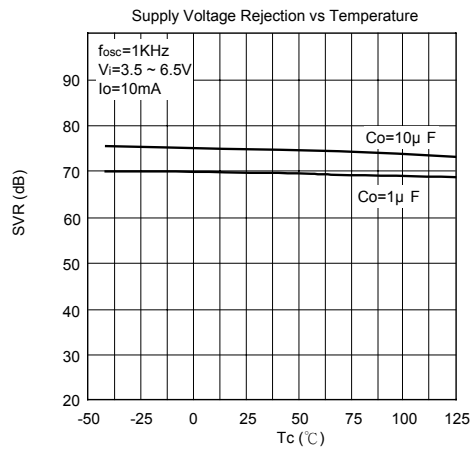
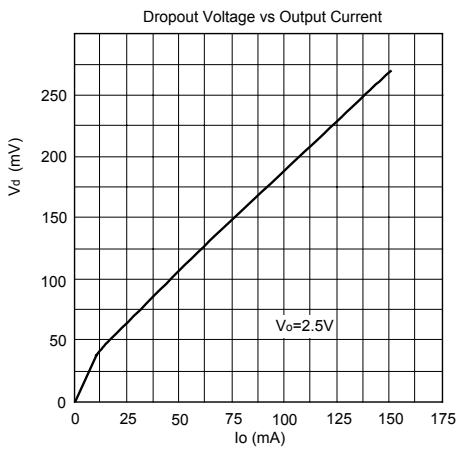
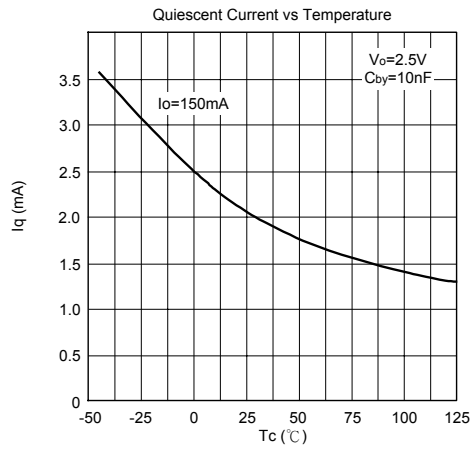
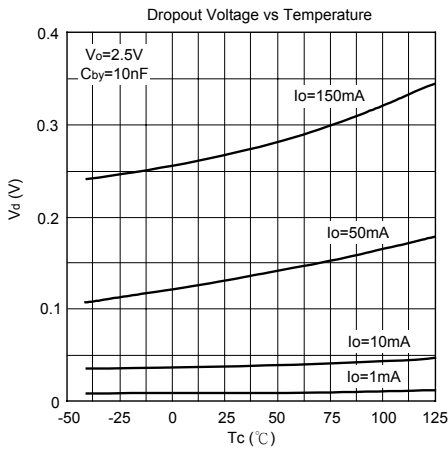
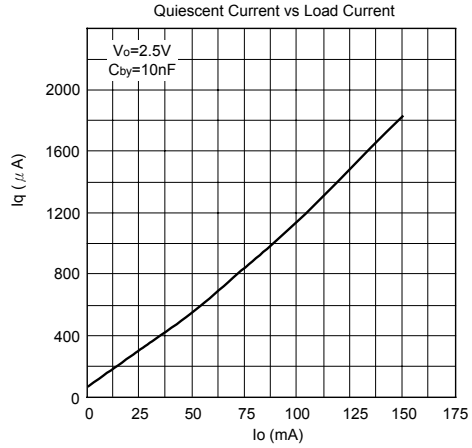
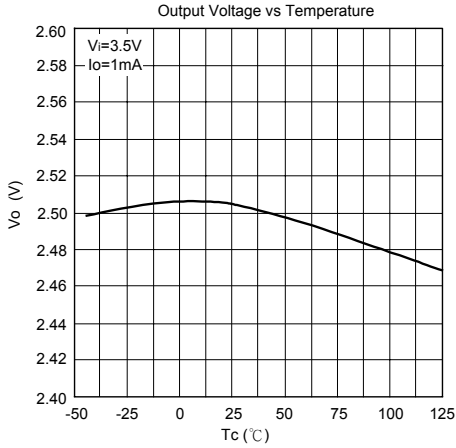

UTC LD1985 LINEAR INTEGRATED CIRCUIT

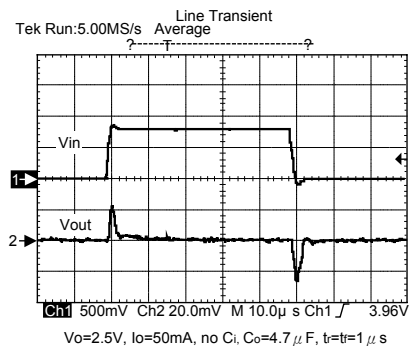
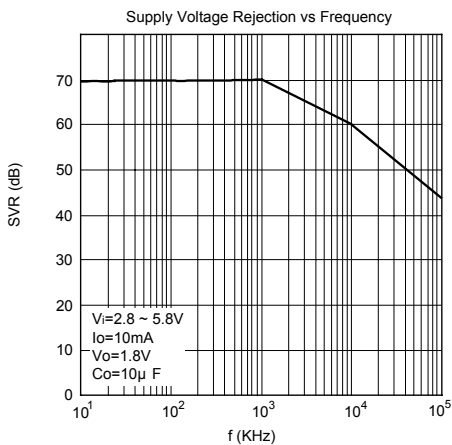
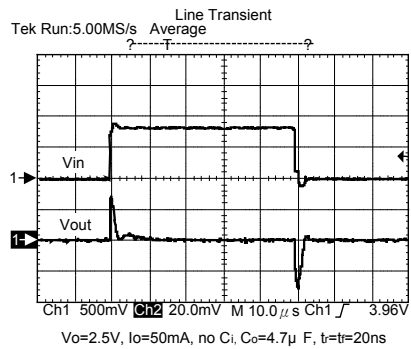
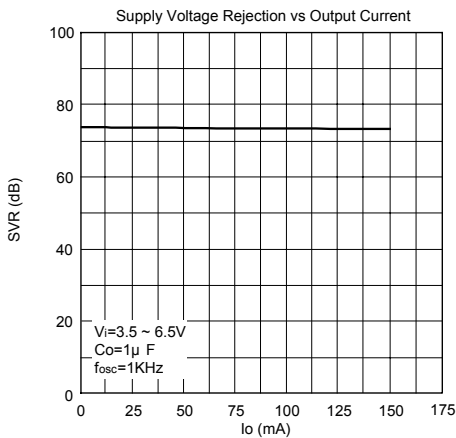
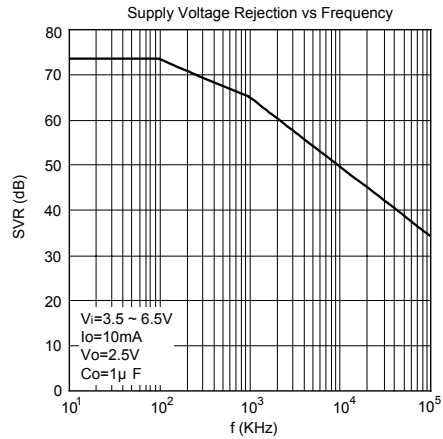
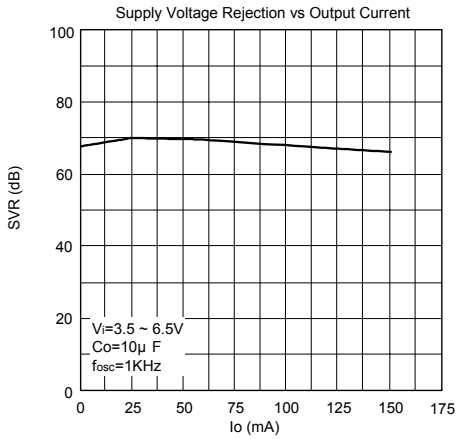

UTC LD1985 LINEAR INTEGRATED CIRCUIT

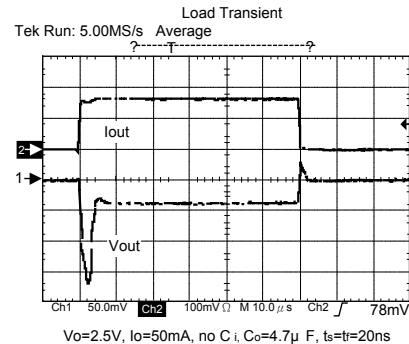
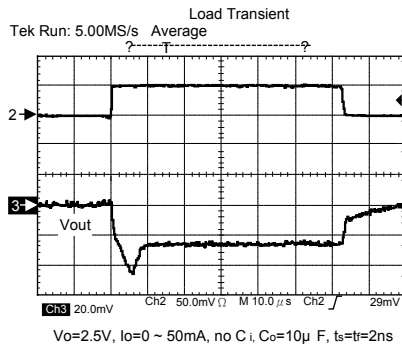

APPLICATION INFORMATION

EXTERNAL CAPACITORS

Like any low-dropout regulator, the UTC LD1985 requires external capacitors for regulator stability. This capacitor must be selected to meet the requirements of minimum capacitance and equivalent series resistance. We suggest to solder input and output capacitors as close as possible to the relative pins.

INPUT CAPACITOR

An input capacitor whose value is $1\mu\text{F}$ is required with the UTC LD1985 (amount of capacitance can be increased without limit). This capacitor must be located a distance of not more than 0.5" from the input pin of the device and returned to a clean analog ground. Any good quality ceramic, tantalum or film capacitors can be used for this capacitor.

OUTPUT CAPACITOR

The UTC LD1985 is designed specifically to work with ceramic output capacitors. It may also be possible to use Tantalum capacitors, but these are not as attractive for reasons of size and cost. By the way, the output capacitor must meet both the requirement for minimum amount of capacitance and E.S.R. (equivalent series resistance) value. Due to the different loop gain, the stability improves for higher output versions and so the suggested minimum output capacitor value, if low E.S.R. ceramic type is used, is $1\mu\text{F}$ for output voltages equal or major than 3.8V, $2.2\mu\text{F}$ for V_o going from 1.8 ~ 3.3V, and $3.3\mu\text{F}$ for the other versions. However, if an output capacitor lower than the suggested one is used, it's possible to make stable the regulator adding a resistor in series to the capacitor.

IMPORTANT:

The output capacitor must maintain its ESR in the stable region over the full operating temperature to assure stability. Also, capacitor tolerance and variation with temperature must be considered to assure the minimum amount of capacitance is provided at all times. This capacitor should be located not more than 0.5" from the output pin of the device and returned to a clean analog ground.

INHIBIT INPUT OPERATION

The inhibit pin can be used to turn OFF the regulator when pulled low, so drastically reducing the current consumption down to less than $1\mu\text{A}$. When the inhibit feature is not used, this pin must be tied to V_i to keep the regulator output ON at all times. To assure proper operation, the signal source used to drive the inhibit pin must be able to swing above and below the specified thresholds listed in the electrical characteristics section under V_{IH} V_{IL} . Any slew rate can be used to drive the inhibit.

REVERSE CURRENT

The power transistor used in the UTC LD1985 has not an inherent diode connected between the regulator input and output. If the output is forced above the input, no current will flow from the output to the input across the series pass transistor. When a V_{REV} voltage is applied on the output, the reverse current measured flows to the GND across the two feedback resistors. This current typical value is $160\mu\text{A}$. R_1 and R_2 resistors are implanted type;

UTC LD1985 LINEAR INTEGRATED CIRCUIT

Typical values are, respectively, 42.6 K Ω and 51.150 K Ω .

Reverse Current Test Circuit

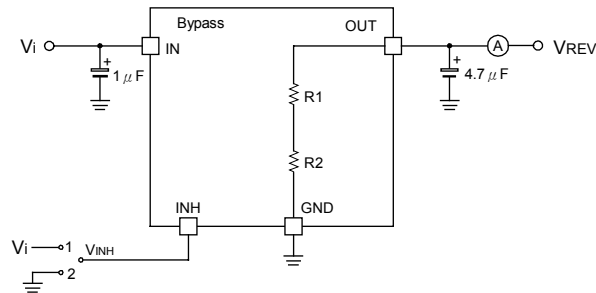

UTC assumes no responsibility for equipment failures that result from using products at values that exceed, even momentarily, rated values (such as maximum ratings, operating condition ranges, or other parameters) listed in products specifications of any and all UTC products described or contained herein. UTC products are not designed for use in life support appliances, devices or systems where malfunction of these products can be reasonably expected to result in personal injury. Reproduction in whole or in part is prohibited without the prior written consent of the copyright owner. The information presented in this document does not form part of any quotation or contract, is believed to be accurate and reliable and may be changed without notice.